



F/T Transducer

**Six-Axis
Force/Torque Sensor System**

Installation and Operation Manual



Document #: 9620-05-Transducer Section

Engineered Products for Robotic Productivity

Pinnacle Park • 1041 Goodworth Drive • Apex, NC 27539 • Tel: +1-919.772.0115 • Fax: +1-919.772.8259 • www.ati-ia.com

Foreword

Information contained in this document is the property of ATI Industrial Automation, Inc. and shall not be reproduced in whole or in part without prior written approval of ATI Industrial Automation, Inc. The information herein is subject to change without notice and should not be construed as a commitment on ATI Industrial Automation, Inc. This manual is periodically revised to reflect and incorporate changes made to the F/T system.

ATI Industrial Automation, Inc. assumes no responsibility for any errors or omissions in this document. Users' critical evaluation is welcome to assist in the preparation of future documentation.

Copyright© 2022 by ATI Industrial Automation. All rights reserved.

ATI Force/Torque Sensing Systems are considered components / semi-finished goods intended for use in a larger system / device / finished good.

In consideration that ATI Industrial Automation, Inc (ATI) products are intended for use with robotic and/or automated machines, ATI does not recommend the use of its products for applications wherein failure or malfunction of an ATI component or system threatens life or makes injury probable. Anyone who uses or incorporates ATI components within any potentially life threatening system must obtain ATI's prior consent based upon assurance to ATI that a malfunction of ATI's component does not pose direct or indirect threat of injury or death, and (even if such consent is given) shall indemnify ATI from any claim, loss, liability, and related expenses arising from any injury or death resulting from use of ATI components.

All trademarks belong to their respective owners.

Windows is registered trademarks of Microsoft Corporation.

Note

Please read the manual before calling customer service. Before calling, have the following information available:

1. Serial number (e.g., FT01234)
2. Transducer model (e.g., Nano17, Gamma, Theta, etc.)
3. Calibration (e.g., US-15-50, SI-65-6, etc.)
4. Accurate and complete description of the question or problem
5. Computer and software information. Operating system, PC type, drivers, application software, and other relevant information about the configuration.

If possible, be near the F/T system when calling.

For additional information or assistance, please refer to the following contacts:

Sale, Service and Information about ATI products:

ATI Industrial Automation

1041 Goodworth Drive

Apex, NC 27539 USA

www.ati-ia.com

Tel: +1.919.772.0115

Fax: +1.919.772.8259

Application Engineering

Tel: +1.919.772.0115, Extension 511

Fax: +1.919.772.8259

E-mail: ft_support@ati-ia.com

Table of Contents

Foreword	2
Glossary	9
1. Safety	11
1.1 Explanation of Notifications	11
1.2 General Safety Guidelines	11
1.3 Safety Precautions	11
2. Product Overview	12
3. Installing the Transducer	13
3.1 Transducer Environment	13
3.2 Mounting the Transducer	13
3.2.1 Interface Plate Design	13
3.2.2 Mounting the Transducer with a Removable Mounting Adapter Plate	15
3.2.3 Mounting the Transducer with a Non-removable Adapter Plate	17
3.3 Routing the Transducer Cable	18
4. Operation Topics	20
4.1 Accuracy over Temperature	20
4.2 Tool Transformation Effects	20
4.3 Environmental	21
4.4 Mux Transducer Input Filter Frequency Response	22
4.5 Transducer Strain Gage Saturation	22
5. Transducer Specifications	23
5.1 Notes on the Specification Section	23
5.1.1 ATI Website	23
5.1.2 About CTL Calibration Specifications	23
5.1.3 Complex Loading Graph Description	23
5.2 Nano17 Titanium	24
5.2.1 Nano17 Titanium Physical Properties	24
5.2.2 Calibration Specifications (excludes CTL calibrations)	25
5.2.3 CTL Calibration Specifications	25
5.2.4 CTL Analog Output	26
5.2.5 CTL Counts Value	26
5.2.6 Nano17 Titanium (US Calibration Complex Loading)	27
5.2.7 Nano17 Titanium (SI Calibration Complex Loading)	28
5.3 Nano17 Specifications (Includes IP65/IP68 Versions)	29
5.3.1 Nano17 Physical Properties	29
5.3.2 Nano17 IP65/IP68 Physical Properties	30

5.3.3	Calibration Specifications (excludes CTL calibrations)	31
5.3.4	CTL Calibration Specifications	31
5.3.5	CTL Analog Output	32
5.3.6	CTL Counts Value	32
5.3.7	Nano17 (US Calibration Complex Loading)(Includes IP65/IP68) ¹	33
5.3.8	Nano17 (SI Calibration Complex Loading)(Includes IP65/IP68) ¹	34
5.4	Nano25 Specifications (Includes IP65/IP68 Versions)	35
5.4.1	Nano25 Physical Properties	35
5.4.2	Nano25 IP65/IP68 Physical Properties	36
5.4.3	Calibration Specifications (excludes CTL calibrations)	37
5.4.4	CTL Calibration Specifications	37
5.4.5	CTL Analog Output	38
5.4.6	CTL Counts Value	38
5.4.7	Nano25 (US Calibration Complex Loading)(Includes IP65/IP68) ¹	39
5.4.8	Nano25 (SI Calibration Complex Loading)(Includes IP65/IP68) ¹	40
5.5	Nano43 Specifications	41
5.5.1	Nano43 Physical Properties	41
5.5.2	Calibration Specifications (excludes CTL calibrations)	42
5.5.3	CTL Calibration Specifications	42
5.5.4	CTL Analog Output	43
5.5.5	CTL Counts Value	43
5.5.6	Nano43 (US Calibration Complex Loading)	44
5.5.7	Nano43 (SI Calibration Complex Loading)	45
5.6	Mini27 Titanium Specifications	46
5.6.1	Mini27 Titanium Physical Properties	46
5.6.2	Calibration Specifications (excludes CTL calibrations)	47
5.6.3	CTL Calibration Specifications	47
5.6.4	CTL Analog Output	48
5.6.5	CTL Counts Value	48
5.6.6	Mini27 Titanium (US Calibration Complex Loading)	49
5.6.7	Mini27 Titanium (SI Calibration Complex Loading)	50
5.7	Mini40 Specifications (Includes IP65/IP68 Versions)	51
5.7.1	Mini40 Physical Properties	51
5.7.2	Mini40 IP65/IP68 Physical Properties	52
5.7.3	Calibration Specifications (excludes CTL calibrations)	53
5.7.4	CTL Calibration Specifications	54
5.7.5	CTL Analog Output	54
5.7.6	CTL Counts Value	54
5.7.7	Mini40 (US Calibration Complex Loading)(Includes IP65/IP68) ¹	55

5.7.8	Mini40 (SI Calibration Complex Loading)(Includes IP65/IP68) ¹	56
5.8	Mini43LP Specifications	57
5.8.1	Mini43LP Physical Properties.....	57
5.8.2	Calibration Specifications	57
5.8.3	CTL Analog Output.....	58
5.8.4	CTL Counts Value	58
5.8.5	Mini43LP (US Calibration Complex Loading).....	59
5.8.6	Mini43LP (SI Calibration Complex Loading)	60
5.9	Mini45 Titanium Specifications	61
5.9.1	Mini45 Titanium Physical Properties	61
5.9.2	Calibration Specifications (excludes CTL calibrations)	62
5.9.3	CTL Calibration Specifications	62
5.9.4	CTL Analog Output.....	63
5.9.5	CTL Counts Value	63
5.9.6	Mini45 Titanium (US Calibration Complex Loading).....	64
5.9.7	Mini45 Titanium (SI Calibration Complex Loading)	65
5.10	Mini45 Specifications (Includes IP65/IP68 Versions)	66
5.10.1	Mini45 Physical Properties	66
5.10.2	Mini45 IP65/IP68 Physical Properties	67
5.10.3	Calibration Specifications (excludes CTL calibrations)	68
5.10.4	CTL Calibration Specifications	68
5.10.5	CTL Analog Output.....	69
5.10.6	CTL Counts Value	69
5.10.7	Mini45 (US Calibration Complex Loading)(Includes IP65/IP68) ¹	70
5.10.8	Mini45 (SI Calibration Complex Loading)(Includes IP65/IP68) ¹	71
5.11	Mini58 Specifications (Includes IP60/IP65/IP68 Versions).....	72
5.11.1	Mini58 Physical Properties	72
5.11.2	Mini58 IP60 Physical Properties.....	73
5.11.3	Mini58 IP65/IP68 Physical Properties	73
5.11.4	Calibration Specifications (excludes CTL calibrations)	74
5.11.5	CTL Calibration Specifications	75
5.11.6	CTL Analog Output.....	75
5.11.7	CTL Counts Value	76
5.11.8	Tool Transform Factor	76
5.11.9	Mini58 (US Calibration Complex Loading)(Includes IP60/IP65/IP68) ¹	77
5.11.10	Mini58 (SI Calibration Complex Loading)(Includes IP60/IP65/IP68) ¹	78
5.12	Mini85 Specifications.....	79
5.12.1	Mini85 Physical Properties	79

5.12.2	Calibration Specifications (excludes CTL calibrations)	80
5.12.3	CTL Calibration Specifications	80
5.12.4	CTL Analog Output	81
5.12.5	CTL Counts Value	82
5.12.6	Tool Transform Factor	82
5.12.7	Mini85 (US Calibration Complex Loading)(Includes IP60)	83
5.12.8	Mini85 (SI Calibration Complex Loading)(Includes IP60)	84
5.13	Gamma Specifications (Includes IP60/IP65/IP68 Versions)	85
5.13.1	Gamma Physical Properties	85
5.13.2	Gamma IP60 Physical Properties	86
5.13.3	Gamma IP65 Physical Properties	86
5.13.4	Gamma IP68 Physical Properties	87
5.13.5	Calibration Specifications (excludes CTL calibrations)	88
5.13.6	CTL Calibration Specifications	88
5.13.7	CTL Analog Output	89
5.13.8	CTL Counts Value	90
5.13.9	Tool Transform Factor	90
5.13.10	Gamma (US Calibration Complex Loading) (Includes IP60/IP65/IP68) ¹	91
5.13.11	Gamma (SI Calibration Complex Loading) (Includes IP60/IP65/IP68) ¹	92
5.14	Delta Specifications (Includes IP60/IP65/IP68 Versions)	93
5.14.1	Delta Physical Properties	93
5.14.2	Delta IP60 Physical Properties	94
5.14.3	Delta IP65 Physical Properties	94
5.14.4	Delta IP68 Physical Properties	95
5.14.5	Calibration Specifications (excludes CTL calibrations)	96
5.14.6	CTL Calibration Specifications	96
5.14.7	CTL Analog Output	97
5.14.8	CTL Counts Value	97
5.14.9	Delta (US Calibration Complex Loading)(Includes IP60/IP65/IP68) ¹	98
5.14.10	Delta (SI Calibration Complex Loading)(Includes IP60/IP65/IP68) ¹	99
5.15	Theta Specifications (Includes IP60/IP65/IP68 Versions)	100
5.15.1	Theta Physical Properties	100
5.15.2	Theta IP60 Physical Properties	101
5.15.3	Theta IP65/IP68 Physical Properties	101
5.15.4	Calibration Specifications (excludes CTL calibrations)	103
5.15.5	CTL Calibration Specifications	103
5.15.6	CTL Analog Output	104

5.15.7	CTL Counts Value	104
5.15.8	Tool Transform Factor	104
5.15.9	Theta (US Calibration Complex Loading)(Includes IP60/IP65/IP68) ¹	105
5.15.10	Theta (SI Calibration Complex Loading)(Includes IP60/IP65/IP68) ¹	106
5.16	Omega85 Specifications (Includes IP60/IP65/IP68 Versions).....	107
5.16.1	Omega85 Physical Properties.....	107
5.16.2	Omega85 IP65/IP68 Physical Properties	108
5.16.3	Calibration Specifications (excludes CTL calibrations)	109
5.16.4	Omega85 (US Calibration Complex Loading)(Includes IP65/IP68) ¹	110
5.17	Omega160 Specifications (Includes IP60/IP65/IP68 Versions).....	111
5.17.1	Omega160 Physical Properties.....	111
5.17.2	Omega160 IP160 Physical Properties (Includes ECAT)	112
5.17.3	Omega160 IP65/IP68 Physical Properties	112
5.17.4	Calibration Specifications (excludes CTL calibrations)	114
5.17.5	CTL Calibration Specifications	114
5.17.6	CTL Analog Output.....	115
5.17.7	CTL Counts Value	115
5.17.8	Tool Transform Factor	115
5.17.9	Omega160 (US Calibration Complex Loading) (Includes IP60/IP65/IP68) ¹	116
5.17.10	Omega160 (SI Calibration Complex Loading) (Includes IP60/IP65/IP68) ¹	117
5.18	Omega190 Specifications.....	118
5.18.1	Omega190 Physical Properties.....	118
5.18.2	Calibration Specifications (excludes CTL calibrations)	119
5.18.3	CTL Calibration Specifications	119
5.18.4	CTL Analog Output.....	120
5.18.5	CTL Counts Value	120
5.18.6	Omega190 (US Calibration Complex Loading).....	121
5.18.7	Omega190 (SI Calibration Complex Loading).....	122
5.19	Omega191 Specifications (Includes IP60/IP65/IP68 Versions).....	123
5.19.1	Omega191 Physical Properties.....	123
5.19.2	Omega191 IP60 Physical Properties	124
5.19.3	Omega191 IP65/IP68 Physical Properties	124
5.19.4	Calibration Specifications (excludes CTL calibrations)	126
5.19.5	CTL Calibration Specifications	126
5.19.6	CTL Analog Output.....	127
5.19.7	CTL Counts Value	127
5.19.8	Omega191 (US Calibration Complex Loading) (Includes IP60/IP65/IP68) ¹	128

5.19.9	Omega191 (SI Calibration Complex Loading) (Includes IP60/IP65/IP68) ¹	129
5.20	Omega250 Specifications (Includes IP60/IP65/IP68)	130
5.20.1	Omega250 Physical Properties (Includes IP60/IP65/IP68).....	130
5.20.2	Calibration Specifications (excludes CTL calibrations)	131
5.20.3	CTL Calibration Specifications	131
5.20.4	CTL Analog Output	132
5.20.5	CTL Counts Value	132
5.20.6	Omega250 (US Calibration Complex Loading) (Includes IP60/IP65/IP68) ¹	133
5.20.7	Omega250 (SI Calibration Complex Loading) (Includes IP60/IP65/IP68) ¹	134
5.21	Omega331 Specifications (Includes IP65)	135
5.21.1	Omega331 Physical Properties (Includes IP65).....	135
5.21.2	Calibration Specifications (excludes CTL calibrations)	136
5.21.3	CTL Calibration Specifications	136
5.21.4	CTL Analog Output	137
5.21.5	CTL Counts Value	137
5.21.6	Omega331 (US Calibration Complex Loading) (Includes IP65).....	138
5.21.7	Omega331 (SI Calibration Complex Loading) (Includes IP65)	139
6.	Diagnostics and Maintenance	140
6.1	Reducing Noise	140
6.1.1	Mechanical Vibration	140
6.1.2	Electrical Interference.....	140
6.2	Detecting Failures (Diagnostics)	140
6.2.1	Detecting Sensitivity Changes.....	140
6.3	Scheduled Maintenance	141
6.3.1	Periodic Inspection	141
6.3.2	Periodic Calibration	141
6.4	A Note on Servicing Transducer Cabling	141
6.4.1	Calibrations	141
6.4.2	Cabling and Connectors.....	141
6.5	Resolution	141
7.	Terms and Conditions of Sale	142

Glossary

Term	Definition
Accuracy	See Measurement Uncertainty.
Calibration Certificate	A statement that says the equipment measures correctly. These statements usually mean the equipment has been tested against national standards. The statements are produced as a result of calibration or re-calibration.
Calibration	The act of measuring a transducer's raw response to loads and creating data used in converting the response to forces and torques.
Compound Loading	Any load that is not purely in one axis.
Coordinate Frame	See Point of Origin
DAQ F/T	An F/T Sensor System that uses industry standard data acquisition fasteners (usually computer cards) to convert the transducer signals into digital data.
DAQ	Data Acquisition device.
DoF	Degrees of Freedom. See Six Degrees of Freedom.
F/T Controller	The electronics that connect to mux transducers.
F/T	Force and Torque.
Force	The push or pull exerted on an object.
FS	Full-Scale
Full-Scale Error	A measurement of sensing error. For example, if the calibrated measurement range of a sensor is 100 Newtons and the sensor is accurate to within 1 Newton, that sensor will have a Full-Scale Error of 1% (1% = 0.01 = 1 N / 100 N).
Fxy	The resultant force vector comprised of components Fx and Fy.
Hysteresis	A source of measurement error caused by the residual effects of previously applied loads.
IP60	Ingress Protection Rating "60" designates protection against dust
IP65	Ingress Protection Rating "65" designates protection against water spray
IP68	Ingress Protection Rating "68" designates submergibility in fresh water, in this case, to a depth of 10 meters
MAP	Mounting Adapter Plate. The transducer's MAP attaches to the fixed surface or robot arm.
Max. Single-Axis Overload	The largest amount of load in a single axis (all other axes are unloaded) that the transducer can withstand without damage.
Measurement Uncertainty	The maximum expected error in measurements, as specified on the calibration certificate.
Moment	When something receives a torque, we say a moment is applied to it.
Mux Box	A box that holds mux electronics for transducers that are too small for on-board electronics.
Mux	Short for multiplexer. F/T Controller Sensor Systems use mux electronics to interface to the transducer signals.
Net F/T	An F/T Sensor System that connects to the customer's monitoring equipment via Ethernet or CAN bus or DeviceNet.
Offset Compensation	Correction of errors that change the zero point of a transducer's readings.
Overload	The condition where more load is applied to the transducer than it can measure. This will result in saturation.
Point of Origin	The point on the transducer from which all forces and torques are measured.

Term	Definition
Quantization	The way the continuously variable transducer signal is converted into discreet digital values. Usually used when describing the change from one digital value to the next.
Re-calibration	The periodic verification of measurement equipment, like transducers, calipers and voltmeters, to prove it still measures correctly. The equipment may be adjusted if it doesn't measure correctly.
Reaction Torque	Torque applied that does not result in movement. Think of the twisting you attempt to put on a screw or bolt when it does not move. ATI transducers sense reaction torque.
Resolution	The smallest change in load that can be measured. This is usually much smaller than accuracy.
Rotary Torque	Torque resulting in something moving. Generally this refers to the torque on things like drive shafts. ATI transducers cannot sense rotational torque.
Saturation	The condition where the transducer or data acquisition fasteners has a load or signal outside of its sensing range.
Sensor System	The entire assembly consisting of parts from transducer to data acquisition card.
Six Degrees of Freedom	Fx, Fy, Fz, Tx, Ty and Tz.
Six-axis Force/Torque Sensor	A device that measures the outputting forces and torques from all three Cartesian coordinates (x, y and z). A six-axis force/torque transducer is also known as a multi-axis force/torque transducer, multi-axis load cell, F/T sensor, or six-axis load cell.
Span Compensation	Correction of errors that affect the sensitivity of a transducer.
TAP	Tool Adapter Plate. The TAP part of the transducer is attached to the load that is to be measured.
Tool Transformation	Mathematically changing the measurement coordinate system by translating the origin and/or rotating the axes.
Torque	The measurement of force exerted on an object causing it to rotate.
Transducer	The component that converts the sensed load into electrical signals.
Txy	The resultant torque vector comprised of components Tx and Ty.

1. Safety

The safety section describes general safety guidelines to be followed with this product, explanations of the notifications found in this manual, and safety precautions that apply to the product. There is no personnel safety risk associated with the intended design of the products described within this manual. Product specific notifications are imbedded within the sections of this manual (where they apply).

1.1 Explanation of Notifications

These notifications are used in all of ATI manuals and are not specific to this product. The user should heed all notifications from the robot manufacturer and/or the manufacturers of other components used in the installation.



DANGER: Notification of information or instructions that if not followed will result in death or serious injury. The notification provides information about the nature of the hazardous situation, the consequences of not avoiding the hazard, and the method for avoiding the situation.



WARNING: Notification of information or instructions that if not followed could result in death or serious injury. The notification provides information about the nature of the hazardous situation, the consequences of not avoiding the hazard, and the method for avoiding the situation.



CAUTION: Notification of information or instructions that if not followed could result in moderate injury or will cause damage to equipment. The notification provides information about the nature of the hazardous situation, the consequences of not avoiding the hazard, and the method for avoiding the situation.

NOTICE: Notification of specific information or instructions about maintaining, operating, installing, or setting up the product that if not followed could result in damage to equipment. The notification can emphasize, but is not limited to: specific grease types, best operating practices, and maintenance tips.

1.2 General Safety Guidelines

The customer should verify that the transducer selected is rated for maximum loads and moments expected during operation. For this information, refer to [Section 5—Transducer Specifications](#) or contact an ATI representative for assistance. Particular attention should be paid to dynamic loads caused by robot acceleration and deceleration. These forces can be many times the value of static forces in high acceleration or deceleration situations.

1.3 Safety Precautions



CAUTION: Do not remove any fasteners or disassemble transducers without a removable mounting adapter plate. These include Nano, Mini, IP-rated, and some Omega transducers. This will cause irreparable damage to the transducer and void the warranty. Leave all fasteners in place and do not disassemble the transducer.



CAUTION: Do not probe any openings in the transducer. This will damage the instrumentation.



CAUTION: Do not exert excessive force on the transducer. The transducer is a sensitive instrument and can be damaged by applying force exceeding the single-axis overload values of the transducer and cause irreparable damage. Small Nano and Mini transducers can easily be overloaded during installation. For specific transducer overload values, refer to [Section 5—Transducer Specifications](#).

2. Product Overview

A transducer is a device that measures the outputting forces and torques from all three Cartesian coordinates (x, y, and z). A six-axis force/torque transducer is also known as a multi-axis force/torque transducer, multi-axis load cell, F/T sensor, or six-axis load cell.

The ATI Multi-Axis Force/Torque (F/T) sensor system measures all six components of force and torque. The system consists of a transducer, shielded high-flex cable, and intelligent data acquisition system (Ethernet/ DeviceNet interface or F/T controller). F/T sensors are used throughout industry for product testing, robotic assembly, grinding, and polishing. In research, ATI sensors are used in robotic surgery, haptics, rehabilitation, neurology, and many others applications.

3. Installing the Transducer

Information on the transducer environment, IP rating, mounting, and routing of the transducer cable are included in the following sections.

3.1 Transducer Environment

To ensure proper operation, the IP rating of the transducer must match or exceed the transducer's environment. Unless otherwise specified, a transducer has no special IP protection. In this case, the transducer may be used only in benign environments with no dust, debris, liquids, or sprays. For information on the transducer's temperature performance, refer to [Section 4.1—Accuracy over Temperature](#).



CAUTION: Damage to the outer jacketing of the transducer cable could enable moisture or water to enter an otherwise sealed transducer. Ensure the cable jacketing is in good condition to prevent transducer damage.

NOTICE: Transducers may react to exceptionally strong and changing electromagnetic fields, such as those produced by magnetic resonance imaging (MRI) machines.

NOTICE: Transducers without an IP protection may exhibit a small offset in readings when exposed to strong light.

3.2 Mounting the Transducer

There are two different mounting methods for transducers. The first method has a fixed bolt pattern on the tool side of the transducer and a removable adapter plate on the mounting (robot or other device) side. The adapter plate needs to be removed from the transducer and machined with the mounting bolt pattern to match the robot or other device. If the device covers the mounting fasteners used to connect the transducer, the removable adapter plate can't be used alone. If this is the case a user designed interface plate is needed between the transducer and the robot or other device. For more details, refer to [Section 3.2.1—Interface Plate Design](#) and [Section 3.2.2—Mounting the Transducer with a Removable Mounting Adapter Plate](#).

The second method is for transducers with non-removable adapter plates with fixed bolt patterns on both the tool and mounting sides of the transducer (Nano, Mini, IP-rated and some Omega transducers). This type may require a user designed interface plate to attach the transducer to the robot or other device. For more information, refer to [Section 3.2.1—Interface Plate Design](#) and [Section 3.2.3—Mounting the Transducer with a Non-removable Adapter Plate](#).



CAUTION: Do not remove any fasteners or disassemble transducers without a removable adapter plate, these include Nano, Mini, IP-rated, and some Omega transducers. Disassembly causes irreparable damage to the transducer and voids the warranty. Leave all fasteners in place and do not disassemble the transducer.

To determine if the adapter plate is removable for a transducer, refer to the product drawings in [Section 5—Transducer Specifications](#). Mount the transducer to a structure with sufficient mechanical strength. Not doing so can lead to sub-optimum performance.

3.2.1 Interface Plate Design

Interface plates may be required between the robot or other device and the transducer and between the transducer and the tooling. If the robot, other device, or tooling covers the mounting fasteners for the transducer, an interface plate is required. Custom interface plates are available from ATI upon request.

There are two types of mounting adapter plate (robot side). For small transducers such as Nano, Mini, IP-rated, and some Omega, the mounting adapter plate is factory installed and should not be removed or machined. The mounting interface plate must be machined with the corresponding bolt pattern and dowel locations, refer to the transducer drawings. Links to drawings are included in [Section 5—Transducer Specifications](#).

Larger transducers have removable mounting adapter plates (refer to [Section 3.2.2—Mounting the Transducer with a Removable Mounting Adapter Plate](#)). Machine the mounting interface plate to match the bolt pattern and dowel hole in the removable mounting adapter plate.

The transducer tooling adapter plate is factory installed and the bolt circle is shown with the transducer in drawings; for links to the drawings, refer to [Section 5—Transducer Specifications](#). Most large F/T tool adapters follow the ISO 9409-1 mounting pattern. Machine the tooling interface plate to attach to this bolt circle.

NOTICE: The tool may not contact any other part of the transducer except the tool mounting surface. If the tool contacts any other part of the transducer, the transducer will not properly sense loads. Make sure the tool mounts to the tool mounting surface and does not contact any other part of the transducer.

If the customer chooses to design and build a mounting or tooling interface plate, consider the following points. Links to the product drawings are in [Section 5—Transducer Specifications](#).

- The interface plate should be designed to include bolt holes for mounting, dowel pins, and a boss for accurate positioning on the robot or other devices and to the adapter plate. These locating features should orient the X and Y axis of the Transducer to the X and Y axis of the robot.
- The thickness of the interface plate must be great enough to provide the necessary thread engagement for the mounting fasteners.
- Mounting fasteners must not be too long. They should not extend through the adapter plate to avoid interference with the electronics inside the transducer. For thread depth, mounting patterns, and other details, refer to the drawings.
- The interface plate must be properly designed to provide rigid mounting for the transducer. The interface plate should not distort under maximum sensor range of the transducer.
- The interface plate design must provide a flat and parallel mounting surface for the transducer.

Figure 3.1—Interface Plate Design Specification

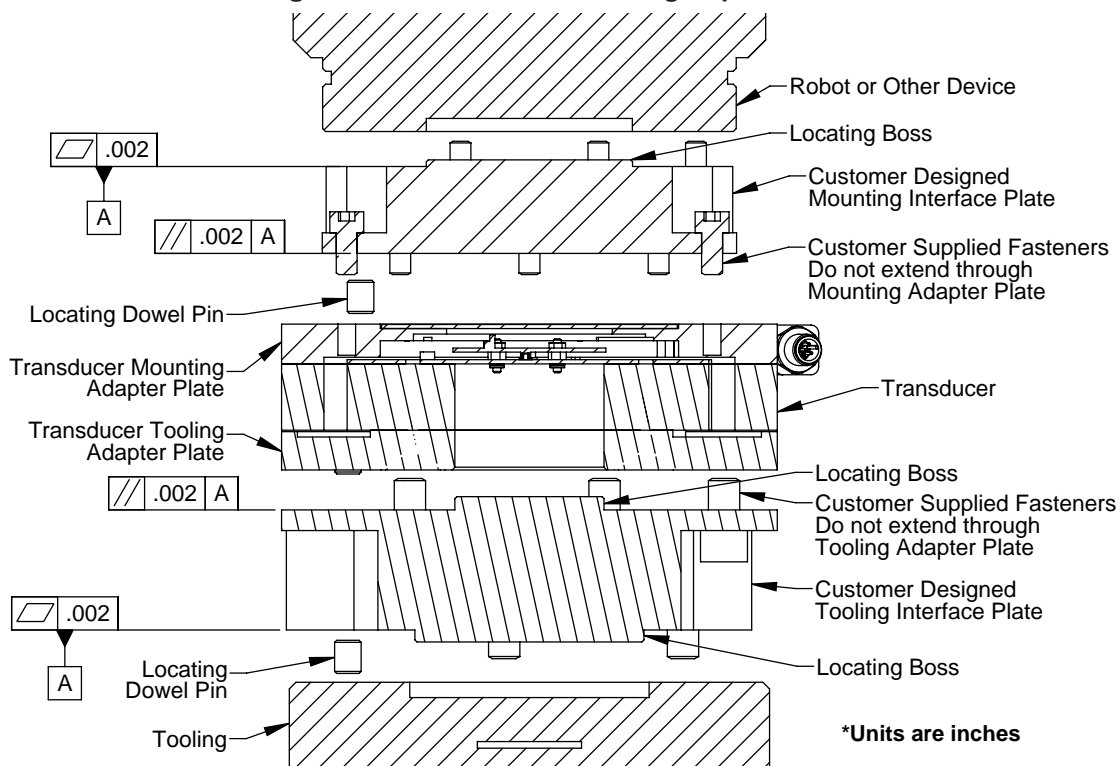

3.2.2 Mounting the Transducer with a Removable Mounting Adapter Plate

First, determine if the transducer can attach directly to the robot/device arm or if an interface plate is needed. If an interface plate is need for the robot side and/or tool side, refer to [Section 3.2.1—Interface Plate Design](#) for details to design an interface plate before continuing with this procedure.

1. Remove power to the transducer.
2. Remove all mounting fasteners from the mounting adapter plate and set aside.



CAUTION: Do not touch internal electronics or instrumentation. This could damage the transducer and void the warranty. When the adapter plate is removed protect the exposed electronics from dust, debris, liquids, and other foreign objects.

3. Remove the adapter plate from the transducer. Machine the mounting bolt pattern from the robot, interface plate, or other device into the removable adapter plate. Make sure the bolt pattern and dowel hole orient the X and Y axis of the transducer with the X and Y axis of the robot.

NOTICE: Customers who machine their own interface patterns should avoid placing all mounting features in the center of the adapter plate. A larger bolt circle provides the most accurate readings because it induces less bending in the plate.



CAUTION: Mounting fasteners should not extend into the transducer beyond the adapter plate surface. This could cause damage to the internal electronics. When machining the removable adapter plate, make sure the heads of the fasteners are flush or below the surface of the adapter plate.

Figure 3.2—Removable Adapter Plate

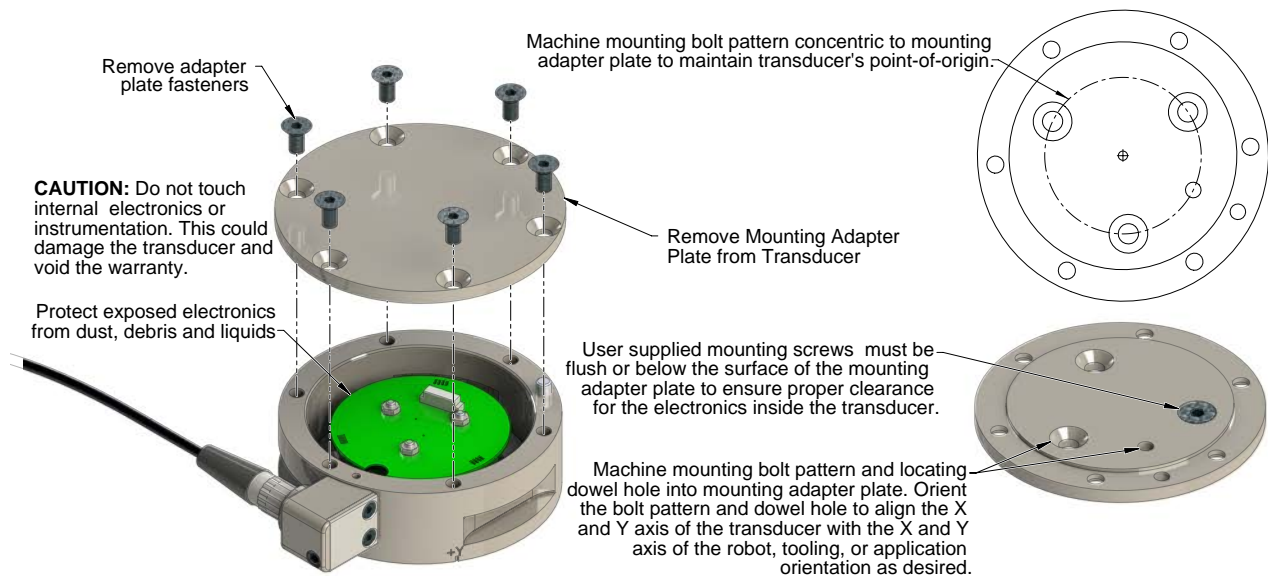

4. Mount removable adapter plate to the robot, other device, or interface plate using customer supplied fasteners. If fasteners do not have pre-applied adhesive, apply Loctite 222® to the fasteners.

NOTICE: Make sure the adapter plate orients the transducer so that the connector is at the appropriate location to route the cabling properly (refer to [Section 3.3—Routing the Transducer Cable](#)).

5. Attach the transducer to the removable adapter plate, hand tighten fasteners.
6. Connect power to the transducer, and wait until demo application displays **load data** when applying force on the transducer.



CAUTION: Do not exceed the transducer's overload ratings. If smaller transducers are not carefully installed, irreparable damage can occur by applying small loads using tools (moment arm increases applied loads). When installing, use the demo application to monitor for gage saturation errors. If an error occurs, stop applying force to the transducer and wait until the error clears to continue installation. If error does not clear, it may indicate loss of power or the overload value has been exceeded.

7. Monitor the demo application for gage saturation errors during installation. If an error is displayed, stop applying the force to the transducer and wait until the error clears. Then continue installation.
8. Tighten the fasteners mounting the transducer to the removable adapter plate.

Figure 3.3—Installing Transducers with Removable Mounting Adapter Plates

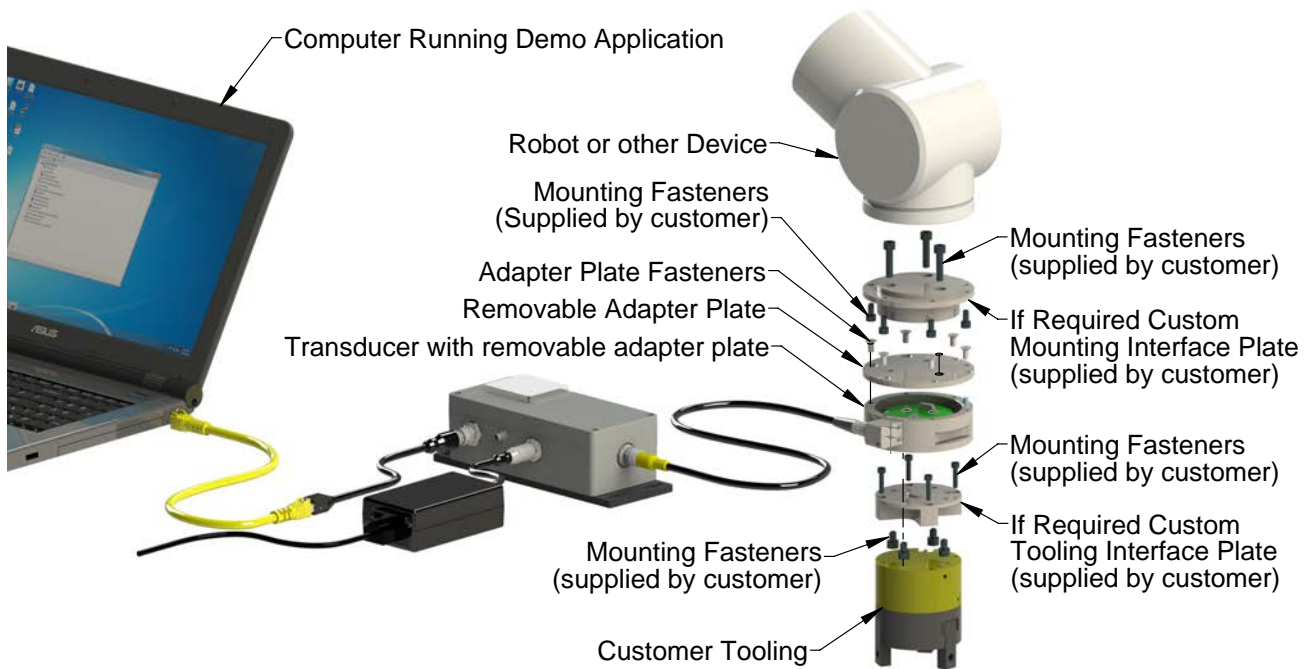

CAUTION: Do not use fasteners that will exceed the customer interface depth specified for the transducer. Using longer fasteners will penetrate the body of the transducer and damage the electronics, voiding the warranty. Use fasteners that provide the customer interface depth specified for the transducer. Refer to the transducer drawing.

NOTICE: The tool may not contact any other part of the transducer except the tool mounting surface. If the tool contacts any other part of the transducer it will not properly sense loads. Make sure the tool mounts to the tool mounting surface and does not contact any other part of the transducer.

9. Monitor the demo application for gage saturation errors during installation. If an error is displayed stop applying the force to the transducer and wait until the error clears before continuing installation.
10. With customer supplied fasteners, attach the customer tooling or tooling interface plate to the transducer. The transducer has a mounting pattern on the tool side of the transducer. If fasteners do not have pre-applied adhesive, apply Loctite 222.

3.2.3 Mounting the Transducer with a Non-removable Adapter Plate



CAUTION: Do not attempt to drill, tap, machine, or otherwise modify or disassemble the transducer. Such work could damage the transducer and will void the warranty. Use the mounting bolt pattern provided to attach the transducer to the robot or other device and to mount the tool to the transducer. See the transducer drawings for details.



CAUTION: Do not use fasteners that will exceed the customer interface depth specified on for the transducer. Using longer fasteners will penetrate the body of the transducer, damage the electronics, and void the warranty. Use fasteners that provide the customer interface depth specified for the transducer. Refer to the transducer drawing.



CAUTION: Do not exceed the transducer's overload ratings. If smaller transducers are not carefully installed, irreparable damage can occur by applying small loads using tools (moment arm increases applied loads). When installing, use the demo application to monitor for gage saturation errors. If an error occurs, stop applying force to the transducer and wait until the error clears to continue installation. If error does not clear, it may indicate loss of power or the overload value has been exceeded.

1. During installation, monitor the demo application for gage saturation errors. If an error is displayed, stop applying the force to the transducer, and wait until the error clears before continuing installation.
2. Mount the transducer to the user-designed interface plate, directly to the robot, or other device with customer supplied fasteners. If fasteners do not have pre-applied adhesive, apply Loctite 222 to the fasteners.

Figure 3.4—Installing Transducers with Non-removable Adapter Plates (Net F/T System Shown)

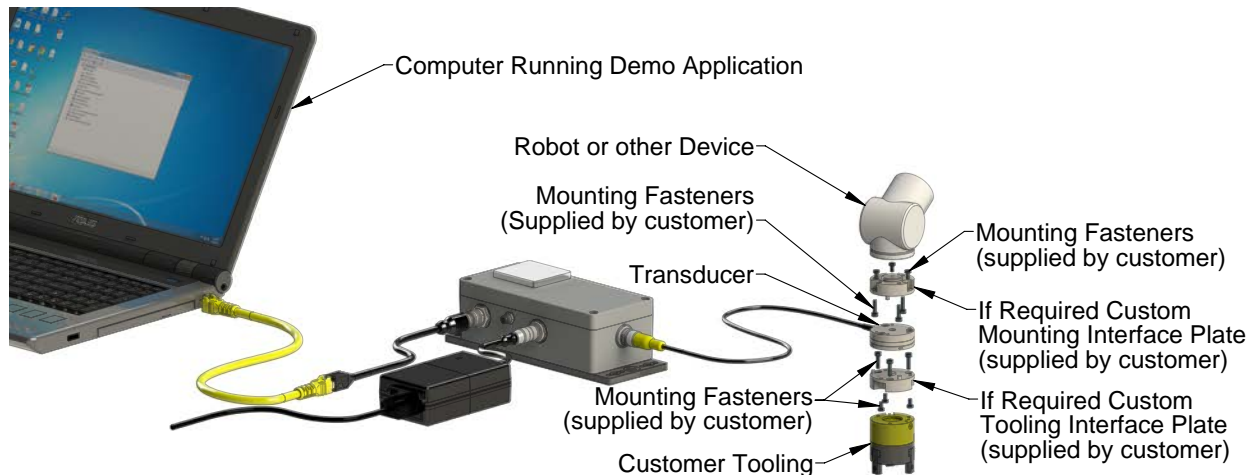

NOTICE: The tool may not touch any other part of the transducer except the tool mounting surface. If the tool touches any other part of the transducer it will not properly sense loads. Make sure the tool mounts to the tool mounting surface and does not touch any other part of the transducer.

3. Monitor the demo application for gage saturation errors during installation. If an error is displayed stop applying the force to the transducer and wait until the error clears before continuing installation.
4. Attach the customer tooling or tooling interface plate to the transducer with customer supplied fasteners, the transducer provides a mounting pattern on the tool side of the transducer. If fasteners do not have pre-applied adhesive, apply Loctite 222 to the fasteners.

3.3 Routing the Transducer Cable

The application for the transducer determines the best cable routing method and the proper cable bending radius. Some applications keep the transducer and cable static. Other applications are dynamic and can put the transducer and cable through repetitive motions. It is important not to expose the transducer cable connectors to this repetitive motion and properly restrain the cable close to the transducer connection

Figure 3.5—Restrain Transducer Cable Close to Cable Connector

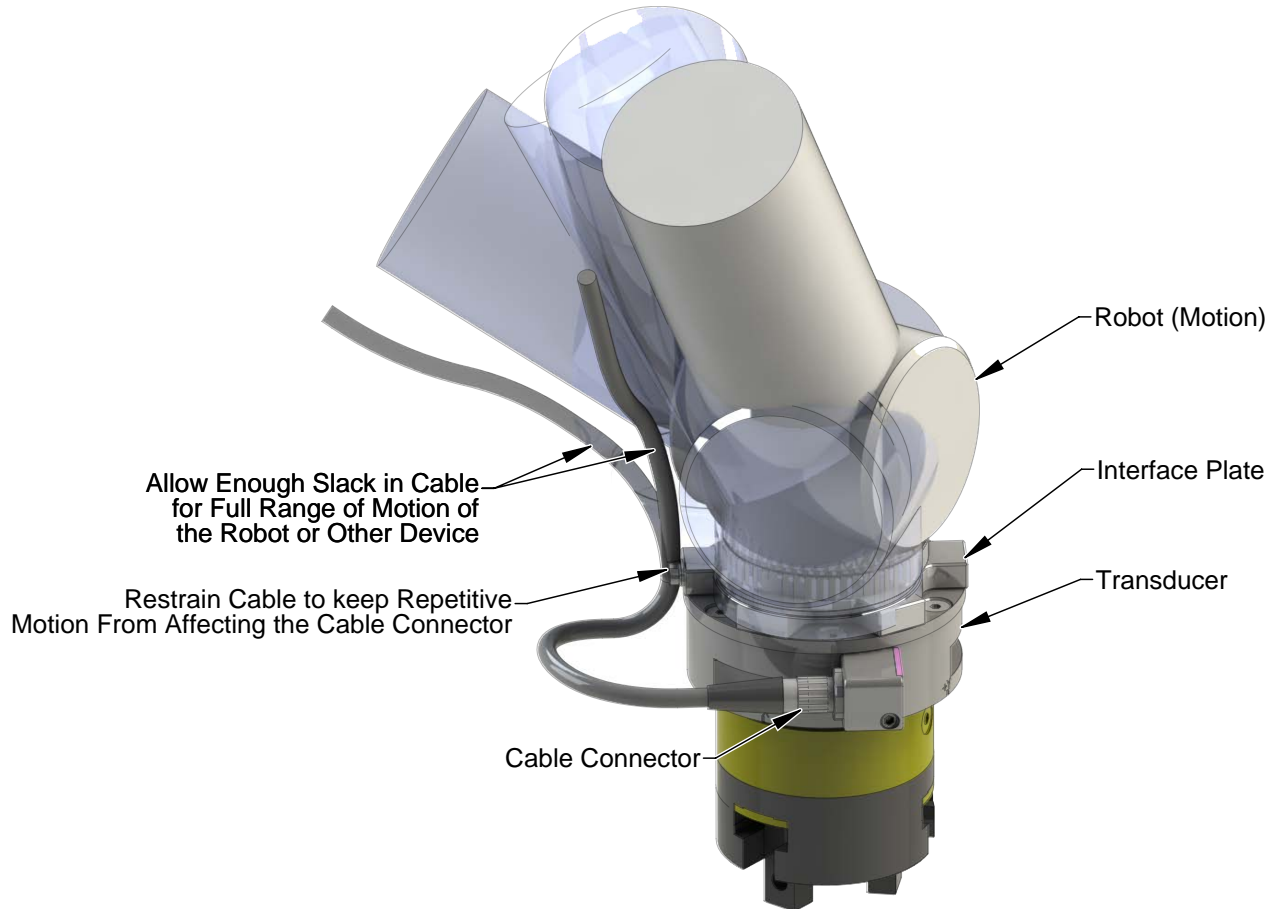

CAUTION: Do not subject the transducer cable connector to the repetitive motion of the robot or other device. Subjecting the connector to the repetitive motion will cause damage to the connector. Restrain the cable close to the connector to keep the repetitive motion of the robot from affecting the cable connector.



CAUTION: When routing cables do not bend the cable to a smaller radius than the minimum bending radius specified in [Table 3.1](#). The cable will fail due to fatigue from the repetitive motion. When routing the cable make sure the cable bends are larger than the minimum dynamic bending radius specified for the cable type.



CAUTION: Do not stress or over bend the transducer cable, especially where it is attached to the transducer. This is particularly important on the Nano and Mini series of transducers. For these transducers, do not bend the cable any closer than 25 mm (1 inch) to the transducer. Sharp bends must be avoided as they can damage the cable and transducer and will void the warranty.

Figure 3.6—Transducer Bending Radius

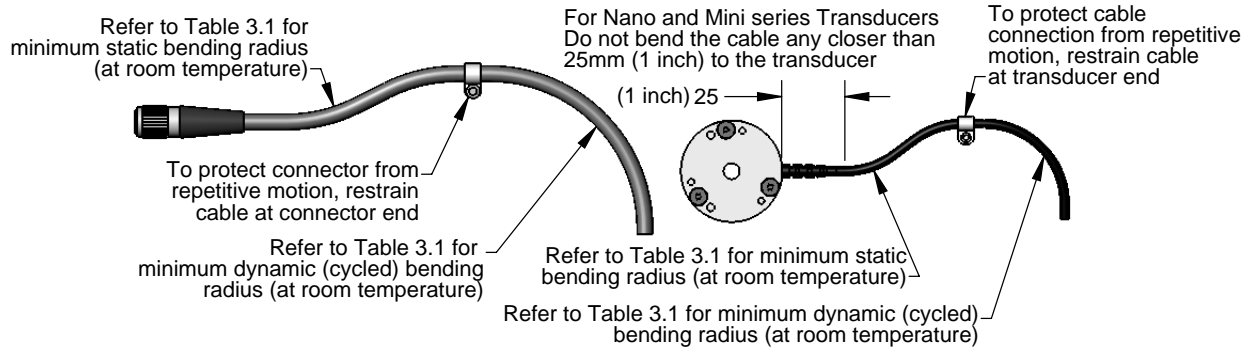





Table 3.1—Transducer Cable Bending Radius

Cable Type	Cable Dia. (mm)	Static Bending Radius (at room temperature)		Dynamic Bending Radius (at room temperature)	
		mm	inch	mm	inch
		9105-TW	3.2	16	0.63
9105-C3	4.4	22	0.87	44	1.73
9105-CM	4.4	22	0.87	44	1.73
9105-CW	4.4	22	0.87	44	1.73
9105-CT	6.1	30.5	1.20	61	2.40
9105-C	3.2	16	0.63	32	1.26
	4.4	22	0.87	44	1.73
	6.1	30.5	1.20	61	2.40
	10.0	50	1.97	100	3.94
9105-C-MTR	8.4	42	1.65	84	3.31
9105-C-MTS	8.4	42	1.65	84	3.31
9105-CF-MTR 9105-CF-MTS	8.5	42.5	1.67	85	3.35

Note: Temperature affects cable flexibility. ATI recommends increasing the minimum dynamic bending radius for lower temperatures.

Route the transducer cable so that it is not stressed, pulled, kinked, cut, or otherwise damaged throughout the full range of motion. See the accompanying system manual for the transducer cable interfacing. If the desired application results in the cable rubbing, then use a loose plastic spiral wrap for protection.

-  **CAUTION:** Be careful not to crush the cable by over tightening tie wraps or walking on the cable, since this may damage the cable.
-  **CAUTION:** Cables on the Nano and Mini transducers are permanently attached to the transducer and cannot be disconnected. Do not attempt to disassemble these transducers, this will damage the transducer and void the warranty. Do not attempt to replace the cable. Contact ATI service for assistance.
-  **CAUTION:** Nano and Mini integral cables and cables of the 9105-C-H type must not subject the transducer end connection to more than 10 lbf (45 N) of side-to-side or pull force or permanent damage will result.
-  **CAUTION:** Larger transducers have removable cables. Do not attempt to disconnect these transducer cables by pulling on the cable itself or the connector boot; this can damage the system.

4. Operation Topics

4.1 Accuracy over Temperature

Typical gain errors introduced over temperature for F/T transducers with fasteners temperature compensation are listed in the following table. Changes in sensitivity are independent of the transducer's rated accuracy at room temperature; add the two accuracy ratings to find an overall estimated accuracy at a certain temperature. This overall accuracy assumes that the unloaded and loaded measurements were taken at the same temperature. Drift error over temperature is not compensated and varies with each transducer. For best results, take a reference reading or execute the bias function at the current temperature before applying the load of interest.

Table 4.1—Error Introduced Over Temperature for Non-Gamma Transducers	
Deviation from 22°C	Typical Gain Error
± 5°C	0.1%
± 15°C	0.5%
± 25°C ¹	1%
± 50°C ¹	5%

Note:

1. Deviation is bounded by transducer operational limits in [Section 4.3—Environmental](#).

Table 4.2—Error Introduced Over Temperature for Gamma Transducers	
Deviation from 22°C	Typical Gain Error
± 5°C	0.1%
± 15°C	0.5%
± 25°C ¹	1.5%
± 50°C ¹	7%

Note:

1. Deviation is bounded by transducer operational limits in [Section 4.3—Environmental](#).

4.2 Tool Transformation Effects

All transducer working specifications pertain to the factory point-of-origin only. This includes the transducer's range, resolution, and accuracy. The transducer working specifications at a customer-applied point-of-origin differ from those at the factory point-of-origin.

4.3 Environmental

The F/T system is designed to be used in standard laboratory or light-manufacturing conditions. Transducers with an IP60 designation are able to withstand dusty environments, those with an IP65 designation are able to withstand dusty environments and wash down, and those with an IP68 designation are able to withstand dusty environments and fresh-water immersion to a specified depth. Transducers without IP65 or IP68 designation may be used in environments with up to 95% relative humidity, non-condensing.

Table 4.3—Transducer Temperature Ranges			
Transducer Model Series	Storage	Operation	Unit
9105-TIF Transducer	-25 to +80	0 to +60	°C
9105-TW Transducer	-25 to +80	0 to +80	
9105-TW-MINI/NANO Transducer	-40 to +100	0 to +100	
9105-T Transducer	-20 to 80	0 to +70	
9105-TWE Transducer	-25 to 85	0 to +85	
9105-NET Transducer	0 to +85	0 to +85	
9105-ECAT Transducer	0 to +70	0 to +70	
Note: 1. These temperature ranges specify the storage and operation ranges in which the transducer can survive without damage. They do not take accuracy into account.			

4.4 Mux Transducer Input Filter Frequency Response

NOTICE: Mux transducers are only used in 9105-CTL, 9105-CON, and 9105-CTE systems.

The input filter used in 9105-T transducers and in the Mux box is used to prevent aliasing. This filtering is not used in 9105-TIF (DAQ) or a TWE transducers.

Figure 4.1—Mux input filter frequency response (-3dB @ 235Hz)

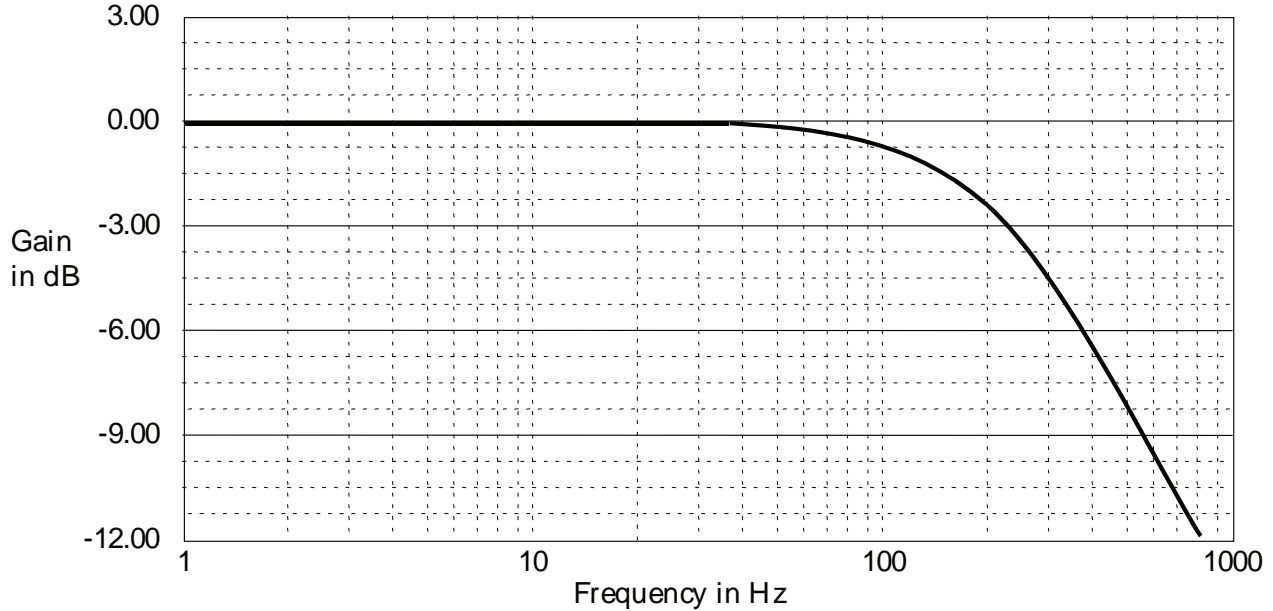

4.5 Transducer Strain Gage Saturation

The F/T sensor's strain gages are optimally placed to share information between the forces and torques applied to the sensor. Because of this sharing, it is possible to saturate the transducer with a complex load that has components below the rated load of the sensor. However, this arrangement allows a greater sensing range and resolution.



CAUTION: When any strain gage is saturated or otherwise inoperable, **all transducer F/T readings are invalid.** It is vitally important to monitor for these conditions.

5. Transducer Specifications

5.1 Notes on the Specification Section

5.1.1 ATI Website

All transducer specifications and additional information are also available on the ATI website:
https://www.ati-ia.com/products/ft/ft_ModelListing.aspx.

5.1.2 About CTL Calibration Specifications

CTL refers to F/T systems that use the F/T Controller. Transducers used in these systems either have a 9105-T-x model transducer or include a Mux Box. The output resolution of CTL systems is different from other systems. CTL systems also provide analog voltage outputs that represent each of the six axes. CTL transducers have their own calibration specification listings because of these differences.

5.1.3 Complex Loading Graph Description

The graphs in the sections for each transducer may be used to estimate a sensor's range under complex loading. Each page represents one sensor body with either English or Metric units. The top graph represents combinations of forces in the X and/or Y directions with torques about the Z-axis. The bottom graph represents combinations of Z-axis forces with X- and/or Y-axis torques. The graphs contain several different calibrations, distinguished by line weight.

The sample graph shown in *Figure 5.1* shows how operating ranges can change with complex loading. The regions are indicated by the following labels:

- A. Normal operating region. You can expect to achieve rated accuracy in this region.
- B. Saturation region. Any load in this region will report a gage saturation condition.
- C. Extended operating region. In this region, the sensor will operate correctly but the full-scale accuracy is not guaranteed.

Figure 5.1—Complex Loading Sample Graph

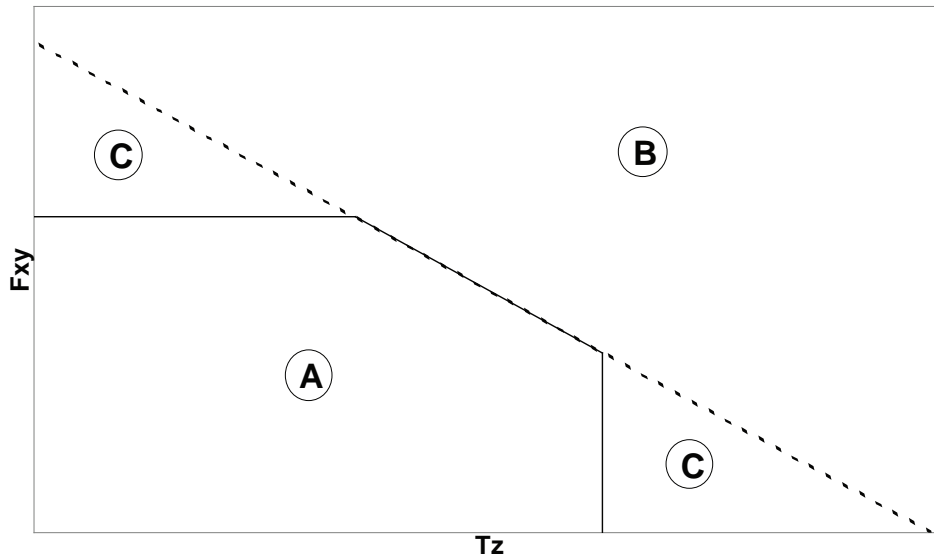

5.2 Nano17 Titanium

In addition to the information in the following sections, refer to the ATI website:

Table 5.1—Nano17 Titanium Drawing and Web Links		
Model	Drawing Part Number	ATI Website Address
Nano17 Titanium	9230-05-1336	https://www.ati-ia.com/products/ft/ft_models.aspx?id=Nano17+Titanium

5.2.1 Nano17 Titanium Physical Properties

Table 5.2—Nano17 Titanium Physical Properties		
Single-Axis Overload	(US) Standard Units	(SI) Metric Units
Fxy	±35 lbf	±160 N
Fz	±70 lbf	±310 N
Txy	±8.9 inf-lb	±1 Nm
Tz	±10 inf-lb	±1.2 Nm
Stiffness (Calculated)		
X-axis & Y-axis forces (Kx, Ky)	2.7x10 ⁴ lb/in	4.8x10 ⁶ N/m
Z-axis force (Kz)	3.8x10 ⁴ lb/in	6.6x10 ⁶ N/m
X-axis & Y-axis torque (Ktx, Kty)	1.2x10 ³ lbf-in/rad	1.4x10 ² Nm/rad
Z-axis torque (Ktz)	2.0x10 ³ lbf-in/rad	2.2x10 ² Nm/rad
Resonant Frequency		
Fx, Fy, Tz	3000 Hz	3000 Hz
Fz, Tx, Ty	3000 Hz	3000 Hz
Physical Specifications		
Weight ¹	0.0223 lb	0.0101 kg
Diameter ¹	0.669 in	17 mm
Height ¹	0.571 in	14.5 mm
Note: 1. Specifications include standard interface plates.		

5.2.2 Calibration Specifications (excludes CTL calibrations)

Table 5.3— Nano17 Titanium Calibrations (excludes CTL calibrations) ^{1, 2}									
Sensor	(US) Standard Calibration	Fx,Fy (lbf)	Fz (lbf)	Tx,Ty (lbf-in)	Tz (lbf-in)	Fx,Fy (lbf)	Fz (lbf)	Tx,Ty (lbf-in)	Tz (lbf-in)
Nano17 Titanium	US-1.8-0.4	1.8	3.15	0.4	0.4	1/3400	1/2720	7/92800	1/18560
Nano17 Titanium	US-3.6-0.8	3.6	6.3	0.8	0.8	1/1700	1/1360	7/46400	1/9280
Nano17 Titanium	US-7.2-1.6	7.2	12.6	1.6	1.6	1/850	1/680	7/23200	1/4640
Sensor	(SI) Metric Calibration	Fx,Fy (N)	Fz (N)	Tx,Ty (Nmm)	Tz (Nmm)	Fx,Fy (N)	Fz (N)	Tx,Ty (Nmm)	Tz (Nmm)
Nano17 Titanium	SI-8-0.05	8	14.1	50	50	1/682	1/682	3/364	5/728
Nano17 Titanium	SI-16-0.1	16	28.2	100	100	1/341	1/341	3/182	5/364
Nano17 Titanium	SI-32-0.2	32	56.4	200	200	1/171	1/171	3/92	5/184
		Sensing Ranges				Resolution (DAQ, Net F/T)³			

Notes:

1. These system resolutions quoted are the effective resolution after dropping eight counts of noise. The effective resolution can be improved with filtering.
2. Applied loads must be within range in each of the six axes for the F/T sensor to measure correctly.
3. DAQ resolutions are typical for a 16-bit data acquisition system.

5.2.3 CTL Calibration Specifications

Table 5.4— Nano17 Titanium CTL Calibrations ^{1, 2}									
Sensor	(US) Standard Calibration	Fx,Fy (lbf)	Fz (lbf)	Tx,Ty (lbf-in)	Tz (lbf-in)	Fx,Fy (lbf)	Fz (lbf)	Tx,Ty (lbf-in)	Tz (lbf-in)
Nano17 Titanium	US-1.8-0.4	1.8	3.15	0.4	0.4	1/1700	1/1360	7/46400	1/9280
Nano17 Titanium	US-3.6-0.8	3.6	6.3	0.8	0.8	1/850	1/680	7/23200	1/4640
Nano17 Titanium	US-7.2-1.6	7.2	12.6	1.6	1.6	1/425	1/340	7/11600	1/2320
Sensor	(SI) Metric Calibration	Fx,Fy (N)	Fz (N)	Tx,Ty (Nmm)	Tz (Nmm)	Fx,Fy (N)	Fz (N)	Tx,Ty (Nmm)	Tz (Nmm)
Nano17 Titanium	SI-8-0.05	8	14.1	50	50	1/341	1/341	3/182	5/364
Nano17 Titanium	SI-16-0.1	16	28.2	100	100	2/341	2/341	3/91	5/182
Nano17 Titanium	SI-32-0.2	32	56.4	200	200	2/171	2/171	3/46	5/92
		Sensing Ranges				Resolution (Controller)			

Notes:

1. CTL resolutions are typical. System resolutions quoted are the effective resolution after dropping eight counts of noise. The effective resolution can be improved with filtering.
2. Applied loads must be within range in each of the six axes for the F/T sensor to measure correctly.

5.2.4 CTL Analog Output

Table 5.5— Nano17 Titanium Analog Output							
Sensor	(US) Standard Calibration	Fx,Fy (lbf)	Fz (lbf)	Tx,Ty,Tz (lbf-in)	Fx,Fy (lbf/V)	Fz (lbf/V)	Tx,Ty,Tz (lbf-in/V)
Nano17 Titanium	US-1.8-0.4	±1.8	±3.15	±0.4	0.18	0.315	0.04
Nano17 Titanium	US-3.6-0.8	±3.6	±6.3	±0.8	0.36	0.63	0.08
Nano17 Titanium	US-7.2-1.6	±7.2	±12.6	±1.6	0.72	1.26	0.16
Sensor	(SI) Metric Calibration	Fx,Fy (N)	Fz (N)	Tx,Ty,Tz (Nmm)	Fx,Fy (N/V)	Fz (N/V)	Tx,Ty,Tz (Nmm/V)
Nano17 Titanium	SI-8-0.05	±8	±14.1	±50	0.8	1.41	5
Nano17 Titanium	SI-16-0.1	±16	±28.2	±100	1.6	2.82	10
Nano17 Titanium	SI-32-0.2	±32	±56.4	±200	3.2	5.64	20
		Analog Output Range			Analog ±10V Sensitivity¹		
Notes:							
1. ±5V Sensitivity values are double the listed ±10V Sensitivity values.							

5.2.5 CTL Counts Value

Table 5.6—Counts Value					
Sensor	Calibration	Fx, Fy, Fz (/ lbf)	Tx, Ty, Tz (/ lbf-in)	Fx, Fy, Fz (/ N)	Tx, Ty, Tz (/ Nmm)
Nano17 Titanium	US-1.8–0.4 / SI-8–0.05	54400	371200	1280	256
Nano17 Titanium	US-3.6–0.8 / SI-16–0.1	27200	185600	640	128
Nano17 Titanium	US-7.2–1.6 / SI-32–0.2	13600	82800	320	64
Nano17 Titanium	Tool Transform Factor	0.0022 in/lbf		0.0375 mm/N	
		Counts Value – Standard (US)		Counts Value – Metric (SI)	

5.2.6 Nano17 Titanium (US Calibration Complex Loading)

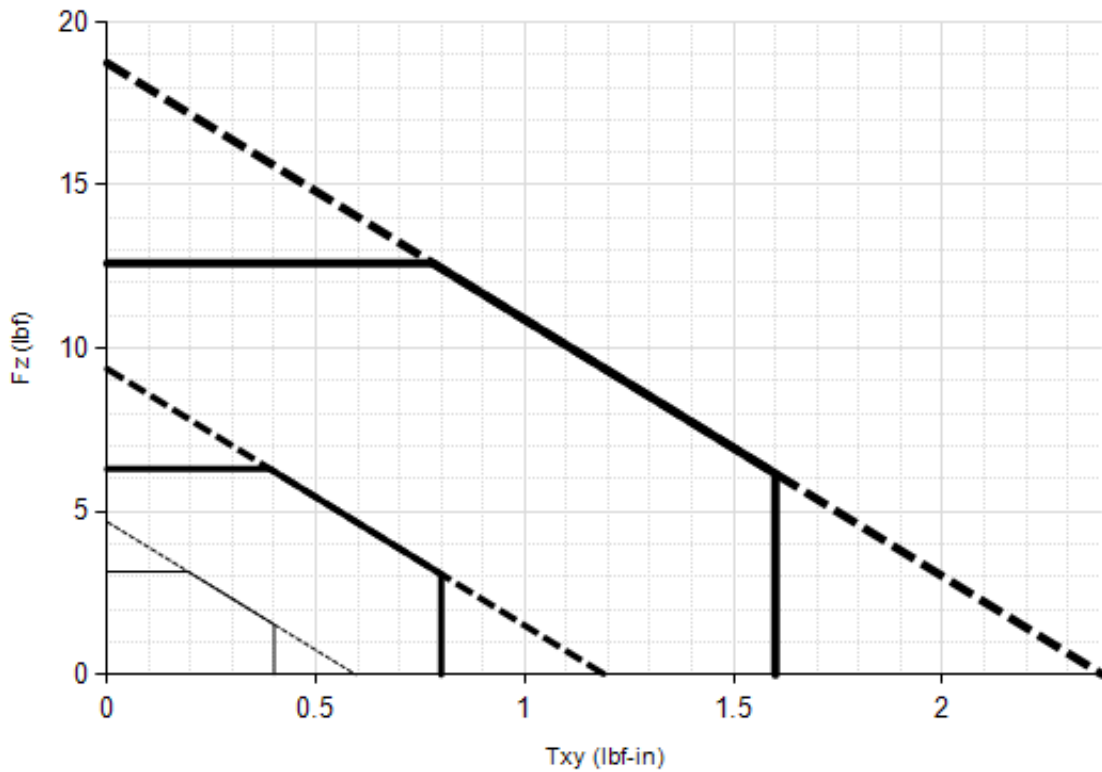
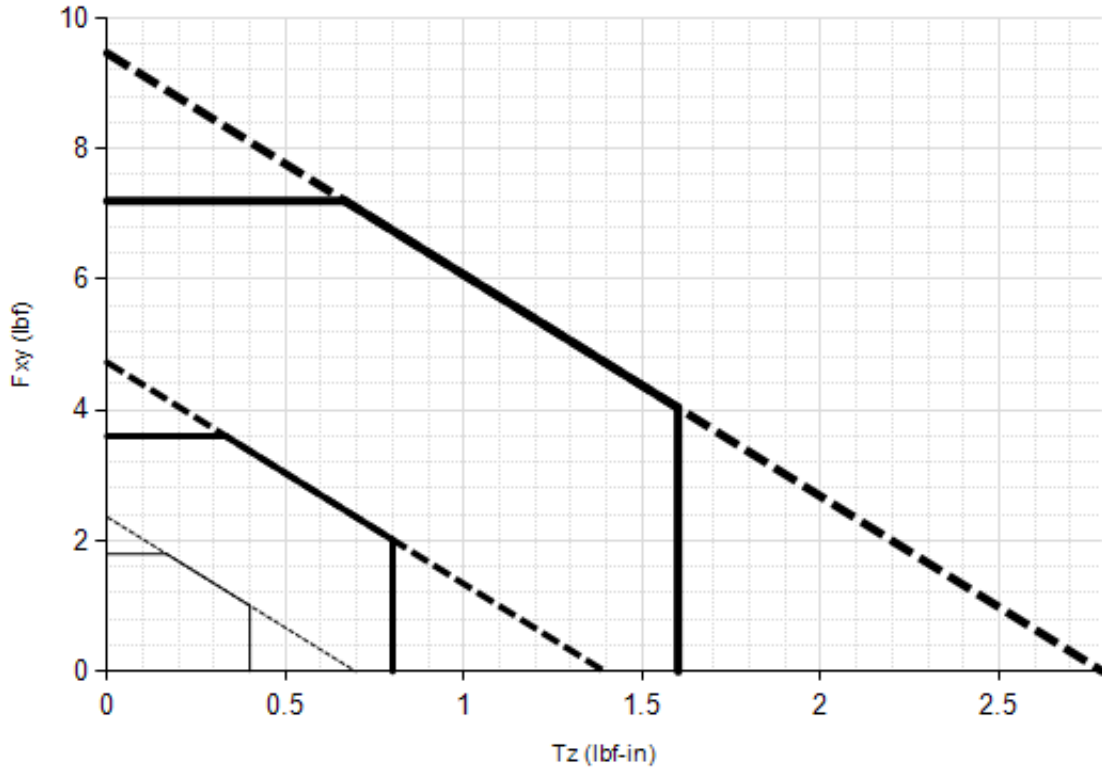

US-1.8-0.4
 US-3.6-0.8
 US-7.2-1.6

5.2.7 Nano17 Titanium (SI Calibration Complex Loading)

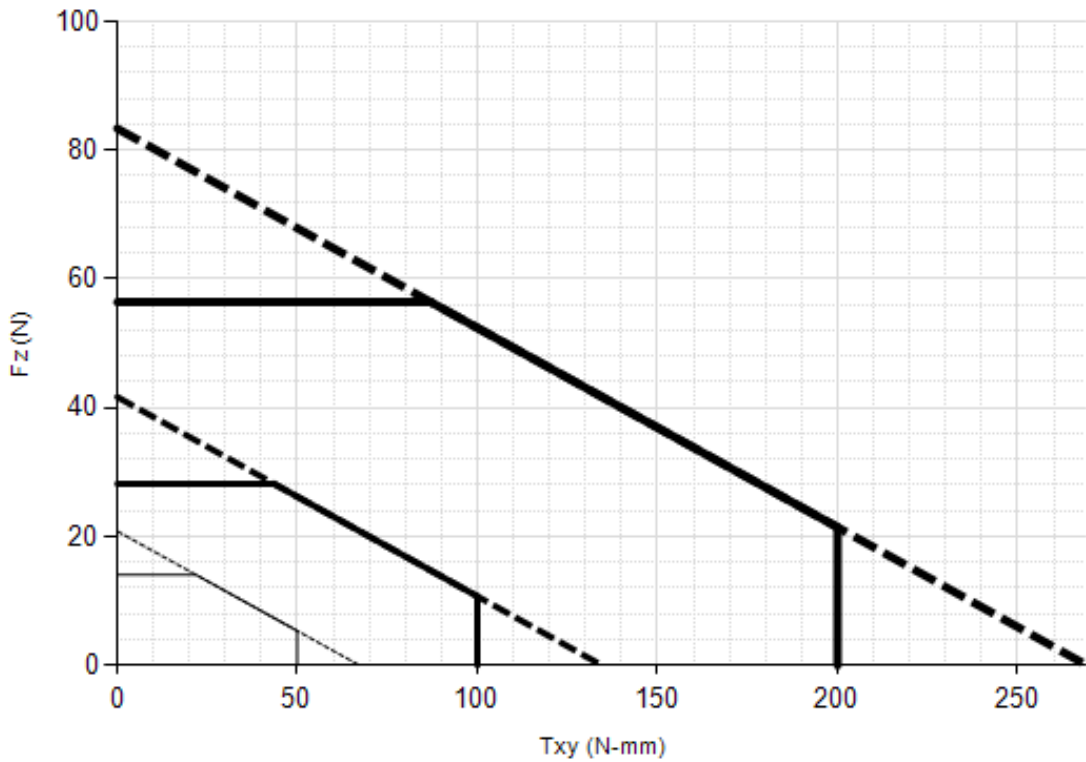
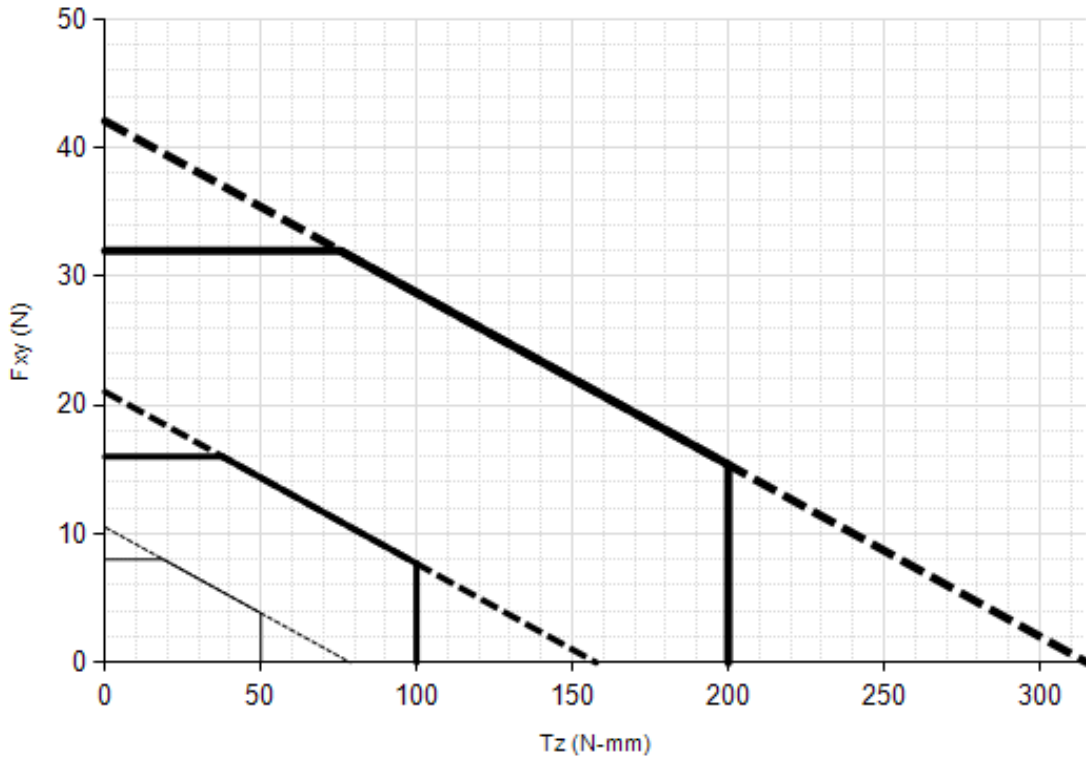

SI-8-0.05
 SI-16-0.1
 SI-32-0.2

5.3 Nano17 Specifications (Includes IP65/IP68 Versions)

In addition to the information in the following sections, refer to the ATI website:

Model	Drawing Part Number	ATI Website Address
Nano17	9230-05-1073	https://www.ati-ia.com/products/ft/ft_models.aspx?id=Nano17
Nano17-E	9230-05-1311	
Nano17 IP65/IP68	9230-05-1364	https://www.ati-ia.com/products/ft/ft_models.aspx?id=Nano17+IP65%2fIP68

5.3.1 Nano17 Physical Properties

Single-Axis Overload	(US) Standard Units	(SI) Metric Units
Fxy	±56 lbf	±250 N
Fz	±110 lbf	±480 N
Txy	±14 inf-lb	±1.6 Nm
Tz	±16 inf-lb	±1.8 Nm
Stiffness (Calculated)		
X-axis & Y-axis forces (Kx, Ky)	4.7x10 ⁴ lb/in	8.2x10 ⁶ N/m
Z-axis force (Kz)	6.5x10 ⁴ lb/in	1.1x10 ⁷ N/m
X-axis & Y-axis torque (Ktx, Kty)	2.1x10 ³ lbf-in/rad	2.4x10 ² Nm/rad
Z-axis torque (Ktz)	3.4x10 ³ lbf-in/rad	3.8x10 ² Nm/rad
Resonant Frequency		
Fx, Fy, Tz	7200 Hz	7200 Hz
Fz, Tx, Ty	7200 Hz	7200 Hz
Physical Specifications		
Weight ¹	0.02 lb	0.00907 kg
Diameter ¹	0.669 in	17 mm
Height ¹	0.571 in	14.5 mm
Note: 1. Specifications include standard interface plates.		

5.3.2 Nano17 IP65/IP68 Physical Properties

Table 5.9—Nano17 IP65/IP68 Physical Properties		
Single-Axis Overload	(US) Standard Units	(SI) Metric Units
Fxy	±56 lbf	±250 N
Fz	±110 lbf	±480 N
Txy	±14 inf-lb	±1.6 Nm
Tz	±16 inf-lb	±1.8 Nm
Stiffness (Calculated)		
X-axis & Y-axis forces (Kx, Ky)	4.7x10 ⁴ lb/in	8.2x10 ⁶ N/m
Z-axis force (Kz)	6.5x10 ⁴ lb/in	1.1x10 ⁷ N/m
X-axis & Y-axis torque (Ktx, Kty)	2.1x10 ³ lbf-in/rad	2.4x10 ² Nm/rad
Z-axis torque (Ktz)	3.4x10 ³ lbf-in/rad	3.8x10 ² Nm/rad
Resonant Frequency		
Fx, Fy, Tz	2200 Hz	2200 Hz
Fz, Tx, Ty	2200 Hz	2200 Hz
Physical Specifications		
Weight ¹	0.09 lb	0.0408 kg
Diameter ¹	0.79 in	20.1 mm
Height ¹	0.873 in	22.2 mm
Note: 1. Specifications include standard interface plates.		



CAUTION: When submerged, IP68 transducers exhibit a decrease in Fz range related to the submersion depth. This loss is the result of pressure-induced preloading on the transducer. The preload can be masked by biasing the transducer at the depth prior to applying the load to be measured. The following estimates are for room temperature fresh water at sea level.

	Submersion Depth	
IP68 Nano17	US	Metric
Fz preload at 4 m depth	2.01 lb	8.93 N
Fz preload at other depths	-0.15 lb/ft × depth In Feet	-2.23 N/m × depth In Meters

5.3.3 Calibration Specifications (excludes CTL calibrations)

Table 5.10— Nano17 Calibrations (excludes CTL calibrations)1, 2									
Sensor	(US) Standard Calibration	Fx,Fy (lbf)	Fz ³ (lbf)	Tx,Ty (lbf-in)	Tz (lbf-in)	Fx,Fy (lbf)	Fz ³ (lbf)	Tx,Ty (lbf-in)	Tz (lbf-in)
Nano17	US-3-1	3	4.25	1	1	1/1280	1/1280	1/8000	1/8000
Nano17	US-6-2	6	8.5	2	2	1/640	1/640	1/4000	1/4000
Nano17	US-12-4	12	17	4	4	1/320	1/320	1/2000	1/2000
Sensor	(SI) Metric Calibration	Fx,Fy (N)	Fz ³ (N)	Tx,Ty (Nmm)	Tz (Nmm)	Fx,Fy (N)	Fz ³ (N)	Tx,Ty (Nmm)	Tz (Nmm)
Nano17	SI-12-0.12	12	17	120	120	1/320	1/320	1/64	1/64
Nano17	SI-25-0.25	25	35	250	250	1/160	1/160	1/32	1/32
Nano17	SI-50-0.5	50	70	500	500	1/80	1/80	1/16	1/16
Sensing Ranges						Resolution (DAQ, Net F/T)⁴			

Notes:

1. These system resolutions quoted are the effective resolution after dropping eight counts of noise. The effective resolution can be improved with filtering.
2. Applied loads must be within range in each of the six axes for the F/T sensor to measure correctly.
3. For IP68 version see caution on physical properties page.
4. DAQ resolutions are typical for a 16-bit data acquisition system.

5.3.4 CTL Calibration Specifications

Table 5.11— Nano17 CTL Calibrations1, 2									
Sensor	(US) Standard Calibration	Fx,Fy (lbf)	Fz ³ (lbf)	Tx,Ty (lbf-in)	Tz (lbf-in)	Fx,Fy (lbf)	Fz ³ (lbf)	Tx,Ty (lbf-in)	Tz (lbf-in)
Nano17	US-3-1	3	4.25	1	1	1/640	1/640	1/4000	1/4000
Nano17	US-6-2	6	8.5	2	2	1/320	1/320	1/2000	1/2000
Nano17	US-12-4	12	17	4	4	1/160	1/160	1/1000	1/1000
Sensor	(SI) Metric Calibration	Fx,Fy (N)	Fz ³ (N)	Tx,Ty (Nmm)	Tz (Nmm)	Fx,Fy (N)	Fz ³ (N)	Tx,Ty (Nmm)	Tz (Nmm)
Nano17	SI-12-0.12	12	17	120	120	1/160	1/160	1/32	1/32
Nano17	SI-25-0.25	25	35	250	250	1/80	1/80	1/16	1/16
Nano17	SI-50-0.5	50	70	500	500	1/40	1/40	1/8	1/8
Sensing Ranges						Resolution (Controller)			

Notes:

1. CTL resolutions are typical. System resolutions quoted are the effective resolution after dropping eight counts of noise. The effective resolution can be improved with filtering.
2. Applied loads must be within range in each of the six axes for the F/T sensor to measure correctly.
3. For IP68 version see caution on physical properties page.

5.3.5 CTL Analog Output

Table 5.12— Nano17 Analog Output							
Sensor	(US) Standard Calibration	Fx,Fy (lbf)	Fz ² (lbf)	Tx,Ty,Tz (lbf-in)	Fx,Fy (lbf/V)	Fz ² (lbf/V)	Tx,Ty,Tz (lbf-in/V)
Nano17	US-3-1	±3	±4.25	±1	0.3	0.425	0.1
Nano17	US-6-2	±6	±8.5	±2	0.6	0.85	0.2
Nano17	US-12-4	±12	±17	±4	1.2	1.7	0.4
Sensor	(SI) Metric Calibration	Fx,Fy (N)	Fz ² (N)	Tx,Ty,Tz (Nmm)	Fx,Fy (N/V)	Fz ² (N/V)	Tx,Ty,Tz (Nmm/V)
Nano17	SI-12-0.12	±12	±17	±120	1.2	1.7	12
Nano17	SI-25-0.25	±25	±35	±250	2.5	3.5	25
Nano17	SI-50-0.5	±50	±70	±500	5	7	50
		Analog Output Range			Analog ±10V Sensitivity¹		

Notes:
 1. ±5V Sensitivity values are double the listed ±10V Sensitivity values.
 2. For IP68 version see caution on physical properties page.

5.3.6 CTL Counts Value

Table 5.13—Counts Value					
Sensor	Calibration	Fx, Fy, Fz (/ lbf)	Tx, Ty, Tz (/ lbf-in)	Fx, Fy, Fz (/ N)	Tx, Ty, Tz (/ Nmm)
Nano17	US-3-1 / SI-12-0.25	5120	32000	1280	256
Nano17	US-6-2 / SI-25-0.25	2560	16000	640	128
Nano17	US-12-4 / SI-50-0.5	1280	8000	320	64
Nano17	Tool Transform Factor	0.0016 in/lbf		0.05 mm/N	
		Counts Value – Standard (US)		Counts Value – Metric (SI)	

5.3.7 Nano17 (US Calibration Complex Loading)(Includes IP65/IP68)¹

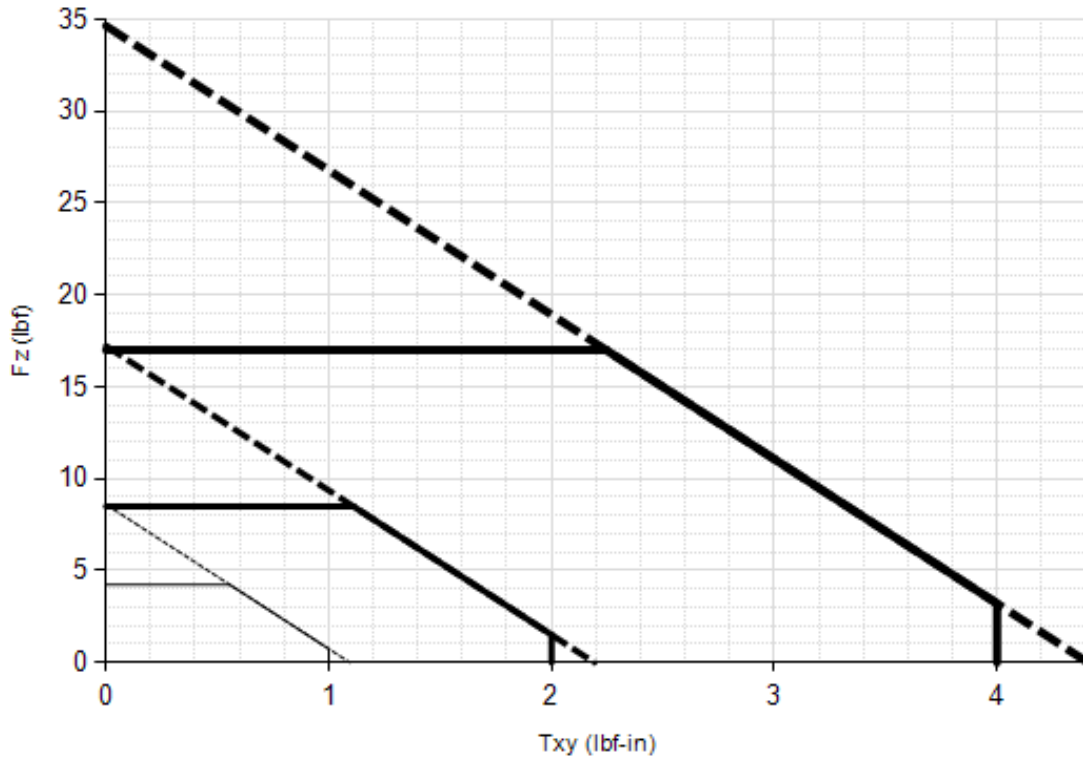
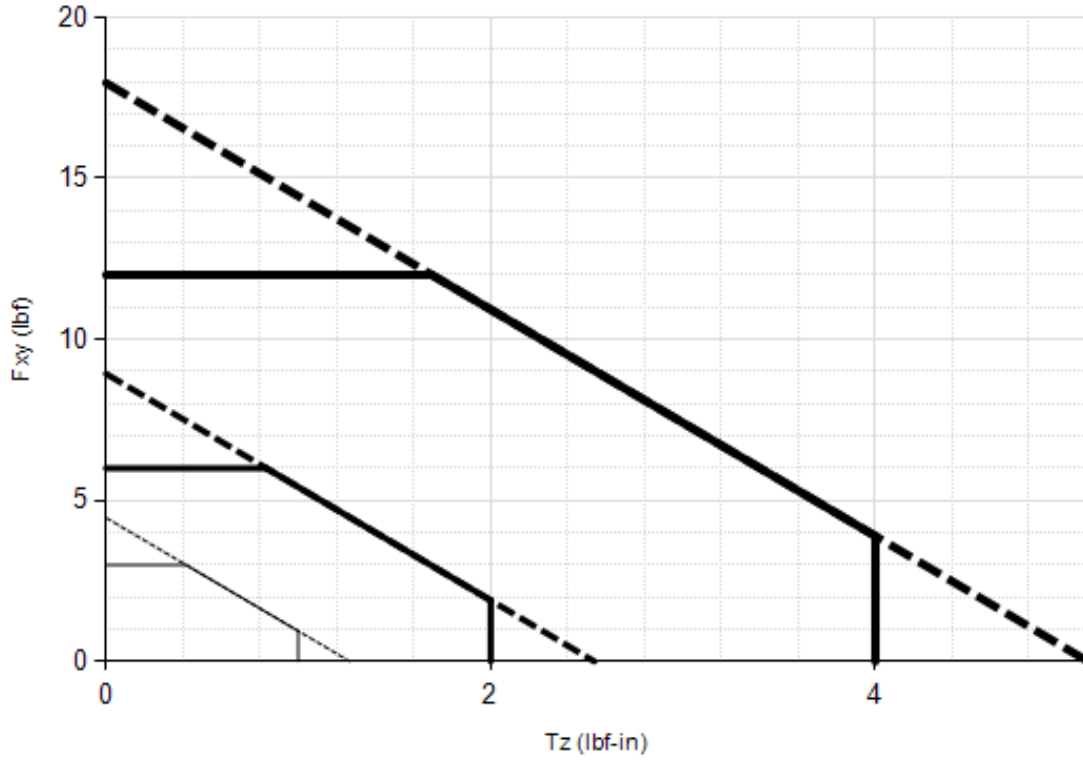

US-3-1
 US-6-2
 US-12-4

Note: 1. For IP68 version see caution on physical properties page.

5.3.8 Nano17 (SI Calibration Complex Loading)(Includes IP65/IP68)¹

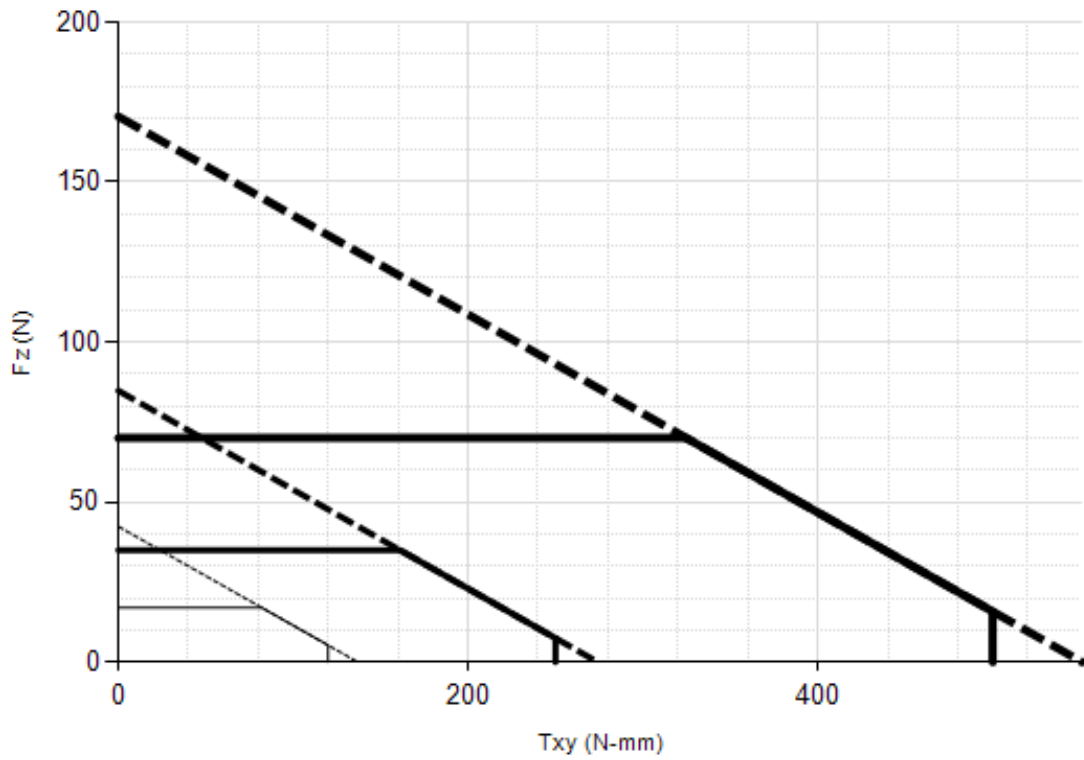
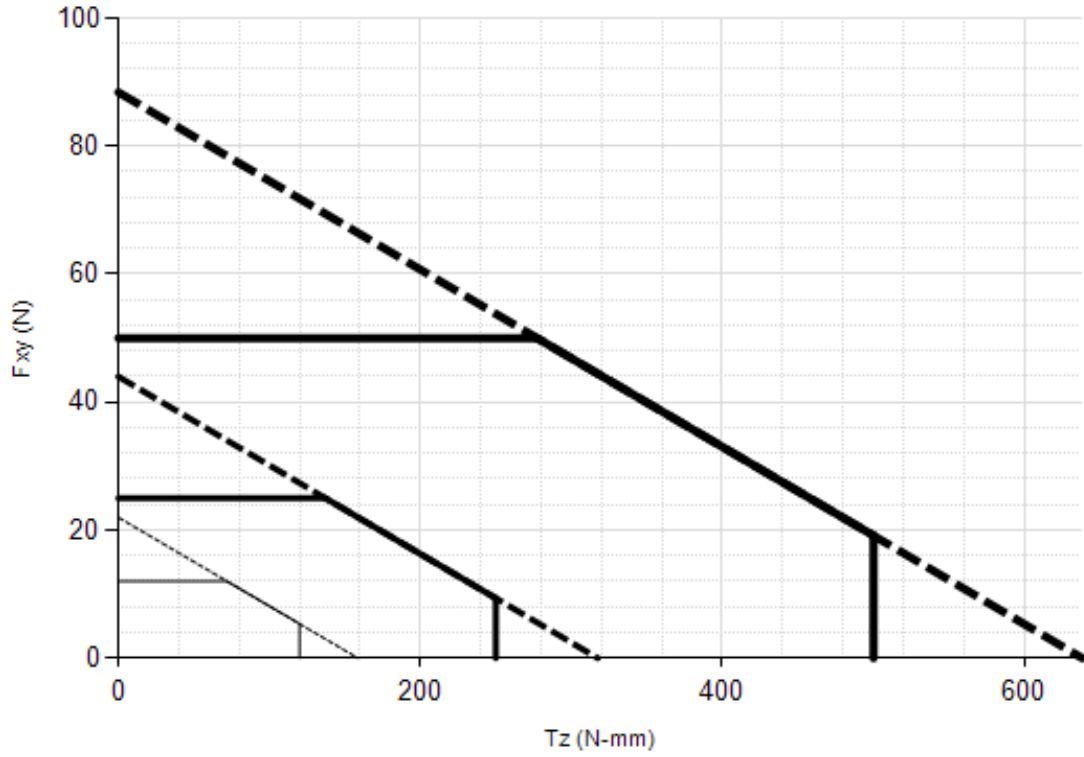

SI-12-0.12
 SI-25-0.25
 SI-50-0.5

Note: 1. For IP68 version see caution on physical properties page.

5.4 Nano25 Specifications (Includes IP65/IP68 Versions)

In addition to the information in the following sections, refer to the ATI website:

Table 5.14—Nano25 Drawing and Web Links		
Model	Drawing Part Number	ATI Website Address
Nano25	9230-05-1083	https://www.ati-ia.com/products/ft/ft_models.aspx?id=Nano25
Nano25-E	9230-05-1312	
Nano25 IP65/ IP68 (Axial Cable Exit)	9230-05-1259	https://www.ati-ia.com/products/ft/ft_models.aspx?id=Nano25+IP65%2fIP68
Nano25 IP65/ IP68 (Radial Cable Exit)	9230-05-1337	

5.4.1 Nano25 Physical Properties

Table 5.15—Nano25 Physical Properties		
Single-Axis Overload	(US) Standard Units	(SI) Metric Units
Fxy	±520 lbf	±2300 N
Fz	±1600 lbf	±7300 N
Txy	±380 inf-lb	±43 Nm
Tz	±560 inf-lb	±63 Nm
Stiffness (Calculated)		
X-axis & Y-axis forces (Kx, Ky)	3.0x10 ⁵ lb/in	5.3x10 ⁷ N/m
Z-axis force (Kz)	6.3x10 ⁵ lb/in	1.1x10 ⁸ N/m
X-axis & Y-axis torque (Ktx, Kty)	5.7x10 ⁴ lbf-in/rad	6.5x10 ³ Nm/rad
Z-axis torque (Ktz)	8.1x10 ⁴ lbf-in/rad	9.2x10 ³ Nm/rad
Resonant Frequency		
Fx, Fy, Tz	3600 Hz	3600 Hz
Fz, Tx, Ty	3800 Hz	3800 Hz
Physical Specifications		
Weight ¹	0.14 lb	0.0634 kg
Diameter ¹	0.984 in	25 mm
Height ¹	0.85 in	21.6 mm
Note: 1. Specifications include standard interface plates.		

5.4.2 Nano25 IP65/IP68 Physical Properties

Table 5.16—Nano25 IP65/IP68 Physical Properties		
Single-Axis Overload	(US) Standard Units	(SI) Metric Units
Fxy	±520 lbf	±2300 N
Fz	±1600 lbf	±7300 N
Txy	±380 inf-lb	±43 Nm
Tz	±560 inf-lb	±63 Nm
Stiffness (Calculated)		
X-axis & Y-axis forces (Kx, Ky)	3.0x10 ⁵ lb/in	5.3x10 ⁷ N/m
Z-axis force (Kz)	6.3x10 ⁵ lb/in	1.1x10 ⁸ N/m
X-axis & Y-axis torque (Ktx, Kty)	5.7x10 ⁴ lbf-in/rad	6.5x10 ³ Nm/rad
Z-axis torque (Ktz)	8.1x10 ⁴ lbf-in/rad	9.2x10 ³ Nm/rad
Resonant Frequency		
Fx, Fy, Tz	3400 Hz	3400 Hz
Fz, Tx, Ty	3500 Hz	3500 Hz
Physical Specifications		
Weight ¹	0.3 lb	0.136 kg
Diameter ¹	1.1 in	28 mm
Height ¹	1.08 in	27.5 mm
Note: 1. Specifications include standard interface plates.		



CAUTION: When submerged, IP68 transducers exhibit a decrease in Fz range related to the submersion depth. This loss is the result of pressure-induced preloading on the transducer. The preload can be masked by biasing the transducer at the depth prior to applying the load to be measured. The following estimates are for room temperature fresh water at sea level.

Submersion Depth		
IP68 Nano17	US	Metric
Fz preload at 4 m depth	4.33 lb	19.3 N
Fz preload at other depths	-0.33 lb/ft × depthInFeet	-4.81 N/m × depthInMeters

NOTICE: The outer body of the IP65 and the IP68 versions of the Nano25 are electrically floating from the rest of the system. If the transducer signal has additional noise, it may be necessary to electrically connect the transducer body to the case of the F/T system.

5.4.3 Calibration Specifications (excludes CTL calibrations)

Table 5.17— Nano25 Calibrations (excludes CTL calibrations) ^{1, 2, 4}										
Sensor	(US) Standard Calibration	Fx,Fy (lbf)	Fz ³ (lbf)	Tx,Ty (lbf-in)	Tz (lbf-in)	Fx,Fy (lbf)	Fz ³ (lbf)	Tx,Ty (lbf-in)	Tz (lbf-in)	
Nano25	US-25-25	25	100	25	25	1/224	3/224	1/160	1/320	
Nano25	US-50-50	50	200	50	30	1/112	3/112	1/80	1/160	
Sensor	(SI) Metric Calibration	Fx,Fy (N)	Fz ³ (N)	Tx,Ty (Nm)	Tz (Nm)	Fx,Fy (N)	Fz ³ (N)	Tx,Ty (Nm)	Tz (Nm)	
Nano25	SI-125-3	125	500	3	3	1/48	1/16	1/1320	1/2640	
Nano25	SI-250-6	250	1000	6	3.4	1/24	1/8	1/660	1/1320	
					Sensing Ranges	Resolution (DAQ, Net F/T) ⁵				

Notes:

1. These system resolutions quoted are the effective resolution after dropping four counts of noise. The effective resolution can be improved with filtering.
2. Applied loads must be within range in each of the six axes for the F/T sensor to measure correctly.
3. For IP68 version see caution on physical properties page.
4. Applying moments beyond ± 30 lbf-in (± 3.4 Nm) in Tz can cause hysteresis and permanent zero-point change in the Nano25 (applies to all versions of the Nano25).
5. DAQ resolutions are typical for a 16-bit data acquisition system.

5.4.4 CTL Calibration Specifications

Table 5.18— Nano25 CTL Calibrations ^{1, 2, 4}										
Sensor	(US) Standard Calibration	Fx,Fy (lbf)	Fz ³ (lbf)	Tx,Ty (lbf-in)	Tz (lbf-in)	Fx,Fy (lbf)	Fz ³ (lbf)	Tx,Ty (lbf-in)	Tz (lbf-in)	
Nano25	US-25-25	25	100	25	25	1/112	3/112	1/80	1/160	
Nano25	US-50-50	50	200	50	30	1/56	3/56	1/40	1/80	
Sensor	(SI) Metric Calibration	Fx,Fy (N)	Fz ³ (N)	Tx,Ty (Nm)	Tz (Nm)	Fx,Fy (N)	Fz ³ (N)	Tx,Ty (Nm)	Tz (Nm)	
Nano25	SI-125-3	125	500	3	3	1/24	1/8	1/660	1/1320	
Nano25	SI-250-6	250	1000	6	3.4	1/12	1/4	1/330	1/660	
					Sensing Ranges	Resolution (Controller)				

Notes:

1. CTL resolutions are typical. System resolutions quoted are the effective resolution after dropping eight counts of noise. The effective resolution can be improved with filtering.
2. Applied loads must be within range in each of the six axes for the F/T sensor to measure correctly.
3. For IP68 version see caution on physical properties page.
4. Applying moments beyond ± 30 lbf-in (± 3.4 Nm) in Tz can cause hysteresis and permanent zero-point change in the Nano25 (applies to all versions of the Nano25).

5.4.5 CTL Analog Output

Table 5.19— Nano25 Analog Output							
Sensor	(US) Standard Calibration	Fx,Fy (lbf)	Fz ² (lbf)	Tx,Ty,Tz (lbf-in)	Fx,Fy (lbf/V)	Fz ² (lbf/V)	Tx,Ty,Tz (lbf-in/V)
Nano25	US-25-25	±25	±100	±25	2.5	10	2.5
Nano25	US-50-50	±50	±200	±50	5	20	5
Sensor	(SI) Metric Calibration	Fx,Fy (N)	Fz ² (N)	Tx,Ty,Tz (Nmm)	Fx,Fy (N/V)	Fz ² (N/V)	Tx,Ty,Tz (Nm/V)
Nano25	SI-125-3	±125	±500	±3	12.5	50	0.3
Nano25	SI-250-6	±250	±1000	±6	25	100	0.6
				Analog Output Range	Analog ±10V Sensitivity¹		
Notes:							
1. ±5V Sensitivity values are double the listed ±10V Sensitivity values.							
2. For IP68 version see caution on physical properties page.							

5.4.6 CTL Counts Value

Table 5.20—Counts Value					
Sensor	Calibration	Fx, Fy, Fz (/ lbf)	Tx, Ty, Tz (/ lbf-in)	Fx, Fy, Fz	Tx, Ty, Tz
Nano25	US-25-25 / SI-125-3	896	1280	192 / N	10560 / N
Nano25	US-50-50 / SI-250-6	448	640	96 / Nm	5280 / Nm
Nano25	Tool Transform Factor	0.007 in/lbf		0.18182 mm/N	
		Counts Value – Standard (US)		Counts Value – Metric (SI)	

5.4.7 Nano25 (US Calibration Complex Loading)(Includes IP65/IP68)¹

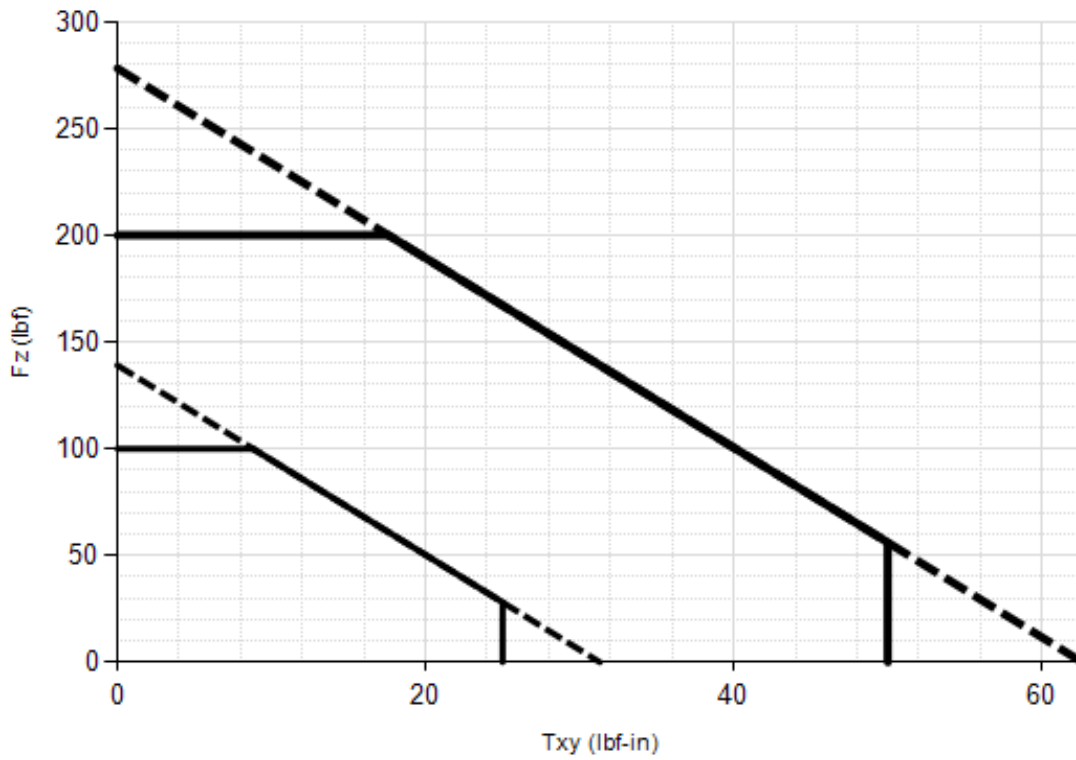
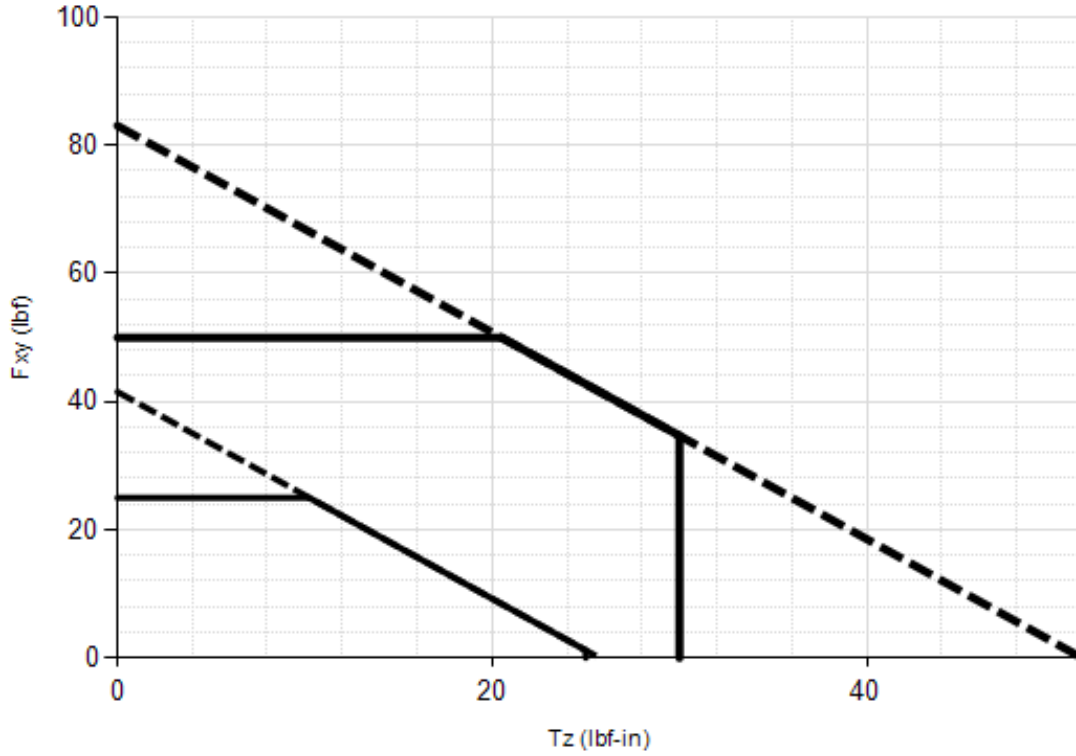

US-25-25
 US-50-50

Note: 1. For IP68 version see caution on physical properties page.

5.4.8 Nano25 (SI Calibration Complex Loading)(Includes IP65/IP68)¹

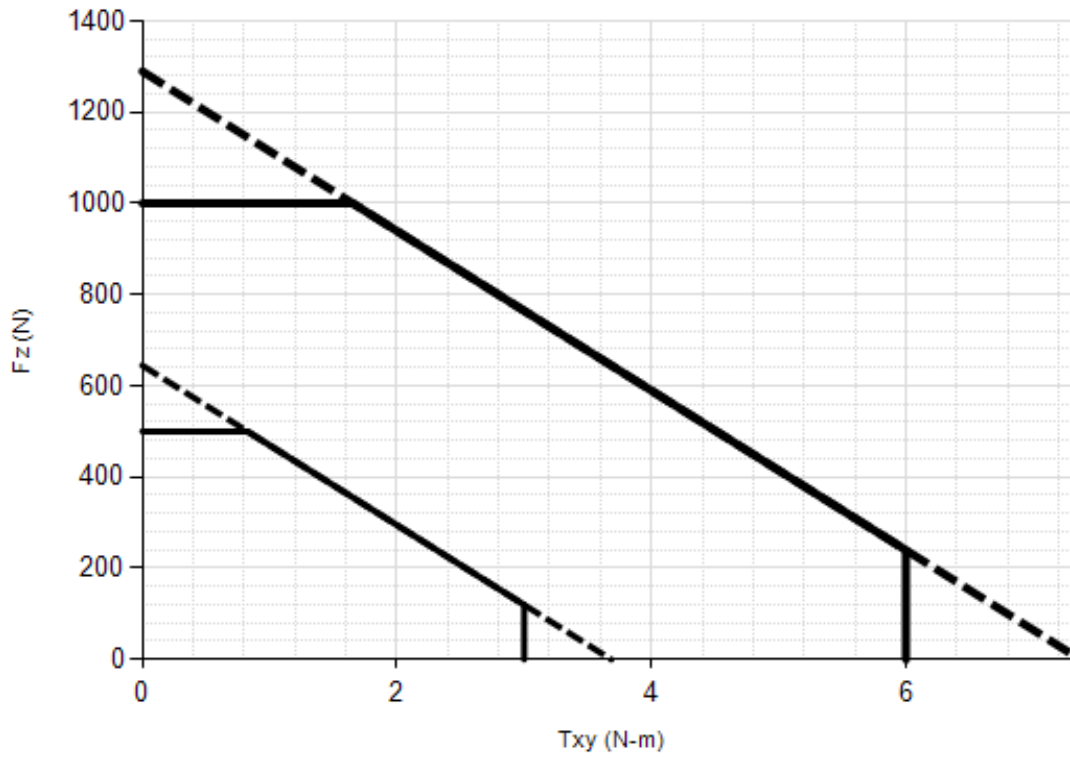

— SI-125-3 — SI-250-6

Note: 1. For IP68 version see caution on physical properties page.

5.5 Nano43 Specifications

In addition to the information in the following sections, refer to the ATI website:

Table 5.21—Nano43 Drawing and Web Links		
Model	Drawing Part Number	ATI Website Address
Nano25	9230-05-1110	https://www.ati-ia.com/products/ft/ft_models.aspx?id=Nano43

5.5.1 Nano43 Physical Properties

Table 5.22—Nano43 Physical Properties		
Single-Axis Overload	(US) Standard Units	(SI) Metric Units
Fxy	±68 lbf	±300 N
Fz	±86 lbf	±380 N
Txy	±29 inf-lb	±3.2 Nm
Tz	±41 inf-lb	±4.6 Nm
Stiffness (Calculated)		
X-axis & Y-axis forces (Kx, Ky)	2.9x10 ⁴ lb/in	5.2x10 ⁶ N/m
Z-axis force (Kz)	2.9x10 ⁴ lb/in	5.2x10 ⁶ N/m
X-axis & Y-axis torque (Ktx, Kty)	6.8x10 ³ lbf-in/rad	7.7x10 ² Nm/rad
Z-axis torque (Ktz)	1.0x10 ⁴ lbf-in/rad	1.1x10 ³ Nm/rad
Resonant Frequency		
Fx, Fy, Tz	2800 Hz	2800 Hz
Fz, Tx, Ty	2300 Hz	2300 Hz
Physical Specifications		
Weight ¹	0.0854 lb	0.0387 kg
Diameter ¹	1.69 in	43 mm
Height ¹	0.454 in	11.5 mm
Note: 1. Specifications include standard interface plates.		

NOTICE: The outer body of the Nano43 is electrically floating from the rest of the system. If the transducer signal has additional noise, it may be necessary to electrically connect the transducer body to the case of the F/T system.

5.5.2 Calibration Specifications (excludes CTL calibrations)

Table 5.23— Nano43 Calibrations (excludes CTL calibrations) ^{1, 2}										
Sensor	(US) Standard Calibration	Fx,Fy (lbf)	Fz (lbf)	Tx,Ty (lbf-in)	Tz (lbf-in)	Fx,Fy (lbf)	Fz (lbf)	Tx,Ty (lbf-in)	Tz (lbf-in)	
Nano43	US-2-1	2	2	1	1	1/2320	1/2320	1/4640	1/4640	
Nano43	US-4-2	4	4	2	2	1/1160	1/1160	1/2320	1/2320	
Nano43	US-8-4	8	8	4	4	1/580	1/580	1/1160	1/1160	
Sensor	(SI) Metric Calibration	Fx,Fy (N)	Fz (N)	Tx,Ty (Nmm)	Tz (Nmm)	Fx,Fy (N)	Fz (N)	Tx,Ty (Nmm)	Tz (Nmm)	
Nano43	SI-9-0.125	9	9	125	125	1/512	1/512	1/40	1/40	
Nano43	SI-18-0.25	18	18	250	250	1/256	1/256	1/20	1/20	
Nano43	SI-36-0.5	36	36	500	500	1/128	1/128	1/10	1/10	
					Sensing Ranges	Resolution (DAQ, Net F/T) ³				

Notes:

1. These system resolutions quoted are the effective resolution after dropping eight counts of noise. The effective resolution can be improved with filtering.
2. Applied loads must be within range in each of the six axes for the F/T sensor to measure correctly.
3. DAQ resolutions are typical for a 16-bit data acquisition system.

5.5.3 CTL Calibration Specifications

Table 5.24— Nano43 CTL Calibrations ^{1, 2}										
Sensor	(US) Standard Calibration	Fx,Fy (lbf)	Fz (lbf)	Tx,Ty (lbf-in)	Tz (lbf-in)	Fx,Fy (lbf)	Fz (lbf)	Tx,Ty (lbf-in)	Tz (lbf-in)	
Nano43	US-2-1	2	2	1	1	1/1160	1/1160	1/2320	1/2320	
Nano43	US-4-2	4	4	2	2	1/580	1/580	1/1160	1/1160	
Nano43	US-8-4	8	8	4	4	1/290	1/290	1/580	1/580	
Sensor	(SI) Metric Calibration	Fx,Fy (N)	Fz (N)	Tx,Ty (Nmm)	Tz (Nmm)	Fx,Fy (N)	Fz (N)	Tx,Ty (Nmm)	Tz (Nmm)	
Nano43	SI-9-0.125	9	9	125	125	1/256	1/256	1/20	1/20	
Nano43	SI-18-0.25	18	18	250	250	1/128	1/128	1/10	1/10	
Nano43	SI-36-0.5	36	36	500	500	1/64	1/64	1/5	1/5	
					Sensing Ranges	Resolution (Controller)				

Notes:

1. CTL resolutions are typical. System resolutions quoted are the effective resolution after dropping eight counts of noise. The effective resolution can be improved with filtering.
2. Applied loads must be within range in each of the six axes for the F/T sensor to measure correctly.

5.5.4 CTL Analog Output

Table 5.25— Nano43 Analog Output							
Sensor	(US) Standard Calibration	Fx,Fy (lbf)	Fz (lbf)	Tx,Ty,Tz (lbf-in)	Fx,Fy (lbf/V)	Fz (lbf/V)	Tx,Ty,Tz (lbf-in/V)
Nano43	US-2-1	N/A	N/A	N/A	N/A	N/A	N/A
Nano43	US-4-2	±4	±4	±2	0.4	0.4	0.2
Nano43	US-8-4	±8	±8	±4	0.8	0.8	0.4
Sensor	(SI) Metric Calibration	Fx,Fy (N)	Fz (N)	Tx,Ty,Tz (Nmm)	Fx,Fy (N/V)	Fz (N/V)	Tx,Ty,Tz (Nm/V)
Nano43	SI-9-0.125	N/A	N/A	N/A	N/A	N/A	N/A
Nano43	SI-18-0.25	±18	±18	±250	1.8	1.8	25
Nano43	SI-36-0.5	±36	±36	±500	3.6	3.6	50
		Analog Output Range			Analog ±10V Sensitivity¹		

Notes:
 1. ±5V Sensitivity values are double the listed ±10V Sensitivity values.

5.5.5 CTL Counts Value

Table 5.26—Counts Value					
Sensor	Calibration	Fx, Fy, Fz (/ lbf)	Tx, Ty, Tz (/ lbf-in)	Fx, Fy, Fz (/ N)	Tx, Ty, Tz (/ Nmm)
Nano43	US-2-1 / SI-9-0.125	N/A	N/A	N/A	N/A
Nano43	US-4-2 / SI-18-0.25	4640	9280	1024	80
Nano43	US-8-4 / SI-36-0.5	2320	4640	512	40
Nano43	Tool Transform Factor	0.005 in/lbf		0.128 mm/N	
		Counts Value – Standard (US)		Counts Value – Metric (SI)	

5.5.6 Nano43 (US Calibration Complex Loading)

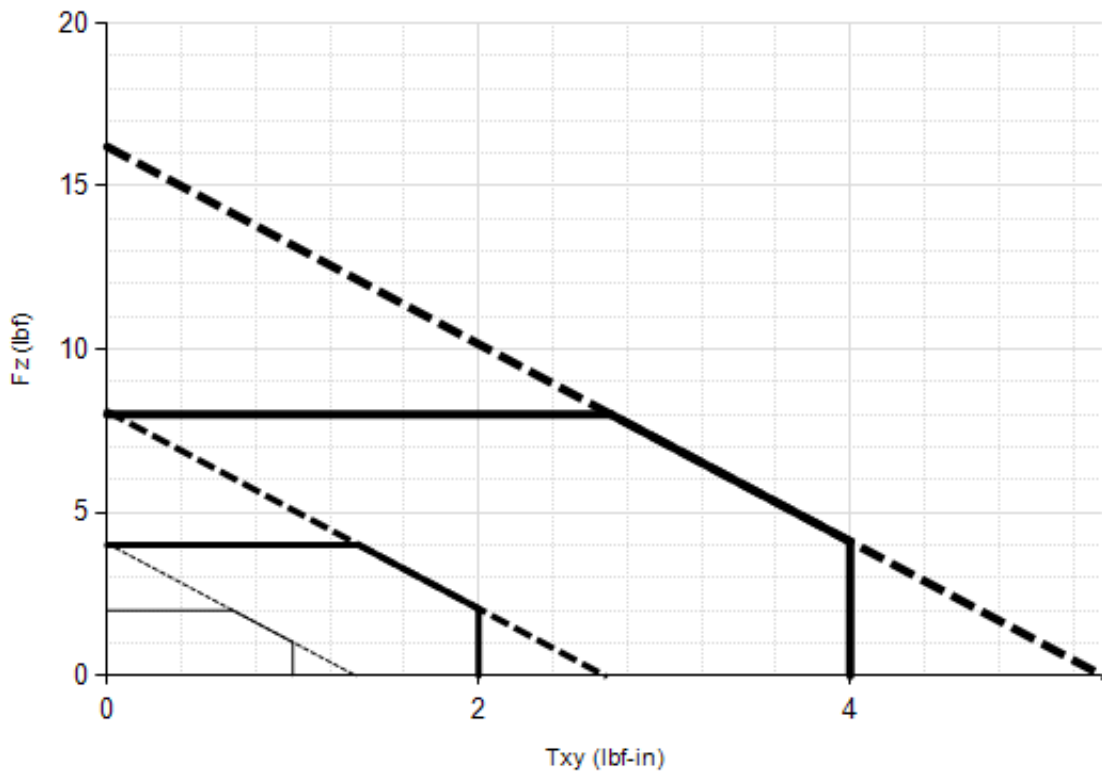
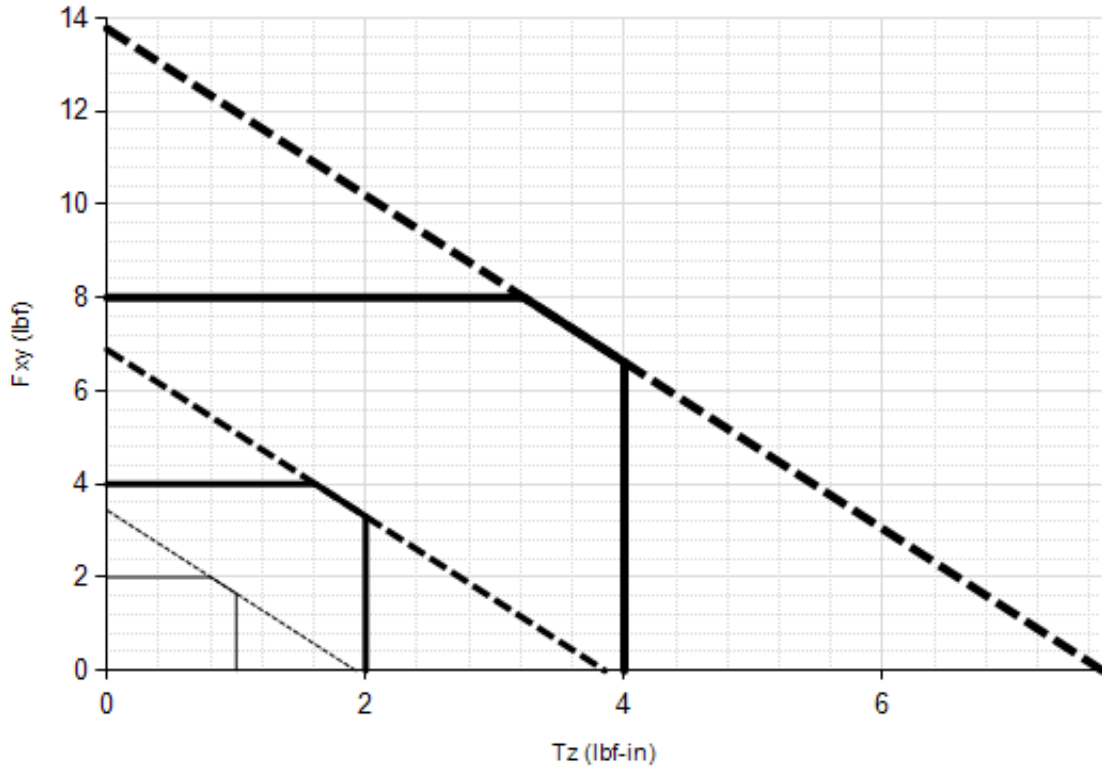

US-2-1
 US-4-2
 US-8-4

5.5.7 Nano43 (SI Calibration Complex Loading)

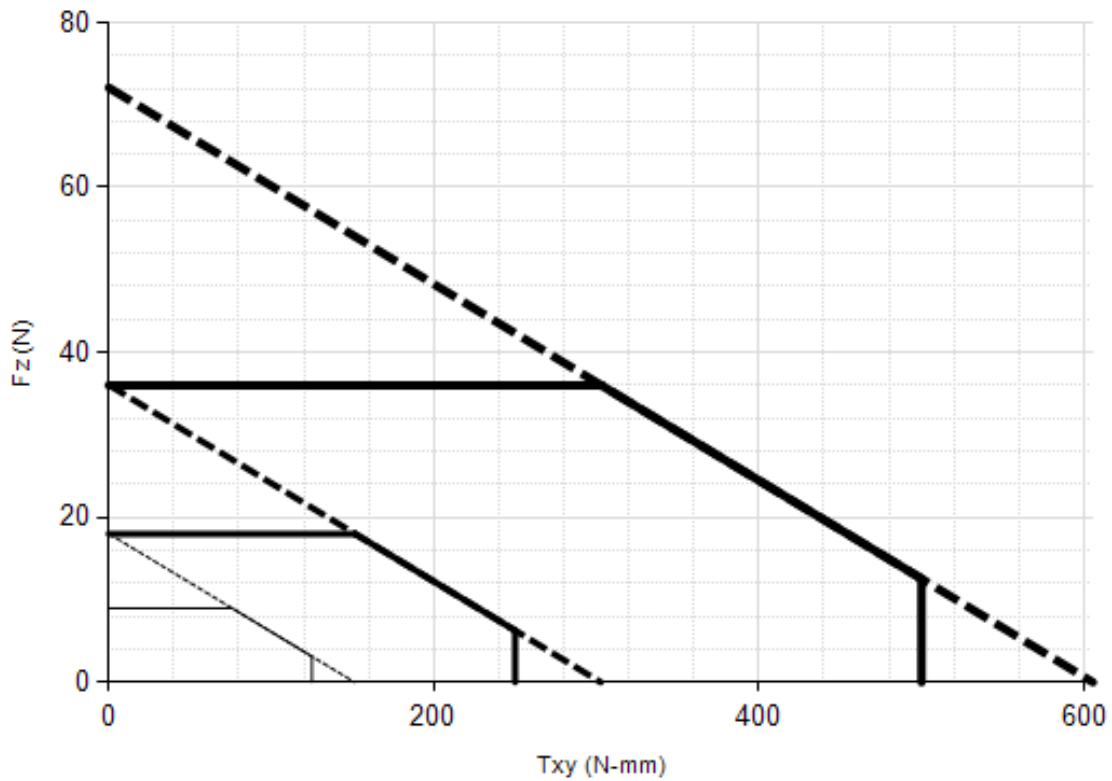
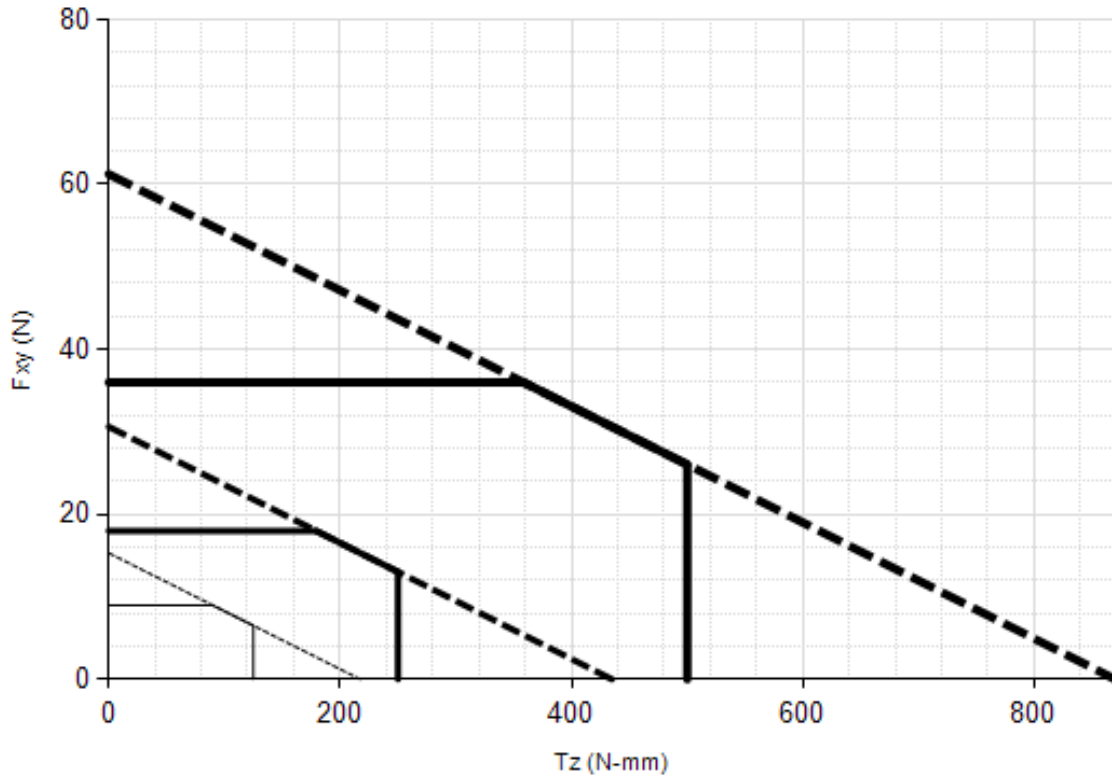

SI-9-0.125
 SI-18-0.25
 SI-36-0.5

5.6 Mini27 Titanium Specifications

In addition to the information in the following sections, refer to the ATI website:

Table 5.27—Mini27 Drawing and Web Links		
Model	Drawing Part Number	ATI Website Address
Mini27	9230-05-1420	https://www.ati-ia.com/products/ft/ft_models.aspx?id=Mini27+Titanium
Mini27-E	9230-05-1553	

5.6.1 Mini27 Titanium Physical Properties

Table 5.28—Mini27 Titanium Physical Properties		
Single-Axis Overload	(US) Standard Units	(SI) Metric Units
Fxy	±330 lbf	±1500 N
Fz	±1000 lbf	±4600 N
Txy	±270 inf-lb	±30 Nm
Tz	±360 inf-lb	±40 Nm
Stiffness (Calculated)		
X-axis & Y-axis forces (Kx, Ky)	1.8x10 ⁵ lb/in	3.1x10 ⁷ N/m
Z-axis force (Kz)	3.6x10 ⁵ lb/in	6.4x10 ⁷ N/m
X-axis & Y-axis torque (Ktx, Kty)	4.0x10 ⁴ lbf-in/rad	4.5x10 ³ Nm/rad
Z-axis torque (Ktz)	5.8x10 ⁴ lbf-in/rad	6.5x10 ³ Nm/rad
Resonant Frequency		
Fx, Fy, Tz	N/A	N/A
Fz, Tx, Ty	N/A	N/A
Physical Specifications		
Weight ¹	0.0736 lb	0.0334 kg
Diameter ¹	1.06 in	27 mm
Height ¹	0.715 in	18.2 mm
Note: 1. Specifications include standard interface plates.		

5.6.2 Calibration Specifications (excludes CTL calibrations)

Table 5.29—Mini27 Titanium Calibrations (excludes CTL calibrations) ^{1, 2}									
Sensor	(US) Standard Calibration	Fx,Fy (lbf)	Fz (lbf)	Tx,Ty (lbf-in)	Tz (lbf-in)	Fx,Fy (lbf)	Fz (lbf)	Tx,Ty (lbf-in)	Tz (lbf-in)
Mini27 Titanium	US-10-18	10	20	18	10	1/400	3/400	1/400	1/800
Mini27 Titanium	US-20-36	20	40	36	20	1/200	3/200	1/200	1/400
Sensor	(SI) Metric Calibration	Fx,Fy (N)	Fz (N)	Tx,Ty (Nm)	Tz (Nm)	Fx,Fy (N)	Fz (N)	Tx,Ty (Nm)	Tz (Nm)
Mini27 Titanium	SI-40-2	40	80	2	1	3/200	3/100	3/8000	1/4000
Mini27 Titanium	SI-80-4	80	160	4	2	3/100	3/50	3/4000	1/2000
					Sensing Ranges		Resolution (DAQ, Net F/T) ³		

Notes:

1. These system resolutions quoted are the effective resolution after dropping four counts of noise. The effective resolution can be improved with filtering.
2. Applied loads must be within range in each of the six axes for the F/T sensor to measure correctly.
3. DAQ resolutions are typical for a 16-bit data acquisition system.

5.6.3 CTL Calibration Specifications

Table 5.30— Mini27 Titanium CTL Calibrations ^{1, 2}									
Sensor	(US) Standard Calibration	Fx,Fy (lbf)	Fz (lbf)	Tx,Ty (lbf-in)	Tz (lbf-in)	Fx,Fy (lbf)	Fz (lbf)	Tx,Ty (lbf-in)	Tz (lbf-in)
Mini27 Titanium	US-10-18	10	20	18	10	1/200	3/200	1/200	1/400
Mini27 Titanium	US-20-36	20	40	36	20	1/100	3/100	1/100	1/200
Sensor	(SI) Metric Calibration	Fx,Fy (N)	Fz (N)	Tx,Ty (Nm)	Tz (Nm)	Fx,Fy (N)	Fz (N)	Tx,Ty (Nm)	Tz (Nm)
Mini27 Titanium	SI-40-2	40	80	2	1	3/100	3/50	3/4000	1/2000
Mini27 Titanium	SI-80-4	80	160	4	2	3/50	3/25	3/2000	1/1000
					Sensing Ranges		Resolution (Controller)		

Notes:

1. CTL resolutions are typical. System resolutions quoted are the effective resolution after dropping eight counts of noise. The effective resolution can be improved with filtering.
2. Applied loads must be within range in each of the six axes for the F/T sensor to measure correctly.

5.6.4 CTL Analog Output

Table 5.31— Mini27 Titanium Analog Output							
Sensor	(US) Standard Calibration	Fx,Fy (lbf)	Fz (lbf)	Tx,Ty,Tz (lbf-in)	Fx,Fy (lbf/V)	Fz (lbf/V)	Tx,Ty,Tz (lbf-in/V)
Mini27 Titanium	US-10-18	±10	±20	±18	1	2	1.8
Mini27 Titanium	US-20-36	±20	±40	±36	2	4	3.6
Sensor	(SI) Metric Calibration	Fx,Fy (N)	Fz (N)	Tx,Ty,Tz (Nmm)	Fx,Fy (N/V)	Fz (N/V)	Tx,Ty,Tz (Nm/V)
Mini27 Titanium	SI-40-2	±40	±80	±2	4	8	0.2
Mini27 Titanium	SI-80-4	±80	±160	±4	8	16	0.4
				Analog Output Range	Analog ±10V Sensitivity ¹		

Notes:
 1. ±5V Sensitivity values are double the listed ±10V Sensitivity values.

5.6.5 CTL Counts Value

Table 5.32—Counts Value					
Sensor	Calibration	Fx, Fy, Fz (/ lbf)	Tx, Ty, Tz (/ lbf-in)	Fx, Fy, Fz (/ N)	Tx, Ty, Tz (/ Nm)
Mini27 Titanium	US-1-18 / SI-40-2	3200	3200	800	32000
Mini27 Titanium	US-20-36 / SI-80-4	1600	1600	400	16000
Mini27 Titanium	Tool Transform Factor	0.01 in/lbf		0.25 mm/N	
			Counts Value – Standard (US)	Counts Value – Metric (SI)	

5.6.6 Mini27 Titanium (US Calibration Complex Loading)

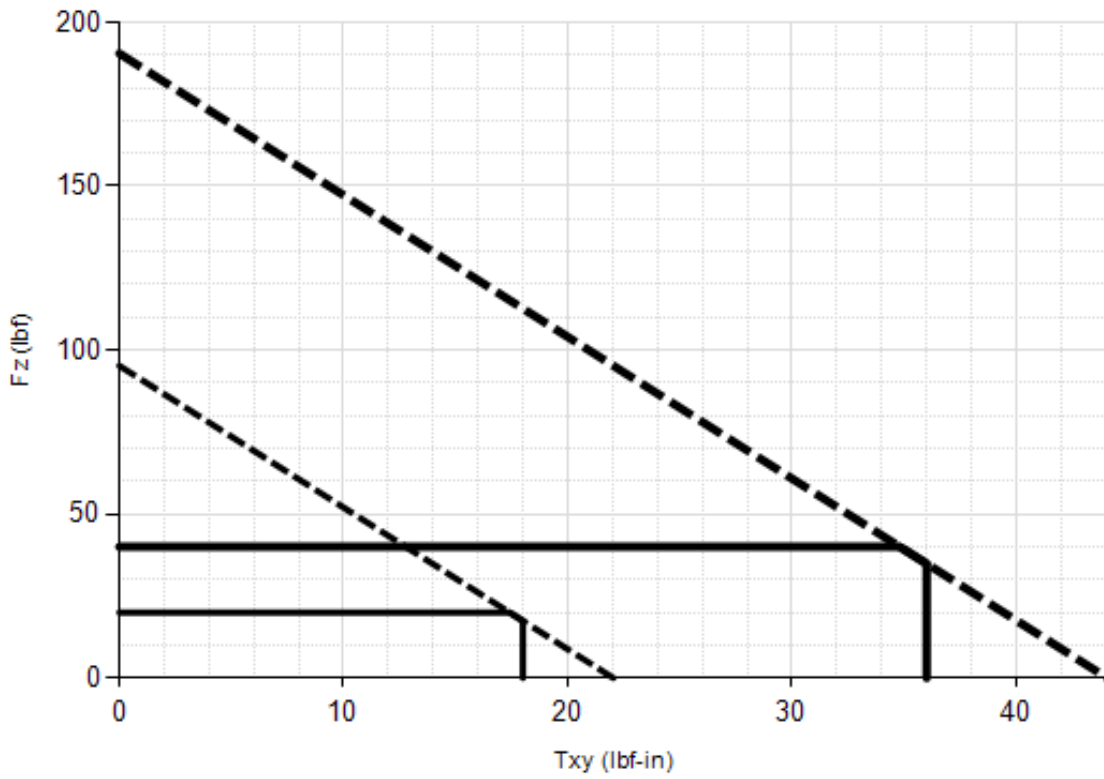
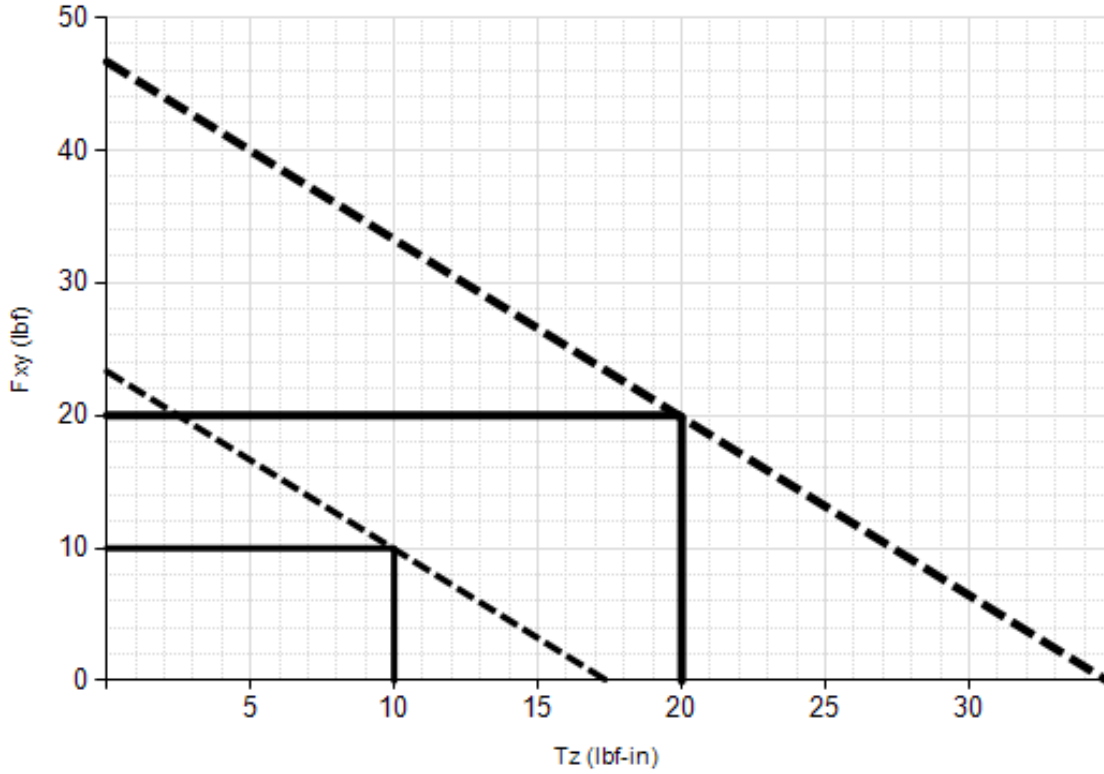

US-10-18
 US-20-36

5.6.7 Mini27 Titanium (SI Calibration Complex Loading)

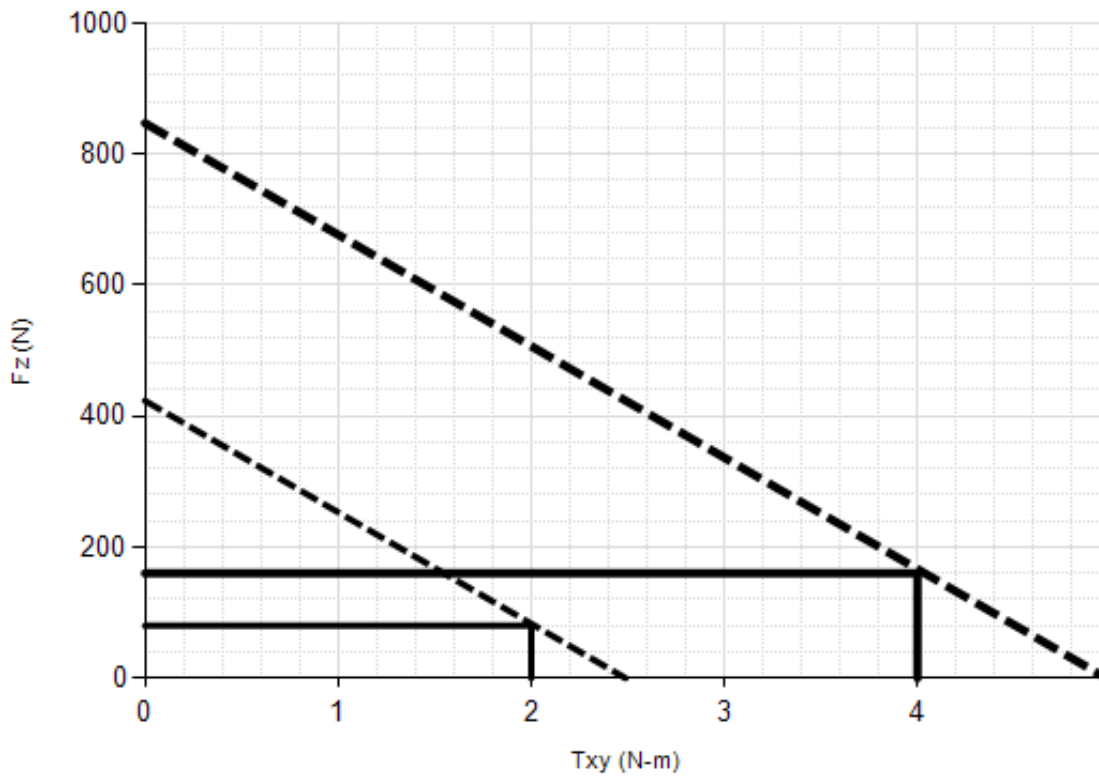
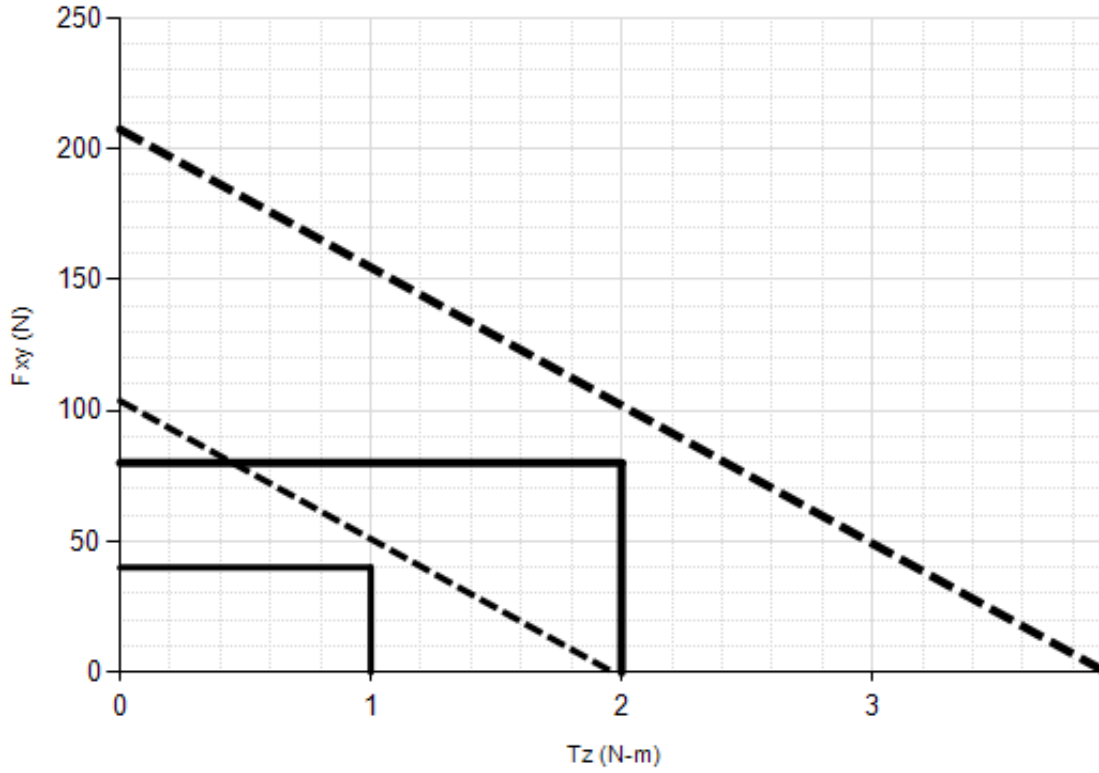

SI-40-2
 SI-80-4

5.7 Mini40 Specifications (Includes IP65/IP68 Versions)

In addition to the information in the following sections, refer to the ATI website:

Model	Drawing Part Number	ATI Website Address
Mini40-A (axial exit) and Mini40-R (radial exit)	9230-05-1278	https://www.ati-ia.com/products/ft/ft_models.aspx?id=Mini40
Mini40-E	9230-05-1314	
Mini40 IP65/IP68	9230-05-1421	https://www.ati-ia.com/products/ft/ft_models.aspx?id=Mini40+IP65%2fIP68

5.7.1 Mini40 Physical Properties

Single-Axis Overload	(US) Standard Units	(SI) Metric Units
Fxy	±180 lbf	±810 N
Fz	±530 lbf	±2400 N
Txy	±170 inf-lb	±19 Nm
Tz	±180 inf-lb	±20 Nm
Stiffness (Calculated)		
X-axis & Y-axis forces (Kx, Ky)	6.1x10 ⁴ lb/in	1.1x10 ⁷ N/m
Z-axis force (Kz)	1.2x10 ⁵ lb/in	2.0x10 ⁷ N/m
X-axis & Y-axis torque (Ktx, Kty)	2.5x10 ⁴ lbf-in/rad	2.8x10 ³ Nm/rad
Z-axis torque (Ktz)	3.6x10 ⁴ lbf-in/rad	4.0x10 ³ Nm/rad
Resonant Frequency		
Fx, Fy, Tz	3200 Hz	3200 Hz
Fz, Tx, Ty	4900 Hz	4900 Hz
Physical Specifications		
Weight ¹	0.11 lb	0.0499 kg
Diameter ¹	1.57 in	40 mm
Height ¹	0.482 in	12.2 mm
Note: 1. Specifications include standard interface plates.		

5.7.2 Mini40 IP65/IP68 Physical Properties

Table 5.35—Mini40 IP65/IP68 Physical Properties		
Single-Axis Overload	(US) Standard Units	(SI) Metric Units
Fxy	±180 lbf	±810 N
Fz	±530 lbf	±2400 N
Txy	±170 inf-lb	±19 Nm
Tz	±180 inf-lb	±20 Nm
Stiffness (Calculated)		
X-axis & Y-axis forces (Kx, Ky)	6.1x10 ⁴ lb/in	1.1x10 ⁷ N/m
Z-axis force (Kz)	1.2x10 ⁵ lb/in	2.0x10 ⁷ N/m
X-axis & Y-axis torque (Ktx, Kty)	2.5x10 ⁴ lbf-in/rad	2.8x10 ³ Nm/rad
Z-axis torque (Ktz)	3.6x10 ⁴ lbf-in/rad	4.0x10 ³ Nm/rad
Resonant Frequency		
Fx, Fy, Tz	1400 Hz	1400 Hz
Fz, Tx, Ty	1300 Hz	1300 Hz
Physical Specifications		
Weight ¹	0.6 lb	0.272 kg
Diameter ¹	2.1 in	53.3 mm
Height ¹	0.83 in	21.1 mm
Note: 1. Specifications include standard interface plates.		



CAUTION: When submerged, IP68 transducers exhibit a decrease in Fz range related to the submersion depth. This loss is the result of pressure-induced preloading on the transducer. The preload can be masked by biasing the transducer at the depth prior to applying the load to be measured. The following estimates are for room temperature fresh water at sea level.

Submersion Depth		
IP68 Mini40	US	Metric
Fz preload at 4 m depth	17.0 lb	75.5 N
Fz preload at other depths	-1.29 lb/ft × depthInFeet	-18.9 N/m × depthInMeters

5.7.3 Calibration Specifications (excludes CTL calibrations)

Table 5.36— Mini40 Calibrations (excludes CTL calibrations) ^{1, 2}									
Sensor	(US) Standard Calibration	Fx,Fy (lbf)	Fz ³ (lbf)	Tx,Ty (lbf-in)	Tz (lbf-in)	Fx,Fy (lbf)	Fz ³ (lbf)	Tx,Ty (lbf-in)	Tz (lbf-in)
Mini40	US-5-10	5	15	10	10	1/800	1/400	1/800	1/800
Mini40	US-10-20	10	30	20	20	1/400	1/200	1/400	1/400
Mini40	US-20-40	20	60	40	40	1/200	1/100	1/200	1/200
Sensor	(SI) Metric Calibration	Fx,Fy (N)	Fz ³ (N)	Tx,Ty (Nm)	Tz (Nm)	Fx,Fy (N)	Fz ³ (N)	Tx,Ty (Nm)	Tz (Nm)
Mini40	SI-20-1	20	60	1	1	1/200	1/100	1/8000	1/8000
Mini40	SI-40-2	40	120	2	2	1/100	1/50	1/4000	1/4000
Mini40	SI-80-4	80	240	4	4	1/50	1/25	1/2000	1/2000
		Sensing Ranges				Resolution (DAQ, Net F/T)⁴			

Notes:

1. These system resolutions quoted are the effective resolution after dropping four counts of noise. The effective resolution can be improved with filtering.
2. Applied loads must be within range in each of the six axes for the F/T sensor to measure correctly.
3. For IP68 version see caution on physical properties page.
4. DAQ resolutions are typical for a 16-bit data acquisition system.

5.7.4 CTL Calibration Specifications

Table 5.37— Mini40 CTL Calibrations ^{1, 2}									
Sensor	(US) Standard Calibration	Fx,Fy (lbf)	Fz ³ (lbf)	Tx,Ty (lbf-in)	Tz (lbf-in)	Fx,Fy (lbf)	Fz ³ (lbf)	Tx,Ty (lbf-in)	Tz (lbf-in)
Mini40	US-5-10	5	15	10	10	1/400	1/200	1/400	1/400
Mini40	US-10-20	10	30	20	20	1/200	1/100	1/200	1/200
Mini40	US-20-40	20	60	40	40	1/100	1/50	1/100	1/100
Sensor	(SI) Metric Calibration	Fx,Fy (N)	Fz ³ (N)	Tx,Ty (Nm)	Tz (Nm)	Fx,Fy (N)	Fz ³ (N)	Tx,Ty (Nm)	Tz (Nm)
Mini40	SI-20-1	20	60	1	1	1/100	1/50	1/4000	1/4000
Mini40	SI-40-2	40	120	2	2	1/50	1/25	1/2000	1/2000
Mini40	SI-80-4	80	240	4	4	1/25	2/25	1/1000	1/1000
Sensing Ranges						Resolution (Controller)			

Notes:

1. CTL resolutions are typical. System resolutions quoted are the effective resolution after dropping eight counts of noise. The effective resolution can be improved with filtering.
2. Applied loads must be within range in each of the six axes for the F/T sensor to measure correctly.
3. For IP68 version see caution on physical properties page.

5.7.5 CTL Analog Output

Table 5.38— Mini40 Analog Output							
Sensor	(US) Standard Calibration	Fx,Fy (lbf)	Fz ² (lbf)	Tx,Ty,Tz (lbf-in)	Fx,Fy (lbf/V)	Fz ² (lbf/V)	Tx,Ty,Tz (lbf-in/V)
Mini40	US-5-10	±5	±15	±10	0.5	1.5	1
Mini40	US-10-20	±10	±30	±20	1	3	2
Mini40	US-20-40	±20	±60	±40	2	6	4
Sensor	(SI) Metric Calibration	Fx,Fy (N)	Fz ² (N)	Tx,Ty,Tz (Nm)	Fx,Fy (N/V)	Fz ² (N/V)	Tx,Ty,Tz (Nm/V)
Mini40	SI-20-1	±20	±60	±1	2	6	0.1
Mini40	SI-40-2	±40	±120	±2	4	12	0.2
Mini40	SI-80-4	±80	±240	±4	8	24	0.4
Analog Output Range					Analog ±10V Sensitivity¹		

Notes:

1. ±5V Sensitivity values are double the listed ±10V Sensitivity values.
2. For IP68 version see caution on physical properties page.

5.7.6 CTL Counts Value

Table 5.39—Counts Value					
Sensor	Calibration	Fx, Fy, Fz (/ lbf)	Tx, Ty, Tz (/ lbf-in)	Fx, Fy, Fz (/ N)	Tx, Ty, Tz (/ Nm)
Mini40	US-5-10 / SI-20-1	3200	3200	800	32000
Mini40	US-10-20 / SI-40-2	1600	1600	400	16000
Mini40	US-20-40 / SI-80-4	800	800	200	8000
Mini40	Tool Transform Factor	0.01 in/lbf		0.25 mm/N	
Counts Value – Standard (US)			Counts Value – Metric (SI)		

5.7.7 Mini40 (US Calibration Complex Loading)(Includes IP65/IP68)¹

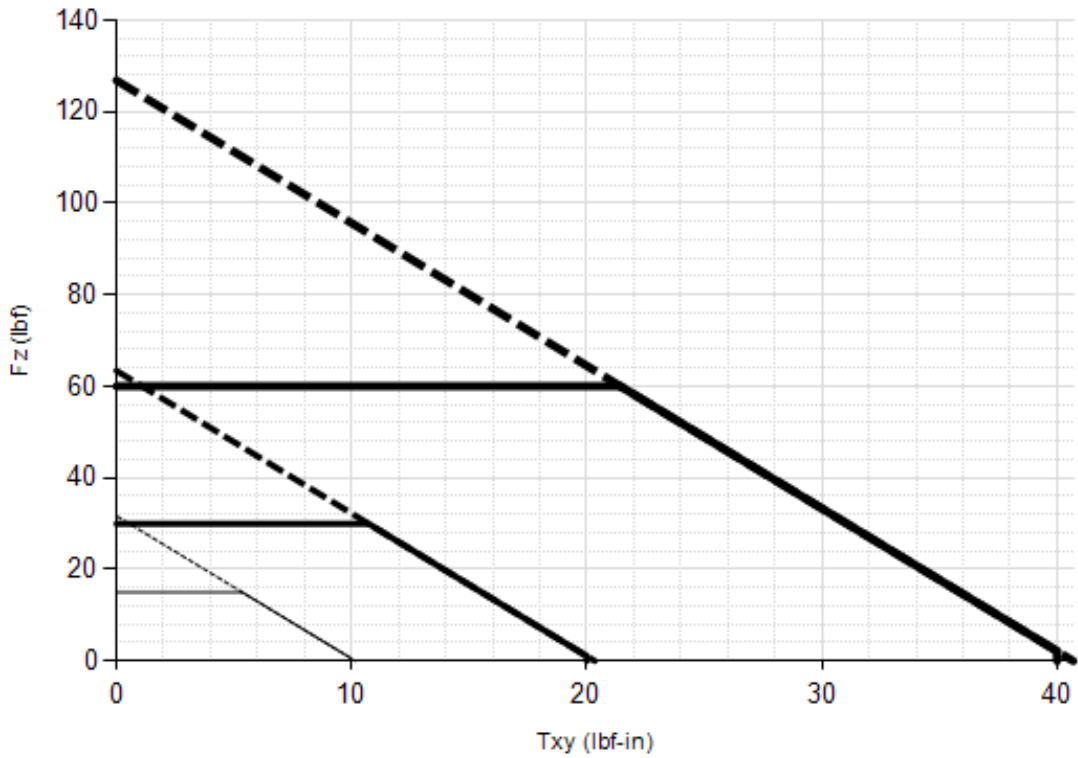
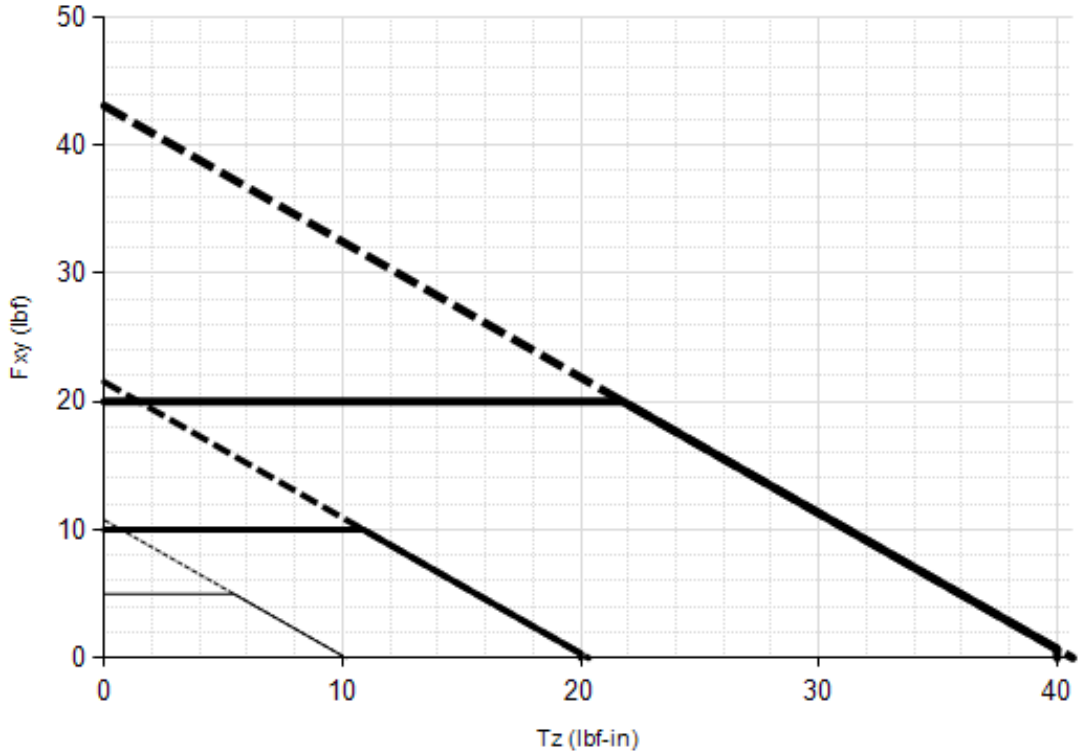

US-5-10
 US-10-20
 US-20-40

Note: 1. For IP68 version see caution on physical properties page.

5.7.8 Mini40 (SI Calibration Complex Loading)(Includes IP65/IP68)¹

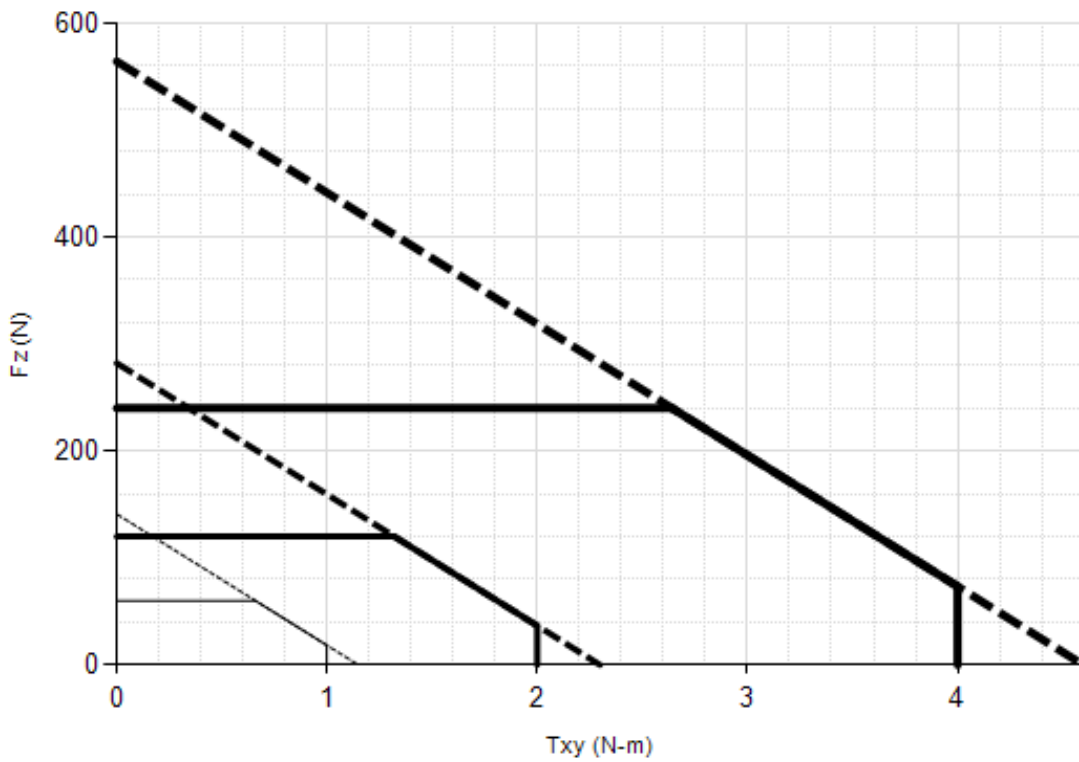

SI-20-1
 SI-40-2
 SI-80-4

Note: 1. For IP68 version see caution on physical properties page.

5.8 Mini43LP Specifications

In addition to the information in the following sections, refer to the ATI website:

Table 5.40—Mini43LP Drawing and Web Links		
Model	Drawing Part Number	ATI Website Address
Mini43LP	9630-05-0005	http://www.ati-ia.com/app_content/Documents/9630-05-0005.auto.pdf

5.8.1 Mini43LP Physical Properties

Table 5.41—Mini43LP Physical Properties		
Single-Axis Overload	(US) Standard Units	(SI) Metric Units
Fxy	280 lb	1200 N
Fz	280 lb	1200 N
Txy	130 lb-in	15 Nm
Tz	220 lb-in	25 Nm
Stiffness (Calculated)		
X-axis & Y-axis forces (Kx, Ky)	1.9x10 ⁵ lb/in	3.3x10 ⁷ N/m
Z-axis force (Kz)	1.2x10 ⁵ lb/in	2.1x10 ⁷ N/m
X-axis & Y-axis torque (Ktx, Kty)	3.0x10 ⁴ lbf-in/rad	3.4x10 ³ Nm/rad
Z-axis torque (Ktz)	1.0x10 ⁵ lbf-in/rad	1.1x10 ⁴ Nm/rad
Resonant Frequency		
Fx, Fy, Tz	5200 Hz	
Fz, Tx, Ty	7300 Hz	
Physical Specifications		
Weight ¹	0.11 lb	0.05 kg
Diameter ¹	1.69 in	43 mm
Height ¹	0.31 in	7.9 mm

5.8.2 Calibration Specifications

Table 5.42—Mini43LP Calibrations ^{1, 2}									
Sensor	(US) Standard Calibration	Fx,Fy (lb)	Fz (lb)	Tx,Ty (lb-in)	Tz (lb-in)	Fx,Fy (lb)	Fz (lb)	Tx,Ty (lb-in)	Tz (lb-in)
Mini43LP	US-12.5-6	12.5	12.5	6	11	1/320	1/320	1/648	1/368
Mini43LP	US-25-12.5	25	25	12.5	22	1/160	1/160	1/324	1/184
Mini43LP	US-50-25	50	50	25	44	1/80	1/80	1/162	1/92
Sensor	(SI) Metric Calibration	Fx,Fy (N)	Fz (N)	Tx,Ty (Nm)	Tz (Nm)	Fx,Fy (N)	Fz (N)	Tx,Ty (Nm)	Tz (Nm)
Mini43LP	SI-62-0.75	62	62	0.75	1.25	1/64	1/64	1/5120	1/3280
Mini43LP	SI-125-1.5	125	125	1.5	2.5	1/32	1/32	1/2560	1/1640
Mini43LP	SI-250-3	250	250	3	5	1/16	1/16	1/1360	1/820
Sensing Ranges						Resolution³			

Notes:

- These system resolutions quoted are the effective resolution after dropping four counts of noise. The effective resolution can be improved with filtering.
- Applied loads must be within range in each of the six axes for the F/T sensor to measure correctly.
- Resolutions are typical for a 16-bit data.

5.8.3 CTL Analog Output

Table 5.43—Mini43LP Analog Output							
Sensor	(US) Standard Calibration	Fx,Fy (lbf)	Fz ² (lbf)	Tx,Ty,Tz (lbf-in)	Fx,Fy (lbf/V)	Fz ² (lbf/V)	Tx,Ty,Tz (lbf-in/V)
Mini43LP	US-12.5-6	±12.5	±6	±11	1.25	0.6	1.1
Mini43LP	US-25-12.5	±25	±12.5	±22	2.5	1.25	2.2
Mini43LP	US-50-25	±50	±25	±44	5	2.5	4.4
Sensor	(SI) Metric Calibration	Fx,Fy (N)	Fz ² (N)	Tx,Ty,Tz (Nm)	Fx,Fy (N/V)	Fz ² (N/V)	Tx,Ty,Tz (Nm/V)
Mini43LP	SI-62-0.75	±62	±0.75	±1.25	6.2	0.075	0.125
Mini43LP	SI-125-1.5	±125	±1.5	±2.5	12.5	0.15	0.25
Mini43LP	SI-250-3	±250	±3	±5	25	0.3	0.5
Analog Output Range					Analog ±10V Sensitivity¹		

Notes:
 1. ±5V Sensitivity values are double the listed ±10V Sensitivity values.

5.8.4 CTL Counts Value

Table 5.44—Counts Value					
Sensor	Calibration	Fx, Fy, Fz (/ lbf)	Tx, Ty, Tz (/ lbf-in)	Fx, Fy, Fz (/ N)	Tx, Ty, Tz (/ Nm)
Mini43LP	US-12.5-6 / SI-62-0.75	3200	3680	640	32800
Mini43LP	US-25-12.5 / SI-125-1.5	1600	1840	320	16400
Mini43LP	US-50-25 / SI-250-3	800	920	160	8200
Counts Value – Standard (US)			Counts Value – Metric (SI)		

5.8.5 Mini43LP (US Calibration Complex Loading)

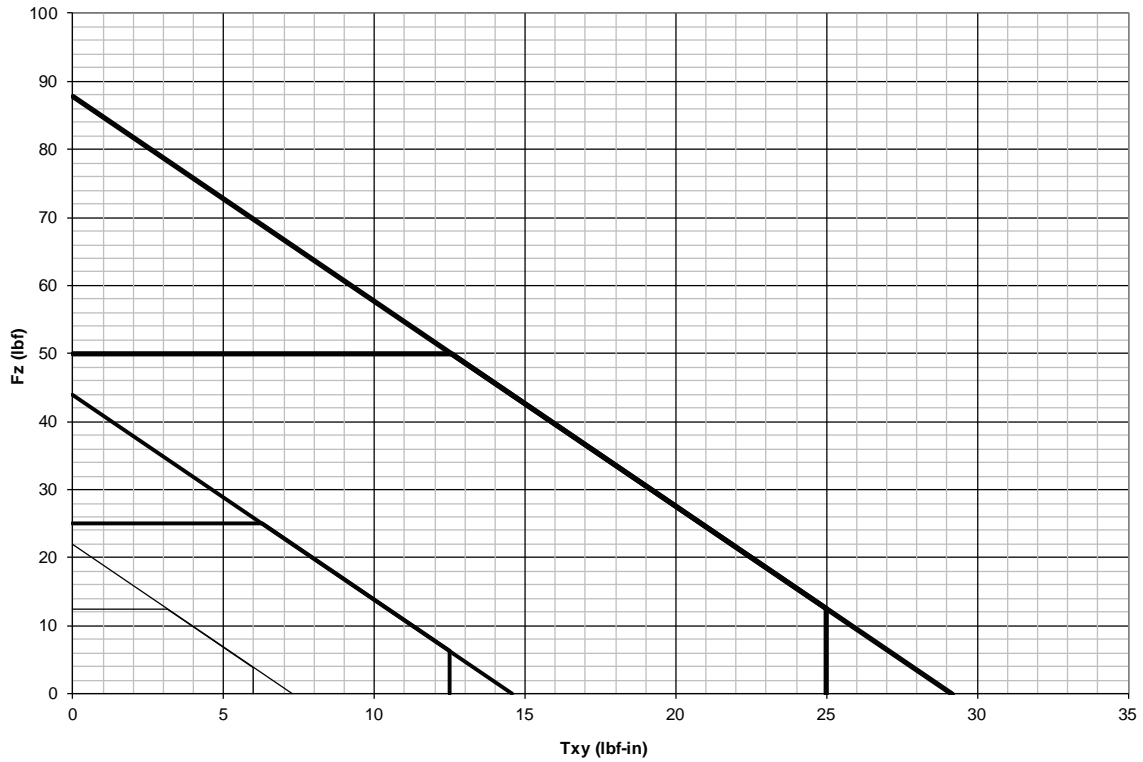
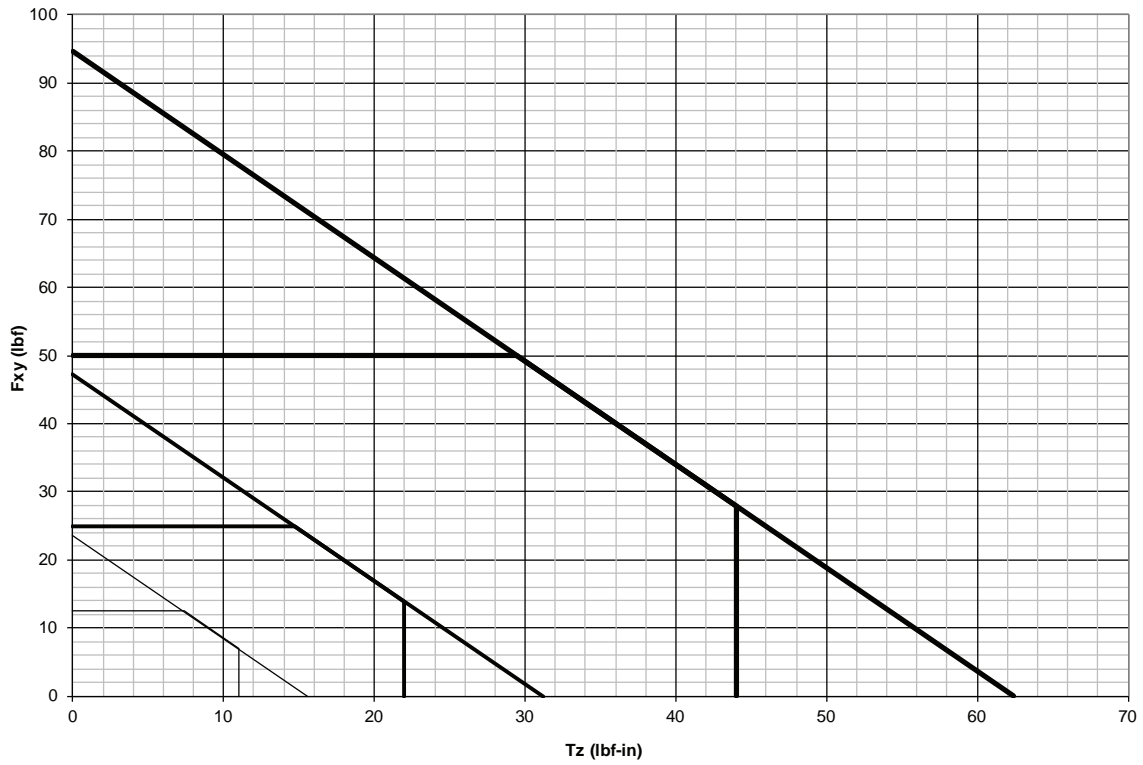

— US-12.5-6 Range
— US-50-25 Range
— US-25-12.5 Range

5.8.6 Mini43LP (SI Calibration Complex Loading)

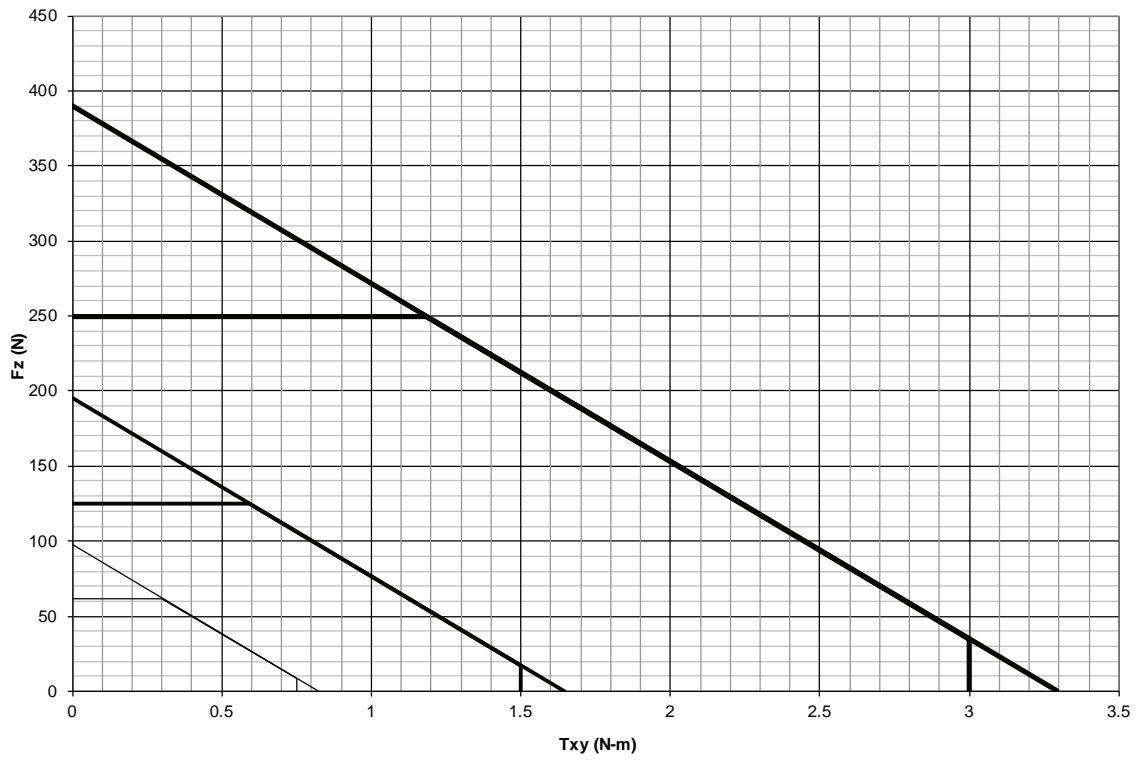
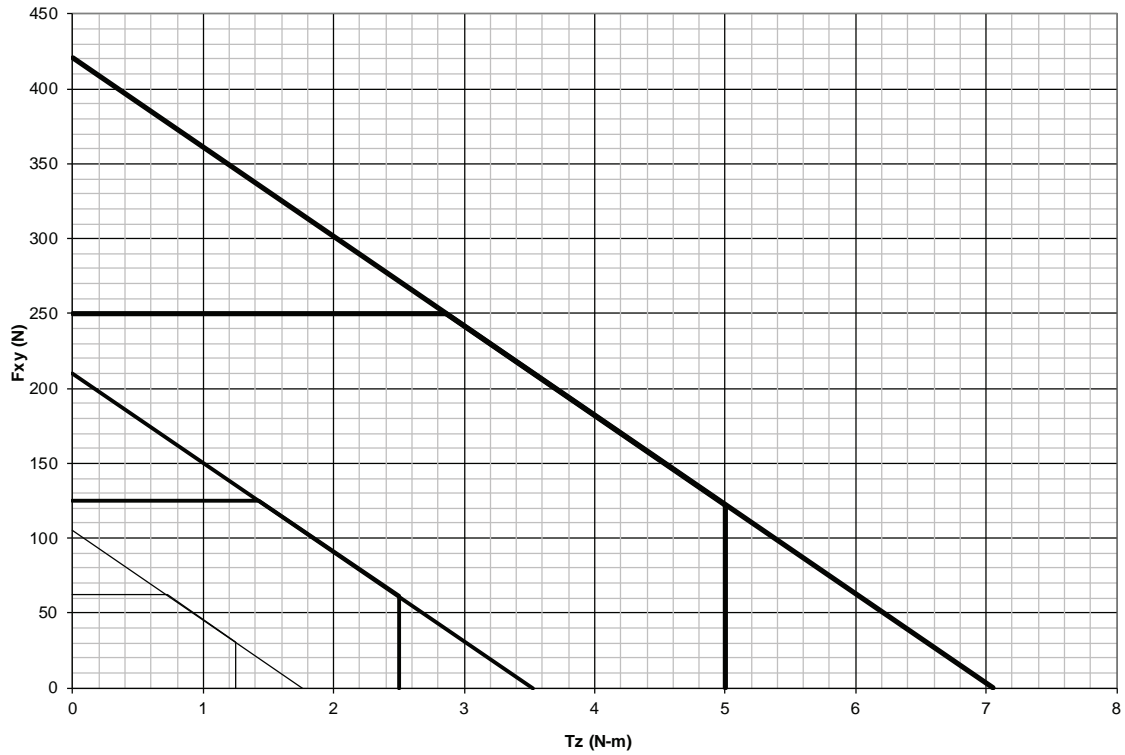

— SI-62-0.75 Range — SI-125-1.5 Range — SI-250-3 Range

5.9 Mini45 Titanium Specifications

In addition to the information in the following sections, refer to the ATI website:

Table 5.45—Mini45 Drawing and Web Links		
Model	Drawing Part Number	ATI Website Address
Mini45 Titanium Axial Exit	9230-05-1440	https://www.ati-ia.com/products/ft/ft_models.aspx?id=Mini45+Titanium
Mini45 Titanium Right Angle E-Exit	9230-05-1441	

5.9.1 Mini45 Titanium Physical Properties

Table 5.46—Mini45 Titanium Physical Properties		
Single-Axis Overload	(US) Standard Units	(SI) Metric Units
Fxy	±670 lbf	±3000 N
Fz	±1400 lbf	±6400 N
Txy	±590 inf-lb	±67 Nm
Tz	±720 inf-lb	±81 Nm
Stiffness (Calculated)		
X-axis & Y-axis forces (Kx, Ky)	2.5x10 ⁵ lb/in	4.3x10 ⁷ N/m
Z-axis force (Kz)	3.3x10 ⁵ lb/in	5.7x10 ⁷ N/m
X-axis & Y-axis torque (Ktx, Kty)	8.6x10 ⁴ lbf-in/rad	9.7x10 ³ Nm/rad
Z-axis torque (Ktz)	1.8x10 ⁵ lbf-in/rad	2.0x10 ⁴ Nm/rad
Resonant Frequency		
Fx, Fy, Tz	5800 Hz	5800 Hz
Fz, Tx, Ty	4600 Hz	4600 Hz
Physical Specifications		
Weight ¹	0.22 lb	0.0998 kg
Diameter ¹	1.77 in	45 mm
Height ¹	0.69 in	17.5 mm
Note: 1. Specifications include standard interface plates.		

5.9.2 Calibration Specifications (excludes CTL calibrations)

Table 5.47— Mini45 Titanium Calibrations (excludes CTL calibrations) ^{1, 2}										
Sensor	(US) Standard Calibration	Fx,Fy (lbf)	Fz (lbf)	Tx,Ty (lbf-in)	Tz (lbf-in)	Fx,Fy (lbf)	Fz (lbf)	Tx,Ty (lbf-in)	Tz (lbf-in)	
Mini45 Titanium	US-15-25	15	30	25	25	3/800	1/160	1/300	1/400	
Mini45 Titanium	US-30-50	30	60	50	50	3/400	1/80	1/150	1/200	
Mini45 Titanium	US-60-100	60	120	100	100	3/200	1/40	1/75	1/100	
Sensor	(SI) Metric Calibration	Fx,Fy (N)	Fz (N)	Tx,Ty (Nm)	Tz (Nm)	Fx,Fy (N)	Fz (N)	Tx,Ty (Nm)	Tz (Nm)	
Mini45 Titanium	SI-60-3	60	120	3	3	1/60	7/240	3/8000	1/3200	
Mini45 Titanium	SI-120-6	120	240	6	6	1/30	7/120	3/4000	1/1600	
Mini45 Titanium	SI-240-12	240	480	12	12	1/15	7/60	3/2000	1/800	
					Sensing Ranges	Resolution (DAQ, Net F/T) ³				

Notes:

1. These system resolutions quoted are the effective resolution after dropping four counts of noise. The effective resolution can be improved with filtering.
2. Applied loads must be within range in each of the six axes for the F/T sensor to measure correctly.
3. DAQ resolutions are typical for a 16-bit data acquisition system.

5.9.3 CTL Calibration Specifications

Table 5.48— Mini45 Titanium CTL Calibrations ^{1, 2}										
Sensor	(US) Standard Calibration	Fx,Fy (lbf)	Fz (lbf)	Tx,Ty (lbf-in)	Tz (lbf-in)	Fx,Fy (lbf)	Fz (lbf)	Tx,Ty (lbf-in)	Tz (lbf-in)	
Mini45 Titanium	US-15-25	15	30	25	25	3/400	1/80	1/150	1/200	
Mini45 Titanium	US-30-50	30	60	50	50	3/200	1/40	1/75	1/100	
Mini45 Titanium	US-60-100	60	120	100	100	3/100	1/20	2/75	1/50	
Sensor	(SI) Metric Calibration	Fx,Fy (N)	Fz (N)	Tx,Ty (Nm)	Tz (Nm)	Fx,Fy (N)	Fz (N)	Tx,Ty (Nm)	Tz (Nm)	
Mini45 Titanium	SI-60-3	60	120	3	3	1/30	7/120	3/4000	1/1600	
Mini45 Titanium	SI-120-6	120	240	6	6	1/15	7/60	3/2000	1/800	
Mini45 Titanium	SI-240-12	240	480	12	12	2/15	7/30	3/1000	1/400	
					Sensing Ranges	Resolution (Controller)				

Notes:

1. CTL resolutions are typical. System resolutions quoted are the effective resolution after dropping eight counts of noise. The effective resolution can be improved with filtering.
2. Applied loads must be within range in each of the six axes for the F/T sensor to measure correctly.

5.9.4 CTL Analog Output

Table 5.49— Mini45 Titanium Analog Output							
Sensor	(US) Standard Calibration	Fx,Fy (lbf)	Fz (lbf)	Tx,Ty,Tz (lbf-in)	Fx,Fy (lbf/V)	Fz (lbf/V)	Tx,Ty,Tz (lbf-in/V)
Mini45 Titanium	US-15-25	±15	±30	±25	1.5	3	2.5
Mini45 Titanium	US-30-50	±30	±60	±50	3	6	5
Mini45 Titanium	US-60-100	±60	±120	±100	6	12	10
Sensor	(SI) Metric Calibration	Fx,Fy (N)	Fz (N)	Tx,Ty,Tz (Nmm)	Fx,Fy (N/V)	Fz (N/V)	Tx,Ty,Tz (Nm/V)
Mini45 Titanium	SI-60-3	±60	±120	±3	6	12	0.3
Mini45 Titanium	SI-120-6	±120	±240	±6	12	24	0.6
Mini45 Titanium	SI-240-12	±240	±480	±12	24	48	1.2
Analog Output Range					Analog ±10V Sensitivity¹		

Notes:
 1. ±5V Sensitivity values are double the listed ±10V Sensitivity values.

5.9.5 CTL Counts Value

Table 5.50—Counts Value					
Sensor	Calibration	Fx, Fy, Fz (/ lbf)	Tx, Ty, Tz (/ lbf-in)	Fx, Fy, Fz (/ N)	Tx, Ty, Tz (/ Nm)
Mini45 Titanium	US-15-25 / SI-60-3	640	704	128	6016
Mini45 Titanium	US-30-50 / SI-120-6	320	352	64	3008
Mini45 Titanium	US-60-100 / SI-240-12	160	176	32	1504
Mini45 Titanium	Tool Transform Factor	0.009091 in/lbf		0.21277 mm/N	
		Counts Value – Standard (US)		Counts Value – Metric (SI)	

5.9.6 Mini45 Titanium (US Calibration Complex Loading)

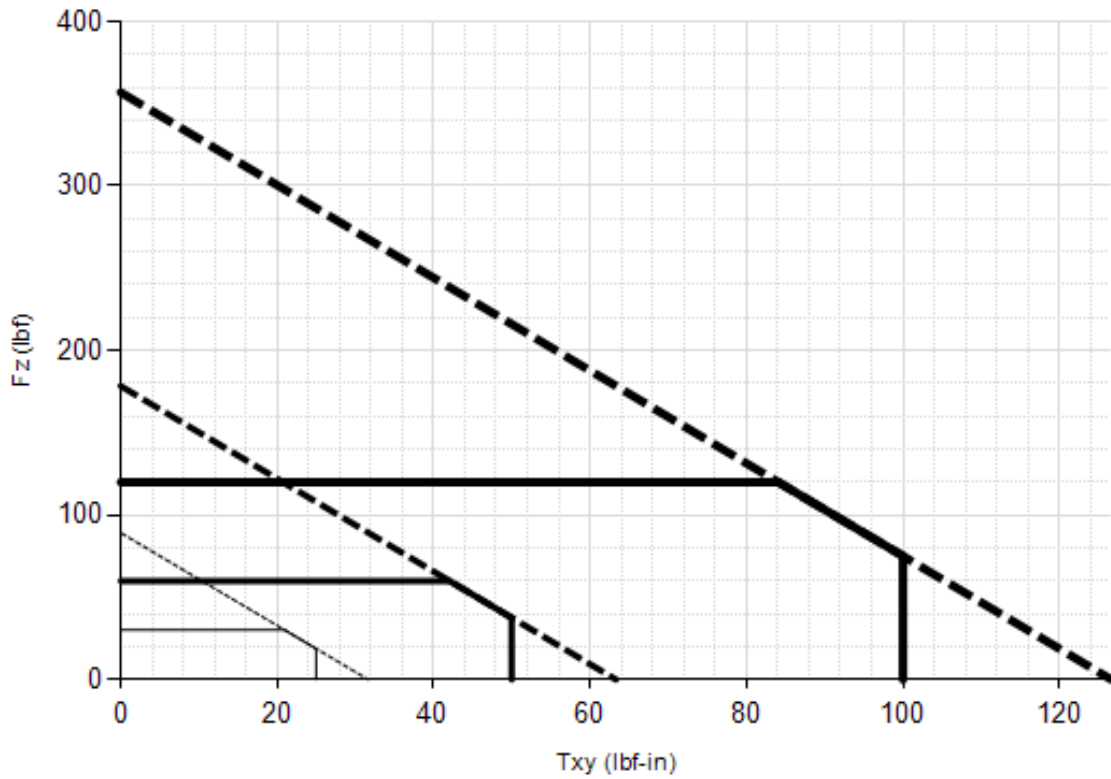
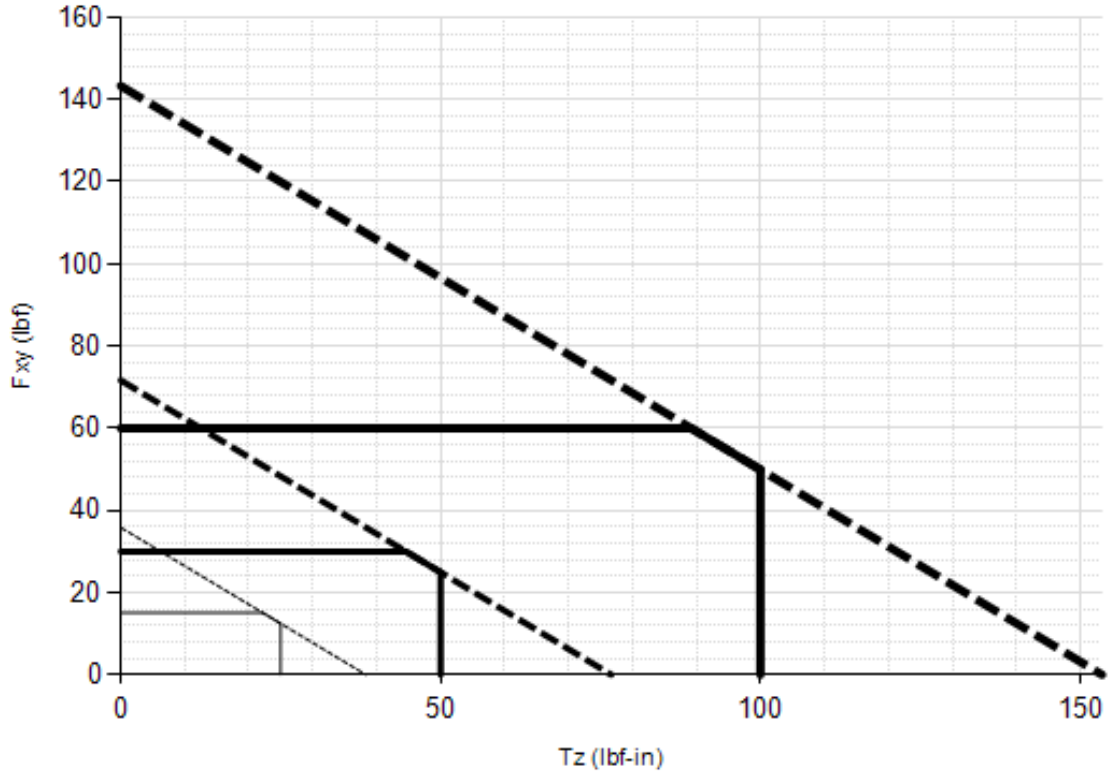

US-15-25
 US-30-50
 US-60-100

5.9.7 Mini45 Titanium (SI Calibration Complex Loading)

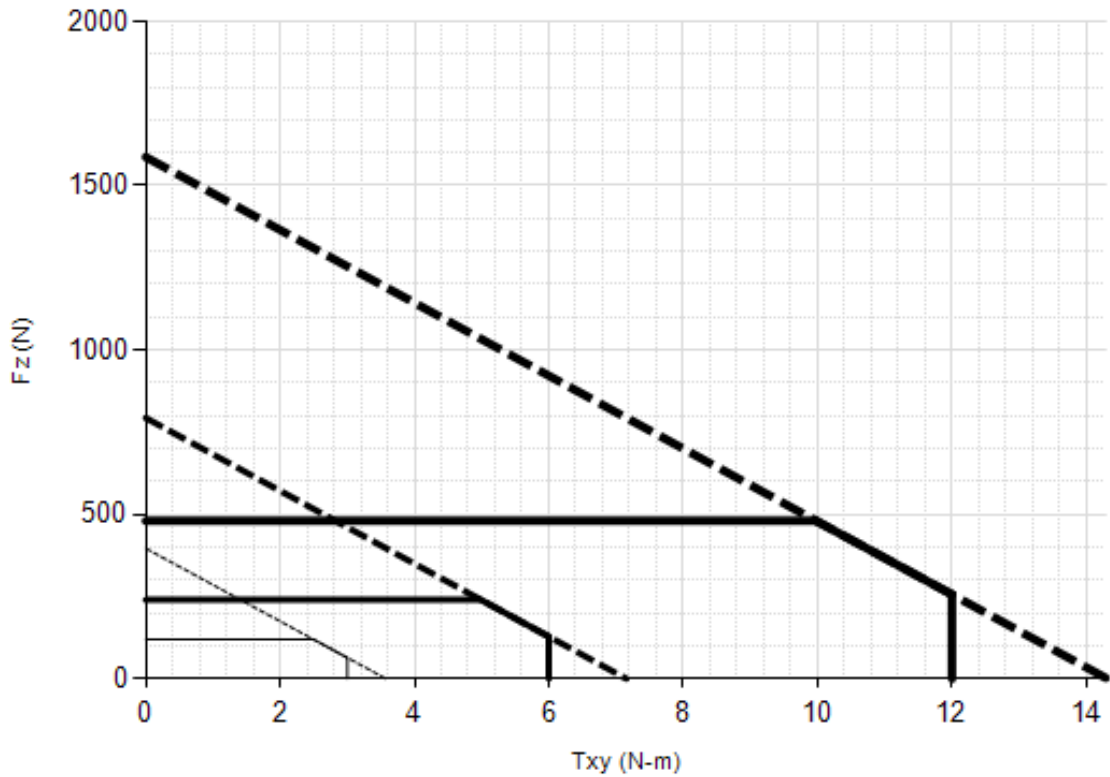
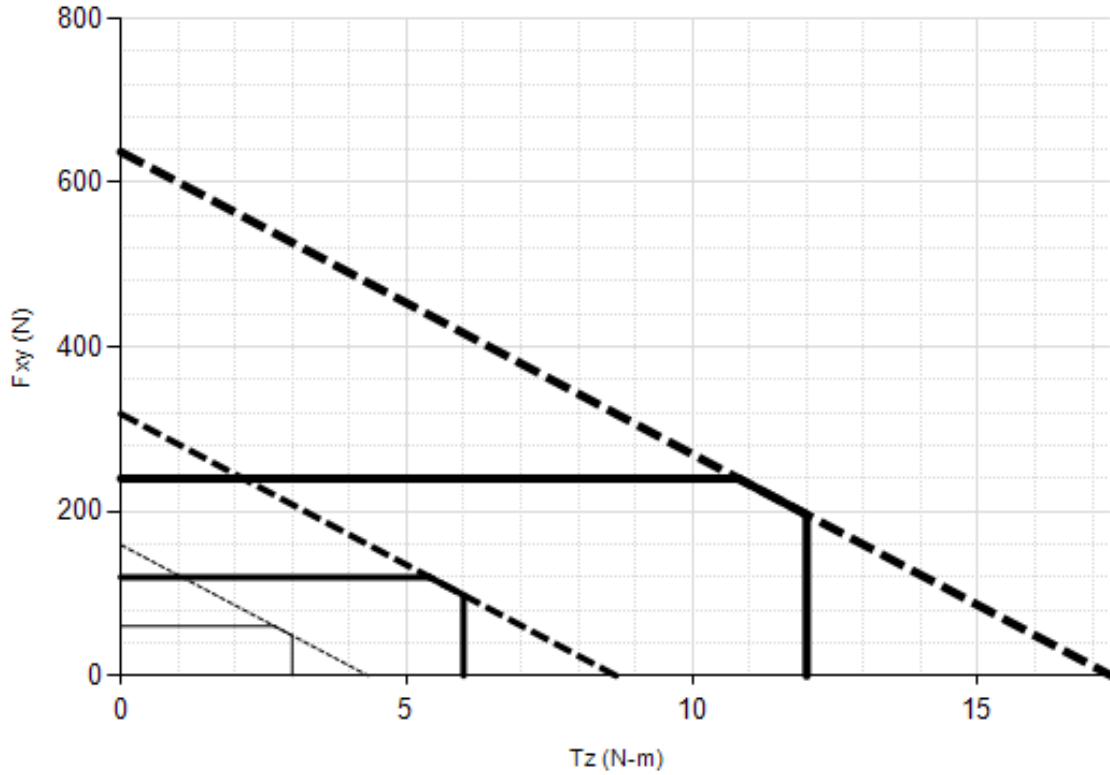

SI-60-3
 SI-120-6
 SI-240-12

5.10 Mini45 Specifications (Includes IP65/IP68 Versions)

In addition to the information in the following sections, refer to the ATI website:

Table 5.51—Mini45 Drawing and Web Links		
Model	Drawing Part Number	ATI Website Address
Mini45-A (axial exit) and Mini45-R (radial exit)	9230-05-1094	https://www.ati-ia.com/products/ft/ft_models.aspx?id=Mini45
Mini45-E	9230-05-1315	
Mini45-ERA	9230-05-1338	
Mini45-AE	9230-05-1431	
Mini45 IP65/IP68	9230-05-1443	https://www.ati-ia.com/products/ft/ft_models.aspx?id=Mini45+IP65%2fIP68

5.10.1 Mini45 Physical Properties

Table 5.52—Mini45 Physical Properties		
Single-Axis Overload	(US) Standard Units	(SI) Metric Units
Fxy	±1100 lbf	±5100 N
Fz	±2300 lbf	±10000 N
Txy	±1000 inf-lb	±110 Nm
Tz	±1200 inf-lb	±140 Nm
Stiffness (Calculated)		
X-axis & Y-axis forces (Kx, Ky)	4.2x10 ⁵ lb/in	7.4x10 ⁷ N/m
Z-axis force (Kz)	5.6x10 ⁵ lb/in	9.8x10 ⁷ N/m
X-axis & Y-axis torque (Ktx, Kty)	1.5x10 ⁵ lbf-in/rad	1.7x10 ⁴ Nm/rad
Z-axis torque (Ktz)	3.1x10 ⁵ lbf-in/rad	3.5x10 ⁴ Nm/rad
Resonant Frequency		
Fx, Fy, Tz	5600 Hz	5600 Hz
Fz, Tx, Ty	5400 Hz	5400 Hz
Physical Specifications		
Weight ¹	0.202 lb	0.0917 kg
Diameter ¹	1.77 in	45 mm
Height ¹	0.618 in	15.7 mm
Note: 1. Specifications include standard interface plates.		

5.10.2 Mini45 IP65/IP68 Physical Properties

Table 5.53—Mini45 IP65/IP68 Physical Properties		
Single-Axis Overload	(US) Standard Units	(SI) Metric Units
Fxy	±1100 lbf	±5100 N
Fz	±2300 lbf	±10000 N
Txy	±1000 inf-lb	±110 Nm
Tz	±1200 inf-lb	±140 Nm
Stiffness (Calculated)		
X-axis & Y-axis forces (Kx, Ky)	4.2x10 ⁵ lb/in	7.4x10 ⁷ N/m
Z-axis force (Kz)	5.6x10 ⁵ lb/in	9.8x10 ⁷ N/m
X-axis & Y-axis torque (Ktx, Kty)	1.5x10 ⁵ lbf-in/rad	1.7x10 ⁴ Nm/rad
Z-axis torque (Ktz)	3.1x10 ⁵ lbf-in/rad	3.5x10 ⁴ Nm/rad
Resonant Frequency		
Fx, Fy, Tz	5200 Hz	5200 Hz
Fz, Tx, Ty	4200 Hz	4200 Hz
Physical Specifications		
Weight ¹	0.861 lb	0.391 kg
Diameter ¹	2.28 in	57.9 mm
Height ¹	0.988 in	25.1 mm
Note: 1. Specifications include standard interface plates.		



CAUTION: When submerged, IP68 transducers exhibit a decrease in Fz range related to the submersion depth. This loss is the result of pressure-induced preloading on the transducer. The preload can be masked by biasing the transducer at the depth prior to applying the load to be measured. The following estimates are for room temperature fresh water at sea level.

Submersion Depth		
IP68 Mini45	US	Metric
Fz preload at 4 m depth	17.0 lb	75.5 N
Fz preload at other depths	-1.29 lb/ft × depthInFeet	-18.9 N/m × depthInMeters

5.10.3 Calibration Specifications (excludes CTL calibrations)

Table 5.54— Mini45 Calibrations (excludes CTL calibrations) ^{1, 2}									
Sensor	(US) Standard Calibration	Fx,Fy (lbf)	Fz ³ (lbf)	Tx,Ty (lbf-in)	Tz (lbf-in)	Fx,Fy (lbf)	Fz ³ (lbf)	Tx,Ty (lbf-in)	Tz (lbf-in)
Mini45	US-30-40	30	60	40	40	1/80	1/80	1/88	1/176
Mini45	US-60-80	60	120	80	80	1/40	1/40	1/44	1/88
Mini45	US-120-160	120	240	160	160	1/20	1/20	1/22	1/44
Sensor	(SI) Metric Calibration	Fx,Fy (N)	Fz ³ (N)	Tx,Ty (Nm)	Tz (Nm)	Fx,Fy (N)	Fz ³ (N)	Tx,Ty (Nm)	Tz (Nm)
Mini45	SI-145-5	145	290	5	5	1/16	1/16	1/752	1/1504
Mini45	SI-290-10	290	580	10	10	1/8	1/8	1/376	1/752
Mini45	SI-580-20	580	1160	20	20	1/4	1/4	1/188	1/376
Sensing Ranges						Resolution (DAQ, Net F/T)⁴			

Notes:

1. These system resolutions quoted are the effective resolution after dropping four counts of noise. The effective resolution can be improved with filtering.
2. Applied loads must be within range in each of the six axes for the F/T sensor to measure correctly.
3. For IP68 version see caution on physical properties page.
4. DAQ resolutions are typical for a 16-bit data acquisition system.

5.10.4 CTL Calibration Specifications

Table 5.55— Mini45 CTL Calibrations ^{1, 2}									
Sensor	(US) Standard Calibration	Fx,Fy (lbf)	Fz ³ (lbf)	Tx,Ty (lbf-in)	Tz (lbf-in)	Fx,Fy (lbf)	Fz ³ (lbf)	Tx,Ty (lbf-in)	Tz (lbf-in)
Mini45	US-30-40	30	60	40	40	1/40	1/40	1/44	1/88
Mini45	US-60-80	60	120	80	80	1/20	1/20	1/22	1/44
Mini45	US-120-160	120	240	160	160	1/10	1/10	1/11	1/22
Sensor	(SI) Metric Calibration	Fx,Fy (N)	Fz ³ (N)	Tx,Ty (Nm)	Tz (Nm)	Fx,Fy (N)	Fz ³ (N)	Tx,Ty (Nm)	Tz (Nm)
Mini45	SI-145-5	145	290	5	5	1/8	1/8	1/376	1/752
Mini45	SI-290-10	290	580	10	10	1/4	1/4	1/188	1/376
Mini45	SI-580-20	580	1160	20	20	1/2	1/2	1/94	1/188
Sensing Ranges						Resolution (Controller)			

Notes:

1. CTL resolutions are typical. System resolutions quoted are the effective resolution after dropping eight counts of noise. The effective resolution can be improved with filtering.
2. Applied loads must be within range in each of the six axes for the F/T sensor to measure correctly.
3. For IP68 version see caution on physical properties page.

5.10.5 CTL Analog Output

Table 5.56— Mini45 Analog Output							
Sensor	(US) Standard Calibration	F _x ,F _y (lbf)	F _z ² (lbf)	T _x ,T _y ,T _z (lbf-in)	F _x ,F _y (lbf/V)	F _z ² (lbf/V)	T _x ,T _y ,T _z (lbf-in/V)
Mini45	US-30-40	±30	±60	±40	3	6	4
Mini45	US-60-80	±60	±120	±80	6	12	8
Mini45	US-120-160	±120	±240	±160	12	24	16
Sensor	(SI) Metric Calibration	F _x ,F _y (N)	F _z ² (N)	T _x ,T _y ,T _z (Nm)	F _x ,F _y (N/V)	F _z ² (N/V)	T _x ,T _y ,T _z (Nm/V)
Mini45	SI-145-5	±145	±290	±5	14.5	29	0.5
Mini45	SI-290-10	±290	±580	±10	29	58	1
Mini45	SI-580-20	±580	±1160	±20	58	116	2
Analog Output Range					Analog ±10V Sensitivity¹		

Notes:

- ±5V Sensitivity values are double the listed ±10V Sensitivity values.
- For IP68 version see caution on physical properties page.

5.10.6 CTL Counts Value

Table 5.57—Counts Value					
Sensor	Calibration	F _x , F _y , F _z (/ lbf)	T _x , T _y , T _z (/ lbf-in)	F _x , F _y , F _z (/ N)	T _x , T _y , T _z (/ Nm)
Mini45	US-30-40 / SI-145-5	640	704	128	6016
Mini45	US-60-80 / SI-290-10	320	352	64	3008
Mini45	US-120-160 / SI-580-20	160	176	32	1504
Mini45	Tool Transform Factor	0.009091 in/lbf		0.21277 mm/N	
Counts Value – Standard (US)			Counts Value – Metric (SI)		

5.10.7 Mini45 (US Calibration Complex Loading)(Includes IP65/IP68)¹

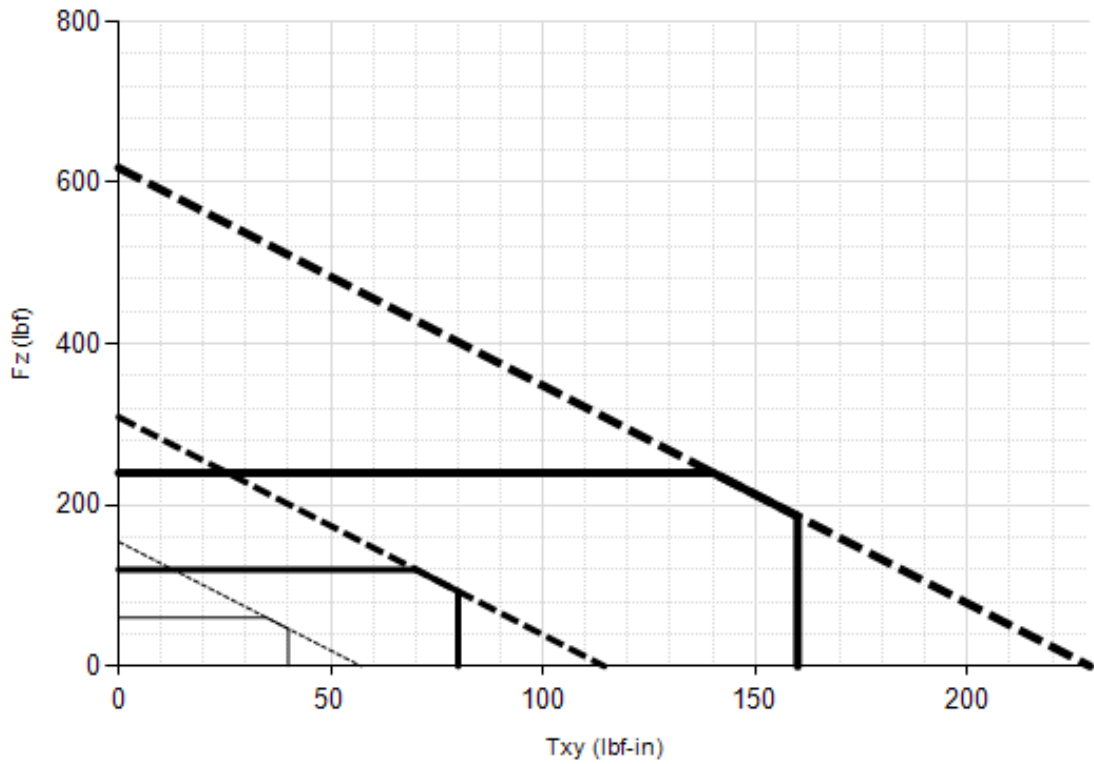
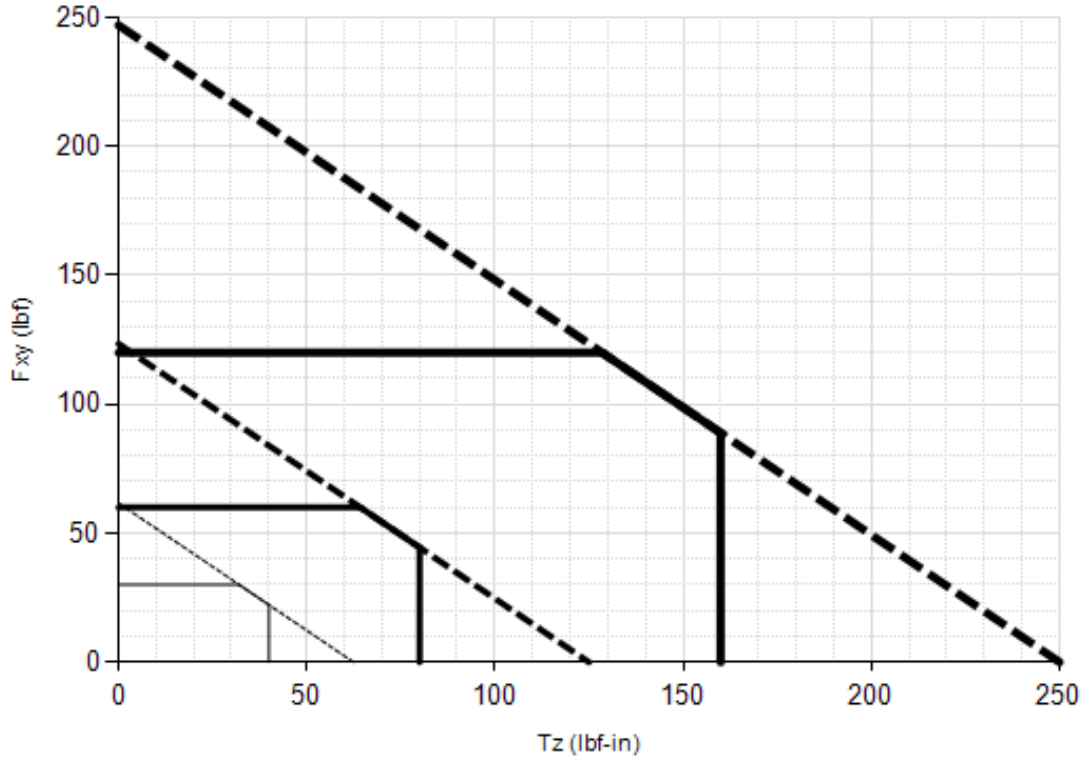

US-30-40
 US-60-80
 US-120-160

Note: 1. For IP68 version see caution on physical properties page.

5.10.8 Mini45 (SI Calibration Complex Loading)(Includes IP65/IP68)¹

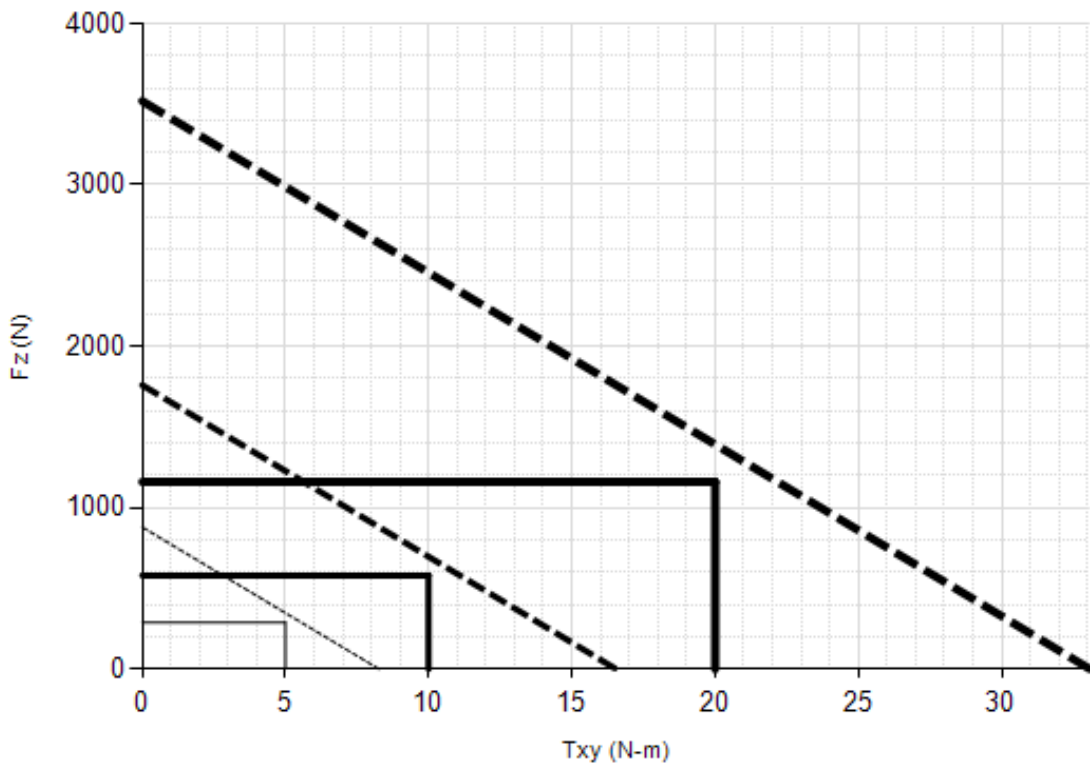
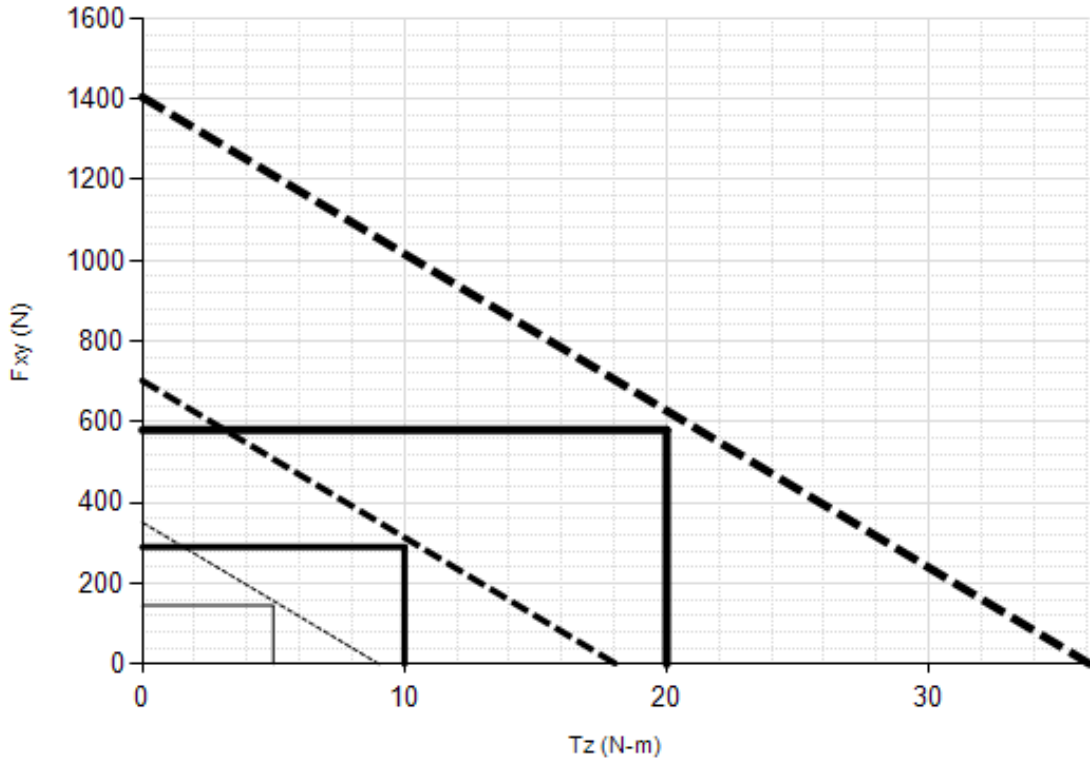

SI-145-5
 SI-290-10
 SI-580-20

Note: 1. For IP68 version see caution on physical properties page.

5.11 Mini58 Specifications (Includes IP60/IP65/IP68 Versions)

In addition to the information in the following sections, refer to the ATI website:

Table 5.58—Mini58 Drawing and Web Links		
Model	Drawing Part Number	ATI Website Address
Mini58	9230-05-1383	https://www.ati-ia.com/products/ft/ft_models.aspx?id=Mini58
Mini58-ERA	9230-05-1522	
Mini58 IP60	9230-05-1437	https://www.ati-ia.com/products/ft/ft_models.aspx?id=Mini58+IP60
Mini58 IP65/IP68	9230-05-1454	https://www.ati-ia.com/products/ft/ft_models.aspx?id=Mini58+IP65%2fIP68

5.11.1 Mini58 Physical Properties

Table 5.59—Mini58 Physical Properties		
Single-Axis Overload	(US) Standard Units	(SI) Metric Units
Fxy	±4800 lbf	±21000 N
Fz	±11000 lbf	±48000 N
Txy	±5300 inf-lb	±590 Nm
Tz	±7100 inf-lb	±800 Nm
Stiffness (Calculated)		
X-axis & Y-axis forces (Kx, Ky)	1.4x10 ⁶ lb/in	2.5x10 ⁸ N/m
Z-axis force (Kz)	2.1x10 ⁶ lb/in	3.7x10 ⁸ N/m
X-axis & Y-axis torque (Ktx, Kty)	9.3x10 ⁵ lbf-in/rad	1.1x10 ⁵ Nm/rad
Z-axis torque (Ktz)	1.8x10 ⁶ lbf-in/rad	2.0x10 ⁵ Nm/rad
Resonant Frequency		
Fx, Fy, Tz	3000 Hz	3000 Hz
Fz, Tx, Ty	5700 Hz	5700 Hz
Physical Specifications		
Weight ¹	0.76 lb	0.345 kg
Diameter ¹	2.28 in	58 mm
Height ¹	1.18 in	30 mm
Note: 1. Specifications include standard interface plates.		

5.11.2 Mini58 IP60 Physical Properties

Table 5.60—Mini58 IP60 Physical Properties		
Single-Axis Overload	(US) Standard Units	(SI) Metric Units
Fxy	±4800 lbf	±21000 N
Fz	±11000 lbf	±48000 N
Txy	±5300 inf-lb	±590 Nm
Tz	±7100 inf-lb	±800 Nm
Stiffness (Calculated)		
X-axis & Y-axis forces (Kx, Ky)	1.4x10 ⁶ lb/in	2.5x10 ⁸ N/m
Z-axis force (Kz)	2.1x10 ⁶ lb/in	3.7x10 ⁸ N/m
X-axis & Y-axis torque (Ktx, Kty)	9.3x10 ⁵ lbf-in/rad	1.1x10 ⁵ Nm/rad
Z-axis torque (Ktz)	1.8x10 ⁶ lbf-in/rad	2.0x10 ⁵ Nm/rad
Resonant Frequency		
Fx, Fy, Tz	N/A	N/A
Fz, Tx, Ty	N/A	N/A
Physical Specifications		
Weight ¹	1.15 lb	0.522 kg
Diameter ¹	3.23 in	82 mm
Height ¹	1.42 in	36.2 mm
Note: 1. Specifications include standard interface plates.		

5.11.3 Mini58 IP65/IP68 Physical Properties

Table 5.61—Mini58 IP65/IP68 Physical Properties		
Single-Axis Overload	(US) Standard Units	(SI) Metric Units
Fxy	±4800 lbf	±21000 N
Fz	±11000 lbf	±48000 N
Txy	±5300 inf-lb	±590 Nm
Tz	±7100 inf-lb	±800 Nm
Stiffness (Calculated)		
X-axis & Y-axis forces (Kx, Ky)	1.4x10 ⁶ lb/in	2.5x10 ⁸ N/m
Z-axis force (Kz)	2.1x10 ⁶ lb/in	3.7x10 ⁸ N/m
X-axis & Y-axis torque (Ktx, Kty)	9.3x10 ⁵ lbf-in/rad	1.1x10 ⁵ Nm/rad
Z-axis torque (Ktz)	1.8x10 ⁶ lbf-in/rad	2.0x10 ⁵ Nm/rad
Resonant Frequency		
Fx, Fy, Tz	N/A	N/A
Fz, Tx, Ty	N/A	N/A
Physical Specifications		
Weight ¹	1.77 lb	0.804 kg
Diameter ¹	2.58 in	65.4 mm
Height ¹	1.48 in	37.6 mm
Note: 1. Specifications include standard interface plates.		



CAUTION: When submerged, IP68 transducers exhibit a decrease in Fz range related to the submersion depth. This loss is the result of pressure-induced preloading on the transducer. The preload can be masked by biasing the transducer at the depth prior to applying the load to be measured. The following estimates are for room temperature fresh water at sea level.

Submersion Depth		
IP68 Mini58	US	Metric
Fz preload at 4 m depth	24.3 lb	108 N
Fz preload at other depths	-1.86 lb/ft x depthInFeet	-27.1 N/m x depthInMeters

5.11.4 Calibration Specifications (excludes CTL calibrations)

Table 5.62— Mini58 Calibrations (excludes CTL calibrations)^{1, 2}

Sensor	(US) Standard Calibration	Fx,Fy (lbf)	Fz ³ (lbf)	Tx,Ty (lbf-in)	Tz (lbf-in)	Fx,Fy (lbf)	Fz ³ (lbf)	Tx,Ty (lbf-in)	Tz (lbf-in)
Mini58	US-150-250	150	375	250	250	5/112	1/16	1/20	7/240
Mini58	US-300-500	300	750	500	500	5/56	1/8	1/10	7/120
Mini58	US-600-1000	600	1500	1000	1000	5/28	1/4	1/5	7/60
Sensor	(SI) Metric Calibration	Fx,Fy (N)	Fz ³ (N)	Tx,Ty (Nm)	Tz (Nm)	Fx,Fy (N)	Fz ³ (N)	Tx,Ty (Nm)	Tz (Nm)
Mini58	SI-700-30	700	1700	30	30	1/6	7/24	9/1600	1/320
Mini58	SI-1400-60	1400	3400	60	60	1/3	7/12	9/800	1/160
Mini58	SI-2800-120	2800	6800	120	120	3/4	1 1/4	9/400	1/80
					Sensing Ranges	Resolution (DAQ, Net F/T) ⁴			

Notes:

1. These system resolutions quoted are the effective resolution after dropping four counts of noise. The effective resolution can be improved with filtering.
2. Applied loads must be within range in each of the six axes for the F/T sensor to measure correctly.
3. For IP68 version see caution on physical properties page.
4. DAQ resolutions are typical for a 16-bit data acquisition system.

5.11.5 CTL Calibration Specifications

Table 5.63— Mini58 CTL Calibrations ^{1, 2}										
Sensor	(US) Standard Calibration	Fx,Fy (lbf)	Fz ³ (lbf)	Tx,Ty (lbf-in)	Tz (lbf-in)	Fx,Fy (lbf)	Fz ³ (lbf)	Tx,Ty (lbf-in)	Tz (lbf-in)	
Mini58	US-150-250	150	375	250	250	5/56	1/8	1/10	7/120	
Mini58	US-300-500	300	750	500	500	5/28	1/4	1/5	7/60	
Mini58	US-600-1000	600	1500	1000	1000	5/14	1/2	2/5	7/30	
Sensor	(SI) Metric Calibration	Fx,Fy (N)	Fz ³ (N)	Tx,Ty (Nm)	Tz (Nm)	Fx,Fy (N)	Fz ³ (N)	Tx,Ty (Nm)	Tz (Nm)	
Mini58	SI-700-30	700	1700	30	30	1/3	7/12	9/800	1/160	
Mini58	SI-1400-60	1400	3400	60	60	2/3	1 1/6	9/400	1/80	
Mini58	SI-2800-120	2800	6800	120	120	1 1/2	2 1/2	9/200	1/40	
					Sensing Ranges			Resolution (Controller)		

Notes:

1. CTL resolutions are typical. System resolutions quoted are the effective resolution after dropping eight counts of noise. The effective resolution can be improved with filtering.
2. Applied loads must be within range in each of the six axes for the F/T sensor to measure correctly.
3. For IP68 version see caution on physical properties page.

5.11.6 CTL Analog Output

Table 5.64— Mini58 Analog Output							
Sensor	(US) Standard Calibration	Fx,Fy (lbf)	Fz ² (lbf)	Tx,Ty,Tz (lbf-in)	Fx,Fy (lbf/V)	Fz ² (lbf/V)	Tx,Ty,Tz (lbf-in/V)
Mini58	US-150-250	±150	±375	±250	15	37.5	25
Mini58	US-300-500	±300	±750	±500	30	75	50
Mini58	US-600-1000	±600	±1500	±1000	60	150	100
Sensor	(SI) Metric Calibration	Fx,Fy (N)	Fz ² (N)	Tx,Ty,Tz (Nm)	Fx,Fy (N/V)	Fz ² (N/V)	Tx,Ty,Tz (Nm/V)
Mini58	SI-700-30	±700	±1700	±30	70	170	3
Mini58	SI-1400-60	±1400	±3400	±60	140	340	6
Mini58	SI-2800-120	±2800	±6800	±120	280	680	12
				Analog Output Range		Analog ±10V Sensitivity ¹	

Notes:

1. ±5V Sensitivity values are double the listed ±10V Sensitivity values.
2. For IP68 version see caution on physical properties page.

5.11.7 CTL Counts Value

Table 5.65—Counts Value					
Sensor	Calibration	F _x , F _y , F _z (/ lbf)	T _x , T _y , T _z (/ lbf-in)	F _x , F _y , F _z (/ N)	T _x , T _y , T _z (/ Nm)
Mini58	US-150-250 / SI-700-30	448	960	96	6400
Mini58	US-300-500 / SI-1400-60	224	480	48	3200
Mini58	US-600-1000 / SI-2800-120	112	240	16	1600
Mini58	Tool Transform Factor	See Tool Transform Factor table			
		Counts Value – Standard (US)		Counts Value – Metric (SI)	

5.11.8 Tool Transform Factor

Table 5.66—Tool Transform Factor			
Sensor	Calibration	US (English)	SI (Metric)
Mini58	US-150-250 / SI-700-30	0.00467 in/lbf	0.150 mm/N
Mini58	US-300-500 / SI-1400-60	0.00467 in/lbf	0.150 mm/N
Mini58	US-600-1000 / SI-2800-120	0.00467 in/lbf	0.150 mm/N

5.11.9 Mini58 (US Calibration Complex Loading)(Includes IP60/IP65/IP68)¹

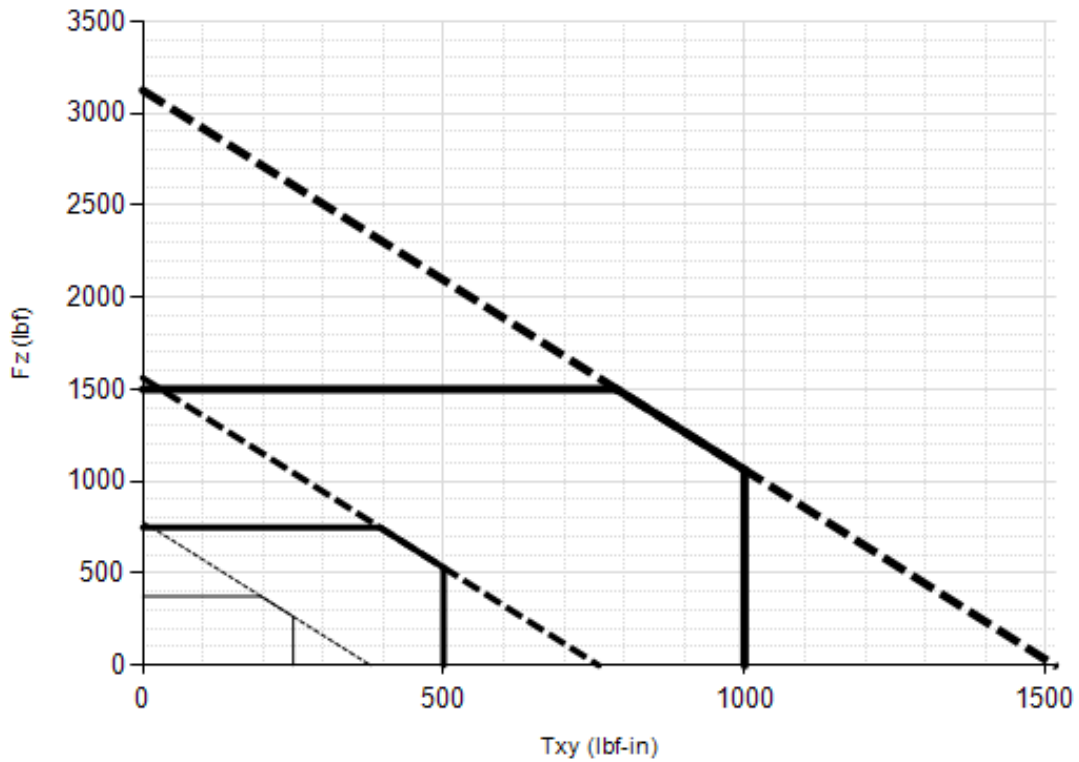
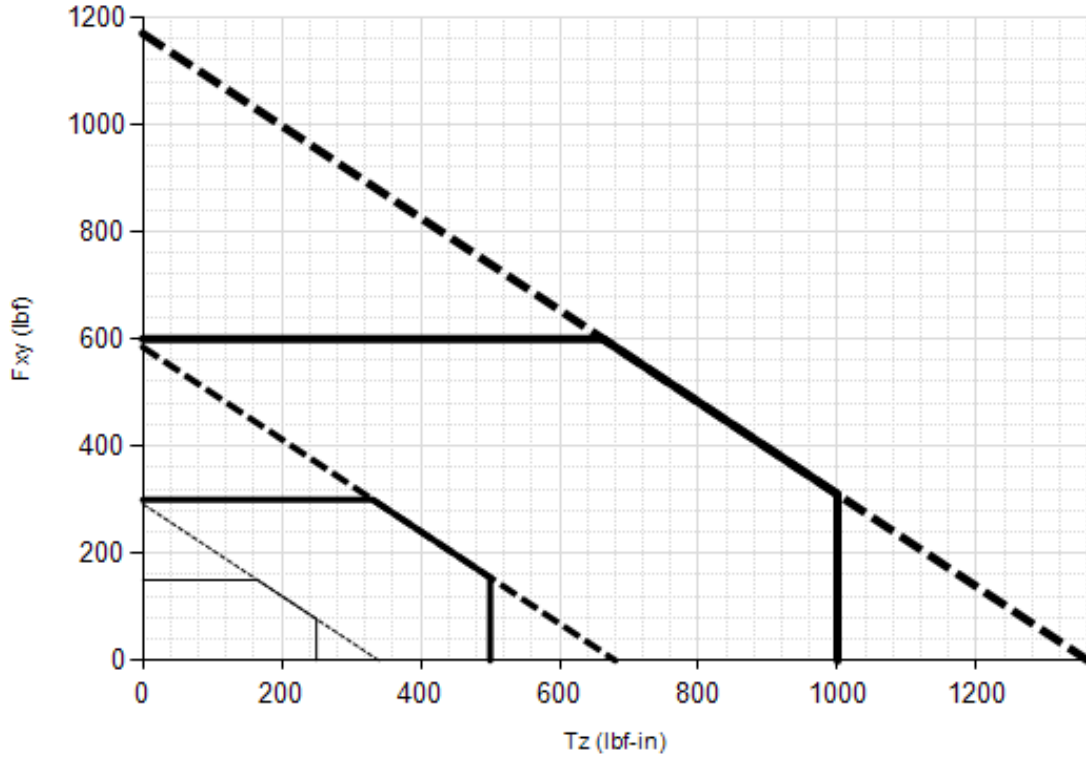

US-150-250
 US-300-500
 US-600-1000

Note: 1. For IP68 version see caution on physical properties page.

5.11.10 Mini58 (SI Calibration Complex Loading)(Includes IP60/IP65/IP68)¹

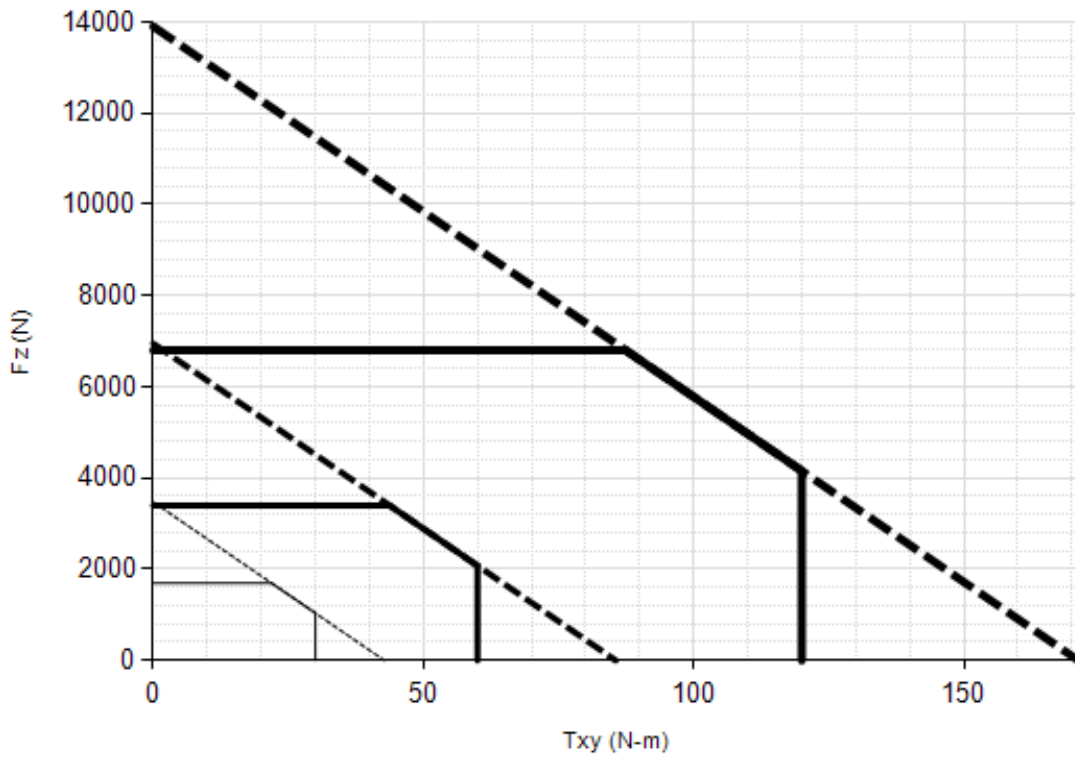
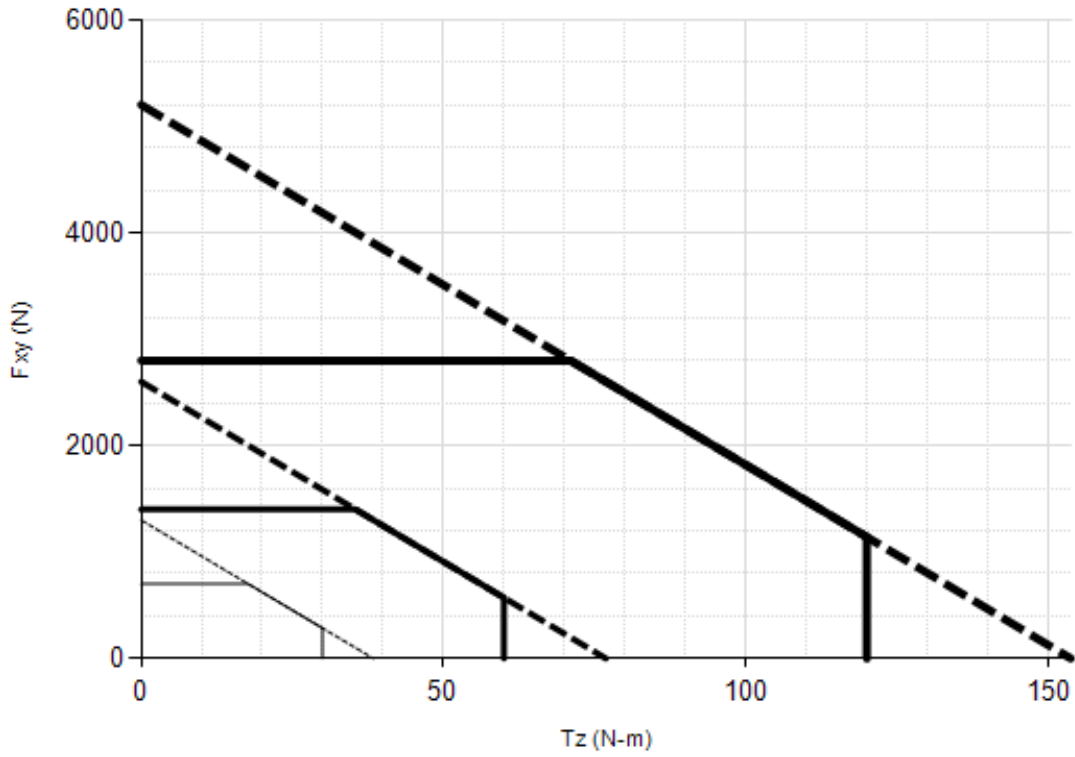

SI-700-30
 SI-1400-60
 SI-2800-120

Note: 1. For IP68 version see caution on physical properties page.

5.12 Mini85 Specifications

In addition to the information in the following sections, refer to the ATI website:

Model	Drawing Part Number	ATI Website Address
Mini85	9230-05-1383	https://www.ati-ia.com/products/ft/ft_models.aspx?id=Mini85
Mini85 with 20 mm through hole	9230-05-1323	

5.12.1 Mini85 Physical Properties

Single-Axis Overload	(US) Standard Units	(SI) Metric Units
Fxy	±2800 lbf	±13000 N
Fz	±6100 lbf	±27000 N
Txy	±4400 inf-lb	±500 Nm
Tz	±5400 inf-lb	±610 Nm
Stiffness (Calculated)		
X-axis & Y-axis forces (Kx, Ky)	4.4x10 ⁵ lb/in	7.7x10 ⁷ N/m
Z-axis force (Kz)	6.8x10 ⁵ lb/in	1.2x10 ⁸ N/m
X-axis & Y-axis torque (Ktx, Kty)	7.2x10 ⁵ lbf-in/rad	8.1x10 ⁴ Nm/rad
Z-axis torque (Ktz)	1.2x10 ⁶ lbf-in/rad	1.3x10 ⁵ Nm/rad
Resonant Frequency		
Fx, Fy, Tz	2400 Hz	2400 Hz
Fz, Tx, Ty	3100 Hz	3100 Hz
Physical Specifications		
Weight ¹	1.4 lb	0.635 kg
Diameter ¹	3.35 in	85.1 mm
Height ¹	1.17 in	29.8 mm
Note: 1. Specifications include standard interface plates.		

5.12.2 Calibration Specifications (excludes CTL calibrations)

Table 5.69— Mini85 Calibrations (excludes CTL calibrations) ^{1, 2}									
Sensor	(US) Standard Calibration	Fx,Fy (lbf)	Fz (lbf)	Tx,Ty (lbf-in)	Tz (lbf-in)	Fx,Fy (lbf)	Fz (lbf)	Tx,Ty (lbf-in)	Tz (lbf-in)
Mini85	US-105-185	105	210	185	185	1/52	7/260	5/168	1/48
Mini85	US-210-370	210	420	370	370	5/128	3/64	5/84	1/24
Mini85	US-420-740	420	840	740	740	5/64	3/32	5/42	1/12
Sensor	(SI) Metric Calibration	Fx,Fy (N)	Fz (N)	Tx,Ty (Nm)	Tz (Nm)	Fx,Fy (N)	Fz (N)	Tx,Ty (Nm)	Tz (Nm)
Mini85	SI-475-20	475	950	20	20	9/112	3/28	5/1496	7/2992
Mini85	SI-950-40	950	1900	40	40	9/56	3/14	5/748	7/1496
Mini85	SI-1900-80	1900	3800	80	80	9/28	3/7	5/374	7/748
		Sensing Ranges				Resolution (DAQ, Net F/T)³			

Notes:

1. These system resolutions quoted are the effective resolution after dropping four counts of noise. The effective resolution can be improved with filtering.
2. Applied loads must be within range in each of the six axes for the F/T sensor to measure correctly.
3. DAQ resolutions are typical for a 16-bit data acquisition system.

5.12.3 CTL Calibration Specifications

Table 5.70— Mini85 CTL Calibrations ^{1, 2}									
Sensor	(US) Standard Calibration	Fx,Fy (lbf)	Fz (lbf)	Tx,Ty (lbf-in)	Tz (lbf-in)	Fx,Fy (lbf)	Fz (lbf)	Tx,Ty (lbf-in)	Tz (lbf-in)
Mini85	US-105-185	105	210	185	185	1/26	7/130	5/84	1/24
Mini85	US-210-370	210	420	370	370	5/64	3/32	5/42	1/12
Mini85	US-420-740	420	840	740	740	5/32	3/16	5/21	1/6
Sensor	(SI) Metric Calibration	Fx,Fy (N)	Fz (N)	Tx,Ty (Nm)	Tz (Nm)	Fx,Fy (N)	Fz (N)	Tx,Ty (Nm)	Tz (Nm)
Mini85	SI-475-20	475	950	20	20	9/56	3/14	5/748	7/1496
Mini85	SI-950-40	950	1900	40	40	9/28	3/7	5/374	7/748
Mini85	SI-1900-80	1900	3800	80	80	9/14	6/7	5/187	7/374
		Sensing Ranges				Resolution (Controller)			

Notes:

1. CTL resolutions are typical. System resolutions quoted are the effective resolution after dropping eight counts of noise. The effective resolution can be improved with filtering.
2. Applied loads must be within range in each of the six axes for the F/T sensor to measure correctly.

5.12.4 CTL Analog Output

Table 5.71— Mini85 Analog Output							
Sensor	(US) Standard Calibration	Fx,Fy (lbf)	Fz (lbf)	Tx,Ty,Tz (lbf-in)	Fx,Fy (lbf/V)	Fz (lbf/V)	Tx,Ty,Tz (lbf-in/V)
Mini85	US-105-185	±105	±210	±185	10.5	21	18.5
Mini85	US-210-370	±210	±420	±370	21	42	37
Mini85	US-420-740	±420	±840	±740	42	84	74
Sensor	(SI) Metric Calibration	Fx,Fy (N)	Fz (N)	Tx,Ty,Tz (Nm)	Fx,Fy (N/V)	Fz (N/V)	Tx,Ty,Tz (Nm/V)
Mini85	SI-475-20	±475	±950	±20	47.5	95	2
Mini85	SI-950-40	±950	±1900	±40	95	190	4
Mini85	SI-1900-80	±1900	±3800	±80	190	380	8
		Analog Output Range			Analog ±10V Sensitivity¹		
Notes:							
1. ±5V Sensitivity values are double the listed ±10V Sensitivity values.							

5.12.5 CTL Counts Value

Table 5.72—Counts Value					
Sensor	Calibration	Fx, Fy, Fz (/ lbf)	Tx, Ty, Tz (/ lbf-in)	Fx, Fy, Fz (/ N)	Tx, Ty, Tz (/ Nm)
Mini85	US-105-185 / SI-475-20	1040	1344	448	11968
Mini85	US-210-370 / SI-950-40	512	672	224	5984
Mini85	US-420-740 / SI-1900-80	256	336	112	2992
Mini85	Tool Transform Factor	See Tool Transform Factor table			
		Counts Value – Standard (US)		Counts Value – Metric (SI)	

5.12.6 Tool Transform Factor

Table 5.73—Tool Transform Factor			
Sensor	Calibration	US (English)	SI (Metric)
Mini85	US-105-185 / SI-475-20	0.00774 in/lbf	0.374 mm/N
Mini85	US-210-370 / SI-950-40	0.00762 in/lbf	0.374 mm/N
Mini85	US-420-740 / SI-1900-80	0.00762 in/lbf	0.374 mm/N

5.12.7 Mini85 (US Calibration Complex Loading)(Includes IP60)

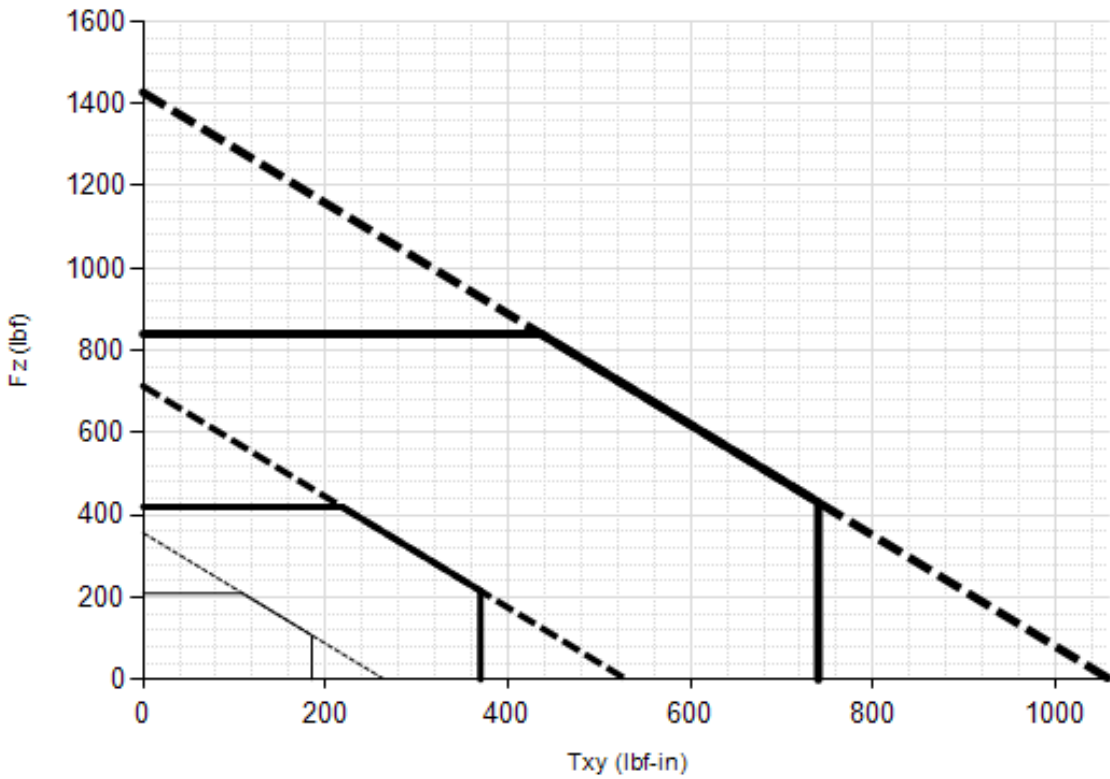
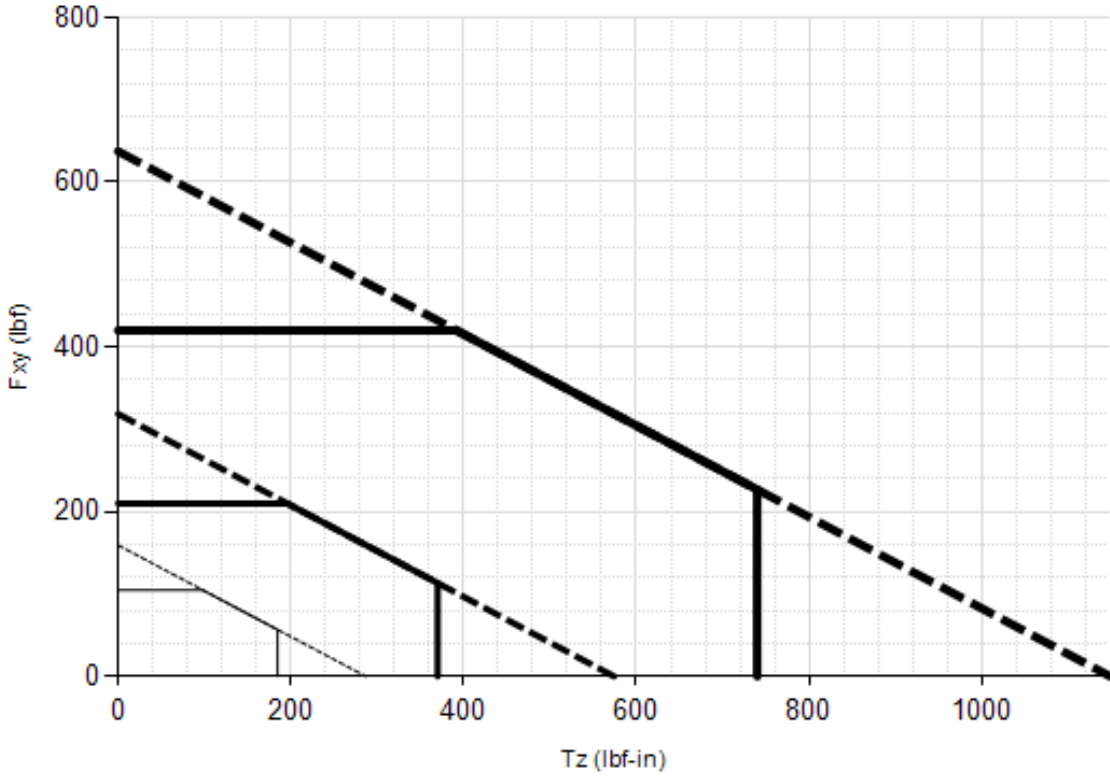

US-105-185
 US-210-370
 US-420-740

5.12.8 Mini85 (SI Calibration Complex Loading)(Includes IP60)

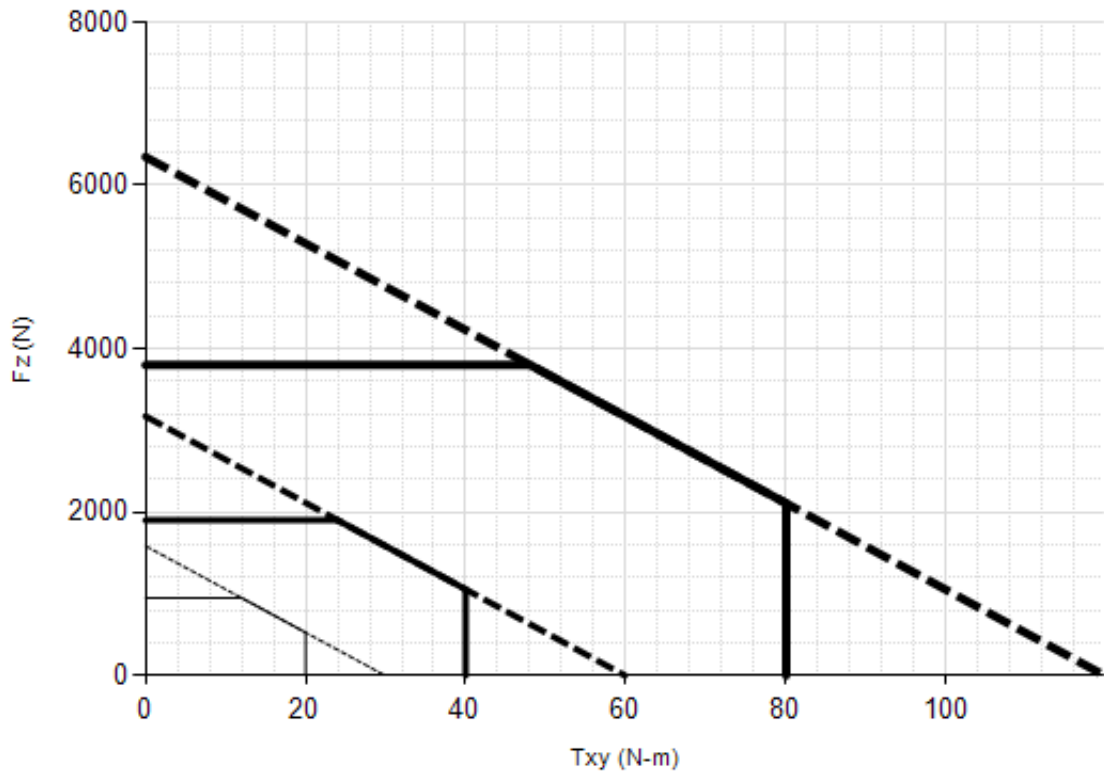
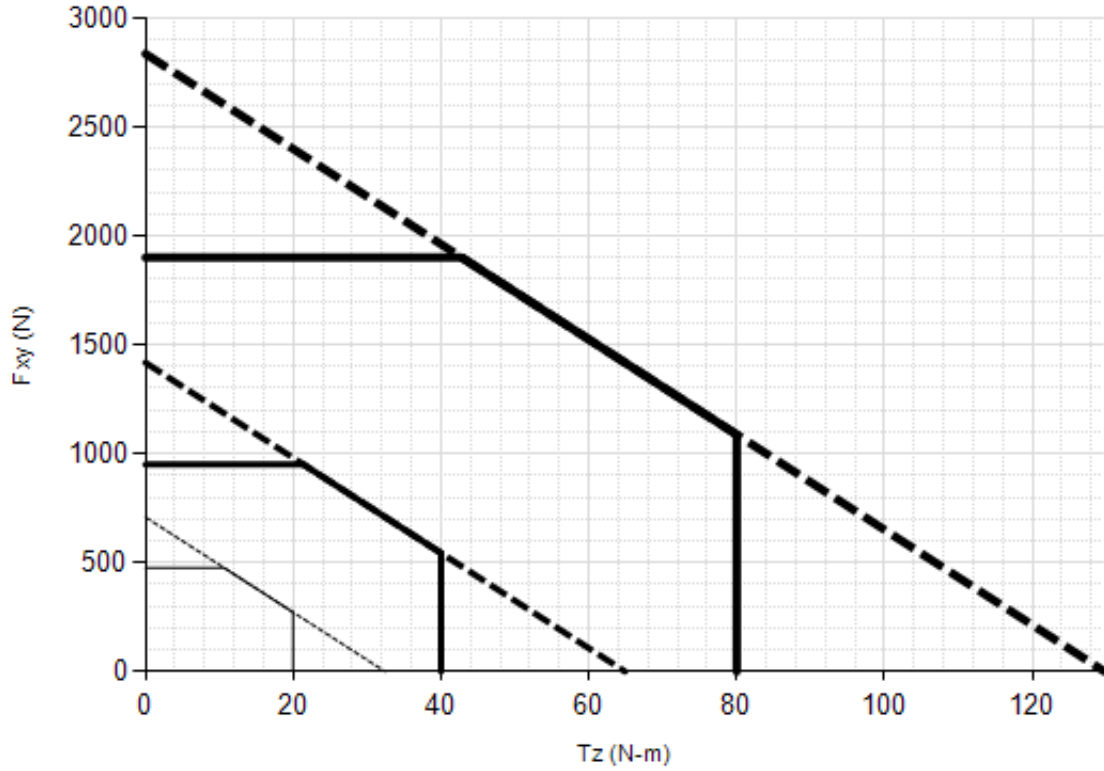

SI-475-20
 SI-950-40
 SI-1900-80

5.13 Gamma Specifications (Includes IP60/IP65/IP68 Versions)

In addition to the information in the following sections, refer to the ATI website:

Table 5.74—Gamma Drawing and Web Links		
Model	Drawing Part Number	ATI Website Address
Gamma Mux ¹ transducer without standard mounting adapter	9230-05-1103	https://www.ati-ia.com/products/ft/ft_models.aspx?id=Gamma
Gamma DAQ/NET transducer with mounting adapter plate	9230-05-1329	
Gamma adapter mounting plate (non-IP rated)	9230-05-1057	
Gamma IP60	9230-05-1335	https://www.ati-ia.com/products/ft/ft_models.aspx?id=Gamma+IP60
Gamma IP65	9230-05-1307	https://www.ati-ia.com/products/ft/ft_models.aspx?id=Gamma+IP65
Gamma IP65 ECAT	9230-05-1508	
Gamma IP68	9230-05-1386	https://www.ati-ia.com/products/ft/ft_models.aspx?id=Gamma+IP68
Note:		
1. Mux transducers are used in F/T Controller systems.		

5.13.1 Gamma Physical Properties

Table 5.75—Gamma Physical Properties		
Single-Axis Overload	(US) Standard Units	(SI) Metric Units
Fxy	±280 lbf	±1200 N
Fz	±930 lbf	±4100 N
Txy	±700 inf-lb	±79 Nm
Tz	±730 inf-lb	±82 Nm
Stiffness (Calculated)		
X-axis & Y-axis forces (Kx, Ky)	5.2x10 ⁴ lb/in	9.1x10 ⁶ N/m
Z-axis force (Kz)	1.0x10 ⁵ lb/in	1.8x10 ⁷ N/m
X-axis & Y-axis torque (Ktx, Kty)	9.3x10 ⁴ lbf-in/rad	1.1x10 ⁴ Nm/rad
Z-axis torque (Ktz)	1.4x10 ⁵ lbf-in/rad	1.6x10 ⁴ Nm/rad
Resonant Frequency		
Fx, Fy, Tz	1400 Hz	1400 Hz
Fz, Tx, Ty	2000 Hz	2000 Hz
Physical Specifications		
Weight ¹	0.562 lb	0.255 kg
Diameter ¹	2.97 in	75.4 mm
Height ¹	1.31 in	33.3 mm
Note:		
1. Specifications include standard interface plates.		

5.13.2 Gamma IP60 Physical Properties

Table 5.76—Gamma IP60 Physical Properties		
Single-Axis Overload	(US) Standard Units	(SI) Metric Units
Fxy	±280 lbf	±1200 N
Fz	±930 lbf	±4100 N
Txy	±700 inf-lb	±79 Nm
Tz	±730 inf-lb	±82 Nm
Stiffness (Calculated)		
X-axis & Y-axis forces (Kx, Ky)	5.2x10 ⁴ lb/in	9.1x10 ⁶ N/m
Z-axis force (Kz)	1.0x10 ⁵ lb/in	1.8x10 ⁷ N/m
X-axis & Y-axis torque (Ktx, Kty)	9.3x10 ⁴ lbf-in/rad	1.1x10 ⁴ Nm/rad
Z-axis torque (Ktz)	1.4x10 ⁵ lbf-in/rad	1.6x10 ⁴ Nm/rad
Resonant Frequency		
Fx, Fy, Tz	1200 Hz	1200 Hz
Fz, Tx, Ty	1200 Hz	1200 Hz
Physical Specifications		
Weight ¹	1.03 lb	0.467 kg
Diameter ¹	3.9 in	99.1 mm
Height ¹	1.56 in	39.6 mm
Note: 1. Specifications include standard interface plates.		

5.13.3 Gamma IP65 Physical Properties

Table 5.77—Gamma IP65 Physical Properties		
Single-Axis Overload	(US) Standard Units	(SI) Metric Units
Fxy	±280 lbf	±1200 N
Fz	±930 lbf	±4100 N
Txy	±700 inf-lb	±79 Nm
Tz	±730 inf-lb	±82 Nm
Stiffness (Calculated)		
X-axis & Y-axis forces (Kx, Ky)	5.2x10 ⁴ lb/in	9.1x10 ⁶ N/m
Z-axis force (Kz)	1.0x10 ⁵ lb/in	1.8x10 ⁷ N/m
X-axis & Y-axis torque (Ktx, Kty)	9.3x10 ⁴ lbf-in/rad	1.1x10 ⁴ Nm/rad
Z-axis torque (Ktz)	1.4x10 ⁵ lbf-in/rad	1.6x10 ⁴ Nm/rad
Resonant Frequency		
Fx, Fy, Tz	1000 Hz	1000 Hz
Fz, Tx, Ty	970 Hz	970 Hz
Physical Specifications		
Weight ¹	2.4 lb	1.09 kg
Diameter ¹	4.37 in	111 mm
Height ¹	2.06 in	52.3 mm
Note: 1. Specifications include standard interface plates.		

5.13.4 Gamma IP68 Physical Properties

Table 5.78—Gamma IP68 Physical Properties		
Single-Axis Overload	(US) Standard Units	(SI) Metric Units
Fxy	±280 lbf	±1200 N
Fz	±930 lbf	±4100 N
Txy	±700 inf-lb	±79 Nm
Tz	±730 inf-lb	±82 Nm
Stiffness (Calculated)		
X-axis & Y-axis forces (Kx, Ky)	5.2x10 ⁴ lb/in	9.1x10 ⁶ N/m
Z-axis force (Kz)	1.0x10 ⁵ lb/in	1.8x10 ⁷ N/m
X-axis & Y-axis torque (Ktx, Kty)	9.3x10 ⁴ lbf-in/rad	1.1x10 ⁴ Nm/rad
Z-axis torque (Ktz)	1.4x10 ⁵ lbf-in/rad	1.6x10 ⁴ Nm/rad
Resonant Frequency		
Fx, Fy, Tz	1250 Hz	1250 Hz
Fz, Tx, Ty	940 Hz	940 Hz
Physical Specifications		
Weight ¹	4.37 lb	1.98 kg
Diameter ¹	4.37 in	111 mm
Height ¹	2.06 in	52.3 mm
Note: 1. Specifications include standard interface plates.		



CAUTION: When submerged, IP68 transducers exhibit a decrease in Fz range related to the submersion depth. This loss is the result of pressure-induced preloading on the transducer. The preload can be masked by biasing the transducer at the depth prior to applying the load to be measured. The following estimates are for room temperature fresh water at sea level.

Submersion Depth		
IP68 Gamma	US	Metric
Fz preload at 4 m depth	-42.9 lb	-191 N
Fz preload at other depths	-3.27 lb/ft x depthInFeet	-47.4 N/m x depthInMeters

5.13.5 Calibration Specifications (excludes CTL calibrations)

Table 5.79— Gamma Calibrations (excludes CTL calibrations) ^{1,2}									
Sensor	(US) Standard Calibration	Fx,Fy (lbf)	Fz ³ (lbf)	Tx,Ty (lbf-in)	Tz (lbf-in)	Fx,Fy (lbf)	Fz ³ (lbf)	Tx,Ty (lbf-in)	Tz (lbf-in)
Gamma	US-7.5-25	7.5	25	25	25	1/640	1/320	1/320	1/320
Gamma	US-15-50	15	50	50	50	1/320	1/160	1/160	1/160
Gamma	US-30-100	30	100	100	100	1/160	1/80	1/80	1/80
Sensor	(SI) Metric Calibration	Fx,Fy (N)	Fz ³ (N)	Tx,Ty (Nm)	Tz (Nm)	Fx,Fy (N)	Fz ³ (N)	Tx,Ty (Nm)	Tz (Nm)
Gamma	SI-32-2.5	32	100	2.5	2.5	1/160	1/80	1/2000	1/2000
Gamma	SI-65-5	65	200	5	5	1/80	1/40	10/13333	10/13333
Gamma	SI-130-10	130	400	10	10	1/40	1/20	1/800	1/800
Sensing Ranges						Resolution (DAQ, Net F/T)⁴			

Notes:

- These system resolutions quoted are the effective resolution after dropping four counts of noise. The effective resolution can be improved with filtering.
- Applied loads must be within range in each of the six axes for the F/T sensor to measure correctly.
- For IP68 version see caution on physical properties page.
- DAQ resolutions are typical for a 16-bit data acquisition system.

5.13.6 CTL Calibration Specifications

Table 5.80— Gamma CTL Calibrations ^{1,2}									
Sensor	(US) Standard Calibration	Fx,Fy (lbf)	Fz ³ (lbf)	Tx,Ty (lbf-in)	Tz (lbf-in)	Fx,Fy (lbf)	Fz ³ (lbf)	Tx,Ty (lbf-in)	Tz (lbf-in)
Gamma	US-7.5-25	7.5	25	25	25	1/320	1/160	1/160	1/160
Gamma	US-15-50	15	50	50	50	1/160	1/80	1/80	1/80
Gamma	US-30-100	30	100	100	100	1/80	1/40	1/40	1/40
Sensor	(SI) Metric Calibration	Fx,Fy (N)	Fz ³ (N)	Tx,Ty (Nm)	Tz (Nm)	Fx,Fy (N)	Fz ³ (N)	Tx,Ty (Nm)	Tz (Nm)
Gamma	SI-32-2.5	32	100	2.5	2.5	1/80	1/40	1/1000	1/1000
Gamma	SI-65-5	65	200	5	5	1/40	1/20	5/3333	5/3333
Gamma	SI-130-10	130	400	10	10	1/20	1/10	1/400	1/400
Sensing Ranges						Resolution (Controller)			

Notes:

- CTL resolutions are typical. System resolutions quoted are the effective resolution after dropping eight counts of noise. The effective resolution can be improved with filtering.
- Applied loads must be within range in each of the six axes for the F/T sensor to measure correctly.
- For IP68 version see caution on physical properties page.

5.13.7 CTL Analog Output

Table 5.81— Gamma Analog Output							
Sensor	(US) Standard Calibration	F _x ,F _y (lbf)	F _z ² (lbf)	T _x ,T _y ,T _z (lbf-in)	F _x ,F _y (lbf/V)	F _z ² (lbf/V)	T _x ,T _y ,T _z (lbf-in/V)
Gamma	US-7.5-25	±7.5	±25	±25	0.75	2.5	2.5
Gamma	US-15-50	±15	±50	±50	1.5	5	5
Gamma	US-30-100	±30	±100	±100	3	10	10
Sensor	(SI) Metric Calibration	F _x ,F _y (N)	F _z ² (N)	T _x ,T _y ,T _z (Nm)	F _x ,F _y (N/V)	F _z ² (N/V)	T _x ,T _y ,T _z (Nm/V)
Gamma	SI-32-2.5	±32	±100	±2.5	3.2	10	0.25
Gamma	SI-65-5	±65	±200	±5	6.5	20	0.5
Gamma	SI-130-10	±130	±400	±10	13	40	1
Analog Output Range					Analog ±10V Sensitivity¹		

Notes:

- ±5V Sensitivity values are double the listed ±10V Sensitivity values.
- For IP68 version see caution on physical properties page.

5.13.8 CTL Counts Value

Table 5.82—Counts Value					
Sensor	Calibration	Fx, Fy, Fz (/ lbf)	Tx, Ty, Tz (/ lbf-in)	Fx, Fy, Fz (/ N)	Tx, Ty, Tz (/ Nm)
Gamma	US-7.5–25 / SI-32–2.5	2560	2560	640	8000
Gamma	US-15–50 / SI-65–5	1280	1280	320	5333.33
Gamma	US-30–100 / SI-130–10	640	640	160	3200
Gamma	Tool Transform Factor	See Tool Transform Factor table			
		Counts Value – Standard (US)		Counts Value – Metric (SI)	

5.13.9 Tool Transform Factor

Table 5.83—Tool Transform Factor			
Sensor	Calibration	US (English)	SI (Metric)
Gamma	US-7.5–25 / SI-32–2.5	0.01 in/lbf	0.8 mm/N
Gamma	US-15–50 / SI-65–5	0.01 in/lbf	0.6 mm/N
Gamma	US-30–100 / SI-130–10	0.01 in/lbf	0.5 mm/N

**5.13.10 Gamma (US Calibration Complex Loading)
 (Includes IP60/IP65/IP68)¹**

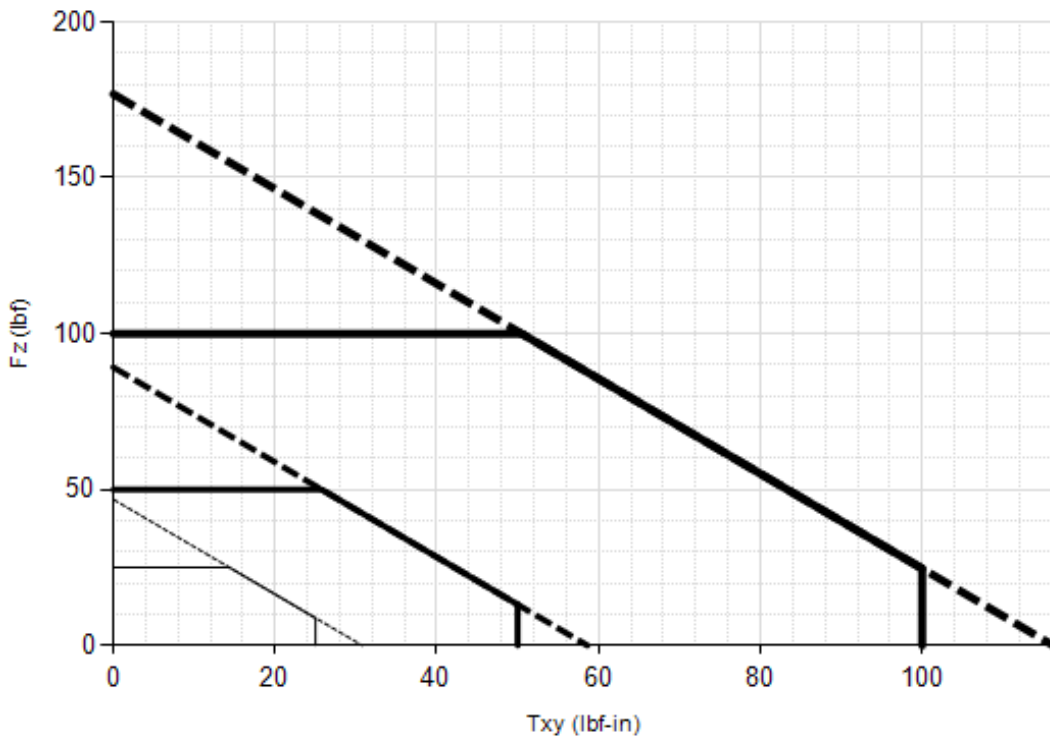
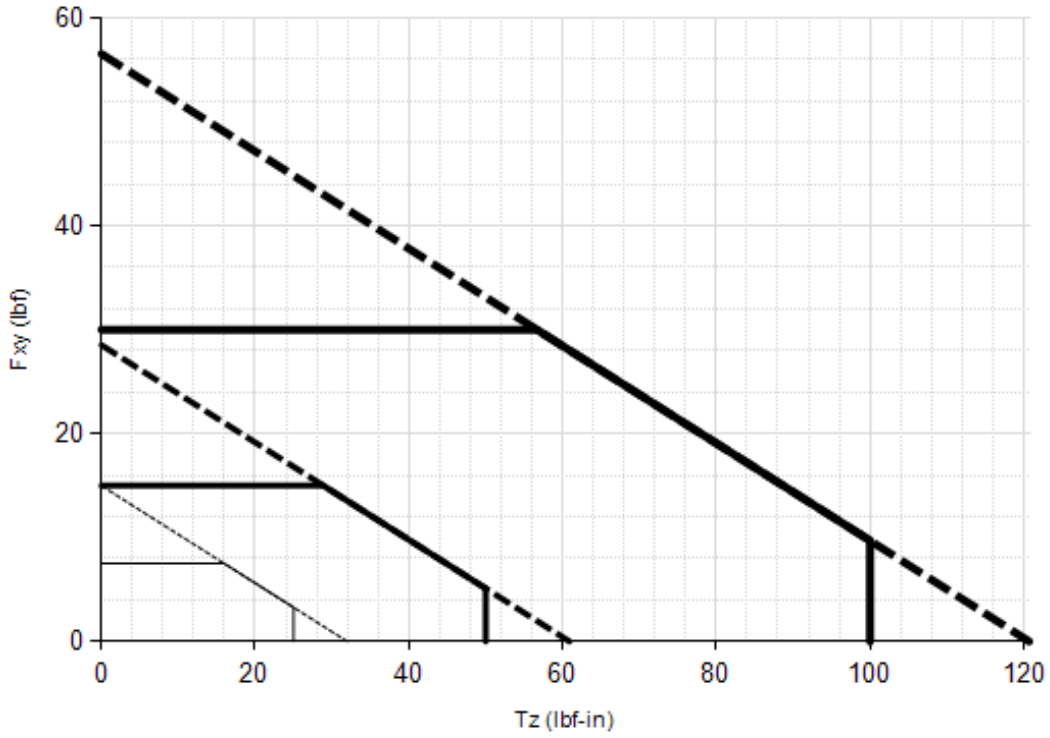

US-7.5-25
 US-15-50
 US-30-100

Note: 1. For IP68 version see caution on physical properties page.

**5.13.11 Gamma (SI Calibration Complex Loading)
 (Includes IP60/IP65/IP68)¹**

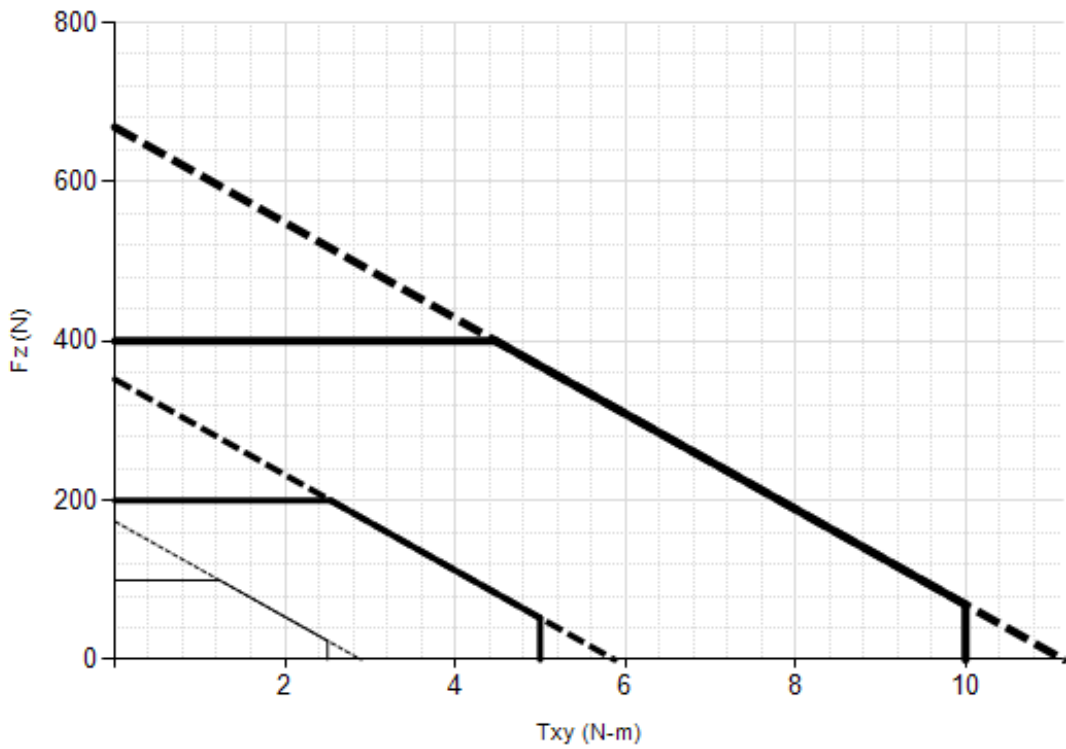
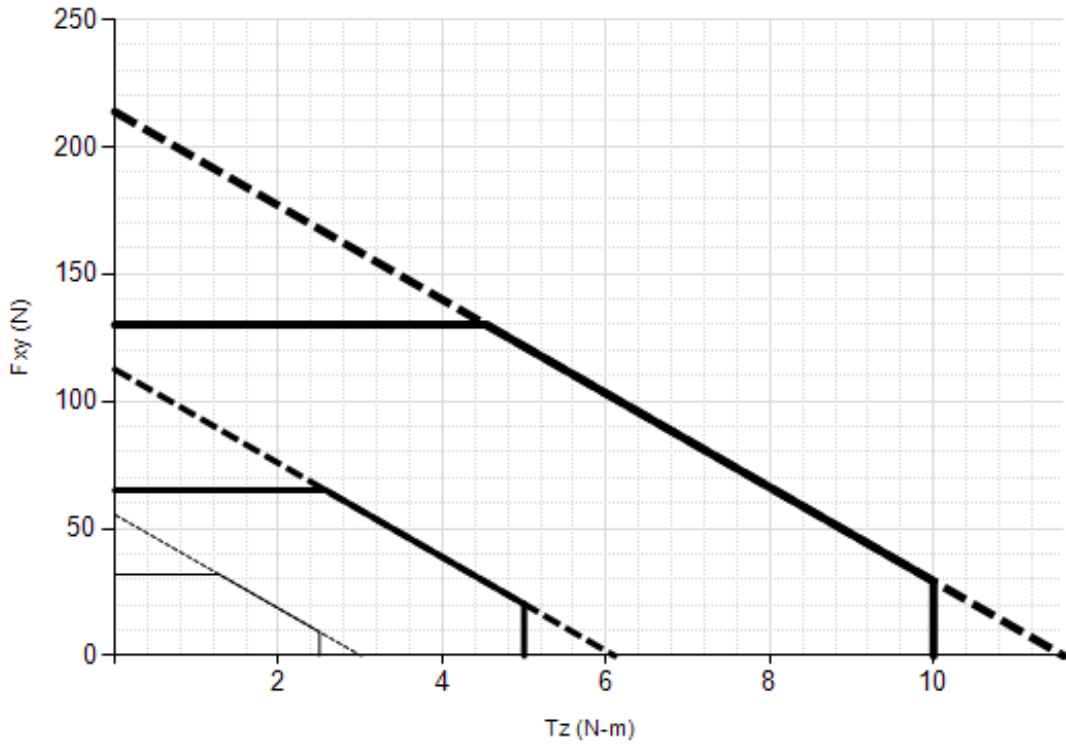

SI-32-2.5
 SI-65-5
 SI-130-10

Note: 1. For IP68 version see caution on physical properties page.

5.14 Delta Specifications (Includes IP60/IP65/IP68 Versions)

In addition to the information in the following sections, refer to the ATI website:

Table 5.84—Delta Drawing and Web Links		
Model	Drawing Part Number	ATI Website Address
Delta Mux ¹ transducer without standard mounting adapter	9230-05-1102	https://www.ati-ia.com/products/ft/ft_models.aspx?id=Delta
Delta DAQ/NET transducer with mounting adapter plate	9230-05-1330	
Delta adapter mounting plate (non-IP rated)	9230-05-1063	
Delta IP60	9230-05-1262	https://www.ati-ia.com/products/ft/ft_models.aspx?id=Delta+IP60
Delta IP60 ECAT	9230-05-1510	
Delta IP65	9230-05-1267	https://www.ati-ia.com/products/ft/ft_models.aspx?id=Delta+IP65
Delta IP65 ECAT	9230-05-1469	
Delta IP68	9230-05-1272	https://www.ati-ia.com/products/ft/ft_models.aspx?id=Delta+IP68
Note:		
1. Mux transducers are used in F/T Controller systems.		

5.14.1 Delta Physical Properties

Table 5.85—Delta Physical Properties		
Single-Axis Overload	(US) Standard Units	(SI) Metric Units
F _{xy}	±840 lbf	±3700 N
F _z	±2300 lbf	±10000 N
T _{xy}	±2500 inf-lb	±280 Nm
T _z	±3600 inf-lb	±400 Nm
Stiffness (Calculated)		
X-axis & Y-axis forces (K _x , K _y)	2.0x10 ⁵ lb/in	3.6x10 ⁷ N/m
Z-axis force (K _z)	3.4x10 ⁵ lb/in	5.9x10 ⁷ N/m
X-axis & Y-axis torque (K _{tx} , K _{ty})	4.6x10 ⁵ lbf-in/rad	5.2x10 ⁴ Nm/rad
Z-axis torque (K _{tz})	8.1x10 ⁵ lbf-in/rad	9.1x10 ⁴ Nm/rad
Resonant Frequency		
F _x , F _y , T _z	1500 Hz	1500 Hz
F _z , T _x , T _y	1700 Hz	1700 Hz
Physical Specifications		
Weight ¹	2.01 lb	0.913 kg
Diameter ¹	3.72 in	94.5 mm
Height ¹	1.31 in	33.3 mm
Note:		
1. Specifications include standard interface plates.		

5.14.2 Delta IP60 Physical Properties

Table 5.86—Delta IP60 Physical Properties		
Single-Axis Overload	(US) Standard Units	(SI) Metric Units
Fxy	±840 lbf	±3700 N
Fz	±2300 lbf	±10000 N
Txy	±2500 inf-lb	±280 Nm
Tz	±3600 inf-lb	±400 Nm
Stiffness (Calculated)		
X-axis & Y-axis forces (Kx, Ky)	2.0x10 ⁵ lb/in	3.6x10 ⁷ N/m
Z-axis force (Kz)	3.4x10 ⁵ lb/in	5.9x10 ⁷ N/m
X-axis & Y-axis torque (Ktx, Kty)	4.6x10 ⁵ lbf-in/rad	5.2x10 ⁴ Nm/rad
Z-axis torque (Ktz)	8.1x10 ⁵ lbf-in/rad	9.1x10 ⁴ Nm/rad
Resonant Frequency		
Fx, Fy, Tz	1100 Hz	1100 Hz
Fz, Tx, Ty	1100 Hz	1100 Hz
Physical Specifications		
Weight ¹	4 lb	1.81 kg
Diameter ¹	4.6 in	117 mm
Height ¹	1.85 in	47.1 mm
Note: 1. Specifications include standard interface plates.		

5.14.3 Delta IP65 Physical Properties

Table 5.87—Delta IP65 Physical Properties		
Single-Axis Overload	(US) Standard Units	(SI) Metric Units
Fxy	±840 lbf	±3700 N
Fz	±2300 lbf	±10000 N
Txy	±2500 inf-lb	±280 Nm
Tz	±3600 inf-lb	±400 Nm
Stiffness (Calculated)		
X-axis & Y-axis forces (Kx, Ky)	2.0x10 ⁵ lb/in	3.6x10 ⁷ N/m
Z-axis force (Kz)	3.4x10 ⁵ lb/in	5.9x10 ⁷ N/m
X-axis & Y-axis torque (Ktx, Kty)	4.6x10 ⁵ lbf-in/rad	5.2x10 ⁴ Nm/rad
Z-axis torque (Ktz)	8.1x10 ⁵ lbf-in/rad	9.1x10 ⁴ Nm/rad
Resonant Frequency		
Fx, Fy, Tz	880 Hz	880 Hz
Fz, Tx, Ty	920 Hz	920 Hz
Physical Specifications		
Weight ¹	3.91 lb	1.77 kg
Diameter ¹	4.96 in	126 mm
Height ¹	2.06 in	52.2 mm
Note: 1. Specifications include standard interface plates.		

5.14.4 Delta IP68 Physical Properties

Table 5.88—Delta IP68 Physical Properties		
Single-Axis Overload	(US) Standard Units	(SI) Metric Units
Fxy	±840 lbf	±3700 N
Fz	±2300 lbf	±10000 N
Txy	±2500 inf-lb	±280 Nm
Tz	±3600 inf-lb	±400 Nm
Stiffness (Calculated)		
X-axis & Y-axis forces (Kx, Ky)	2.0x10 ⁵ lb/in	3.6x10 ⁷ N/m
Z-axis force (Kz)	3.4x10 ⁵ lb/in	5.9x10 ⁷ N/m
X-axis & Y-axis torque (Ktx, Kty)	4.6x10 ⁵ lbf-in/rad	5.2x10 ⁴ Nm/rad
Z-axis torque (Ktz)	8.1x10 ⁵ lbf-in/rad	9.1x10 ⁴ Nm/rad
Resonant Frequency		
Fx, Fy, Tz	950 Hz	950 Hz
Fz, Tx, Ty	960 Hz	960 Hz
Physical Specifications		
Weight ¹	5.8 lb	2.63 kg
Diameter ¹	4 in	102 mm
Height ¹	2.06 in	52.2 mm
Note: 1. Specifications include standard interface plates.		



CAUTION: When submerged, IP68 transducers exhibit a decrease in Fz range related to the submersion depth. This loss is the result of pressure-induced preloading on the transducer. The preload can be masked by biasing the transducer at the depth prior to applying the load to be measured. The following estimates are for room temperature fresh water at sea level.

Submersion Depth		
IP68 Delta	US	Metric
Fz preload at 10 m depth	161 lb	716 N
Fz preload at other depths	-4.9 lb/ft x depthInFeet	-72 N/m x depthInMeters

5.14.5 Calibration Specifications (excludes CTL calibrations)

Table 5.89— Delta Calibrations (excludes CTL calibrations) ^{1, 2}										
Sensor	(US) Standard Calibration	Fx,Fy (lbf)	Fz ³ (lbf)	Tx,Ty (lbf-in)	Tz (lbf-in)	Fx,Fy (lbf)	Fz ³ (lbf)	Tx,Ty (lbf-in)	Tz (lbf-in)	
Delta	US-50-150	50	150	150	150	1/128	1/64	3/128	1/64	
Delta	US-75-300	75	225	300	300	1/64	1/32	3/64	1/32	
Delta	US-150-600	150	450	600	600	1/32	1/16	3/32	1/16	
Sensor	(SI) Metric Calibration	Fx,Fy (N)	Fz ³ (N)	Tx,Ty (Nm)	Tz (Nm)	Fx,Fy (N)	Fz ³ (N)	Tx,Ty (Nm)	Tz (Nm)	
Delta	SI-165-15	165	495	15	15	1/32	1/16	1/528	1/528	
Delta	SI-330-30	330	990	30	30	1/16	1/8	5/1333	5/1333	
Delta	SI-660-60	660	1980	60	60	1/8	1/4	10/1333	10/1333	
					Sensing Ranges	Resolution (DAQ, Net F/T) ⁴				

Notes:

1. These system resolutions quoted are the effective resolution after dropping four counts of noise. The effective resolution can be improved with filtering.
2. Applied loads must be within range in each of the six axes for the F/T sensor to measure correctly.
3. For IP68 version see caution on physical properties page.
4. DAQ resolutions are typical for a 16-bit data acquisition system.

5.14.6 CTL Calibration Specifications

Table 5.90— Delta CTL Calibrations ^{1, 2}										
Sensor	(US) Standard Calibration	Fx,Fy (lbf)	Fz ³ (lbf)	Tx,Ty (lbf-in)	Tz (lbf-in)	Fx,Fy (lbf)	Fz ³ (lbf)	Tx,Ty (lbf-in)	Tz (lbf-in)	
Delta	US-50-150	50	150	150	150	1/64	1/32	3/64	1/32	
Delta	US-75-300	75	225	300	300	1/32	1/16	3/32	1/16	
Delta	US-150-600	150	450	600	600	1/16	1/8	3/16	1/8	
Sensor	(SI) Metric Calibration	Fx,Fy (N)	Fz ³ (N)	Tx,Ty (Nm)	Tz (Nm)	Fx,Fy (N)	Fz ³ (N)	Tx,Ty (Nm)	Tz (Nm)	
Delta	SI-165-15	165	495	15	15	1/16	1/8	1/264	1/264	
Delta	SI-330-30	330	990	30	30	1/8	1/4	10/1333	10/1333	
Delta	SI-660-60	660	1980	60	60	1/4	1/2	5/333	5/333	
					Sensing Ranges	Resolution (Controller)				

Notes:

1. CTL resolutions are typical. System resolutions quoted are the effective resolution after dropping eight counts of noise. The effective resolution can be improved with filtering.
2. Applied loads must be within range in each of the six axes for the F/T sensor to measure correctly.
3. For IP68 version see caution on physical properties page.

5.14.7 CTL Analog Output

Table 5.91— Delta Analog Output							
Sensor	(US) Standard Calibration	F _x ,F _y (lbf)	F _z ² (lbf)	T _x ,T _y ,T _z (lbf-in)	F _x ,F _y (lbf/V)	F _z ² (lbf/V)	T _x ,T _y ,T _z (lbf-in/V)
Delta	US-50-150	±50	±150	±150	5	15	15
Delta	US-75-300	±75	±225	±300	7.5	22.5	30
Delta	US-150-600	±150	±450	±600	15	45	60
Sensor	(SI) Metric Calibration	F _x ,F _y (N)	F _z ² (N)	T _x ,T _y ,T _z (Nm)	F _x ,F _y (N/V)	F _z ² (N/V)	T _x ,T _y ,T _z (Nm/V)
Delta	SI-165-15	±165	±495	±15	16.5	49.5	1.5
Delta	SI-330-30	±330	±990	±30	33	99	3
Delta	SI-660-60	±660	±1980	±60	66	198	6
				Analog Output Range	Analog ±10V Sensitivity¹		

Notes:
 1. ±5V Sensitivity values are double the listed ±10V Sensitivity values.
 2. For IP68 version see caution on physical properties page.

5.14.8 CTL Counts Value

Table 5.92—Counts Value					
Sensor	Calibration	F _x , F _y , F _z (/ lbf)	T _x , T _y , T _z (/ lbf-in)	F _x , F _y , F _z (/ N)	T _x , T _y , T _z (/ Nm)
Delta	US-7.5–25 / SI-32–2.5	512	512	128	2112
Delta	US-15–50 / SI-65–5	256	256	64	1066.67
Delta	US-30–100 / SI-130–10	128	128	32	533.333
Delta	Tool Transform Factor	0.01 in/lbf		0.6 mm/N	
		Counts Value – Standard (US)	Counts Value – Metric (SI)		

5.14.9 Delta (US Calibration Complex Loading)(Includes IP60/IP65/IP68)¹

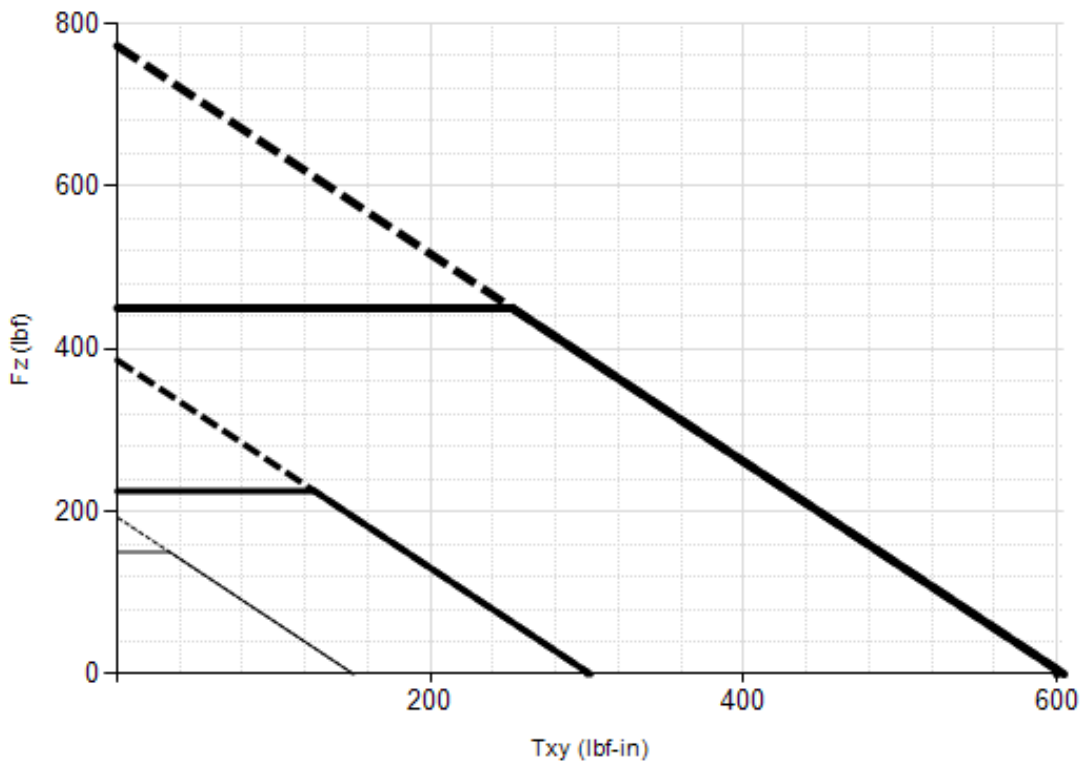
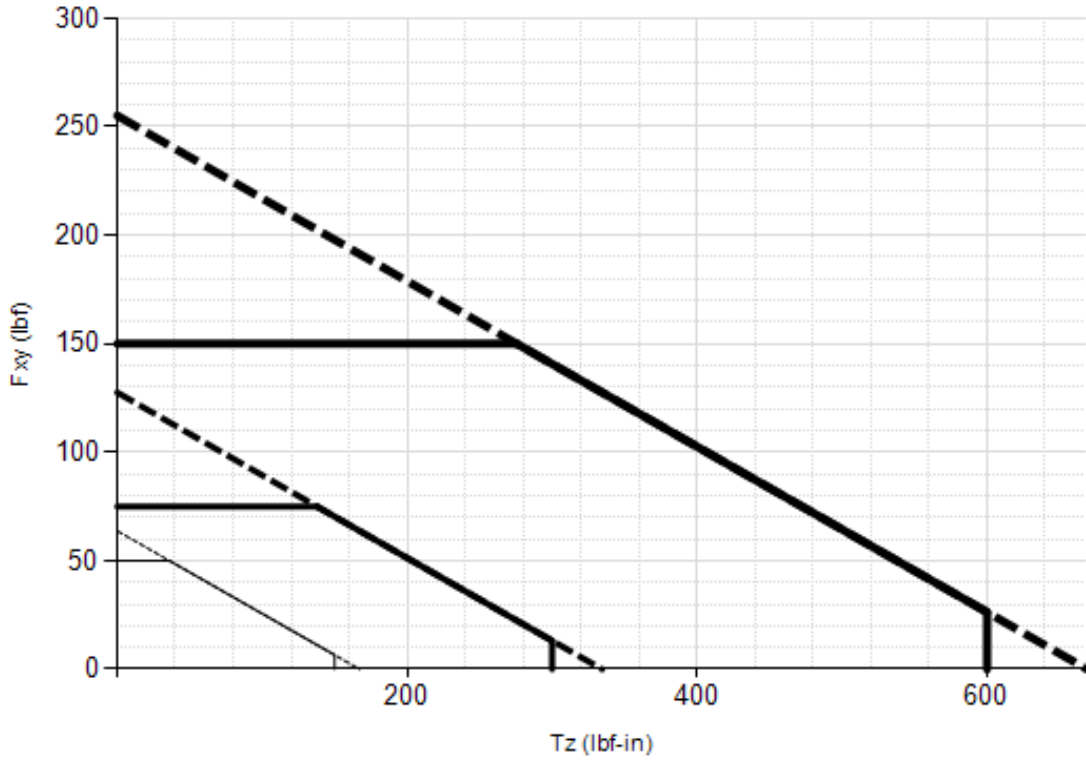

US-50-150
 US-75-300
 US-150-600

Note: 1. For IP68 version see caution on physical properties page.

5.14.10 Delta (SI Calibration Complex Loading)(Includes IP60/IP65/IP68)¹

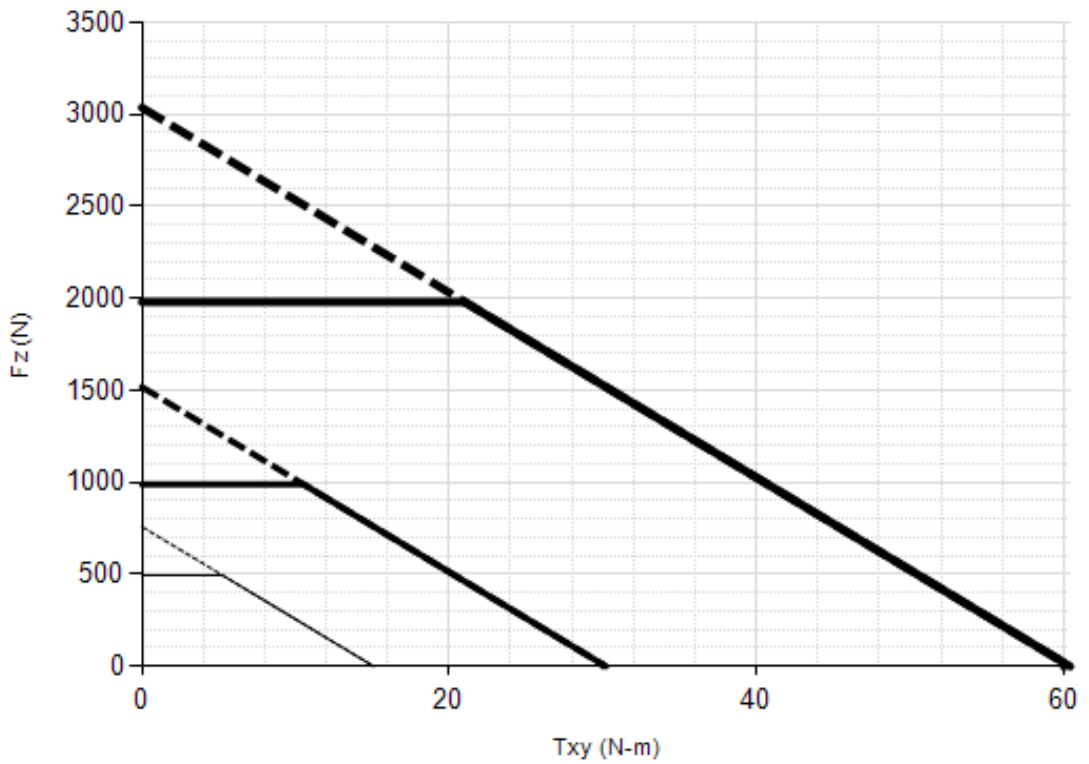
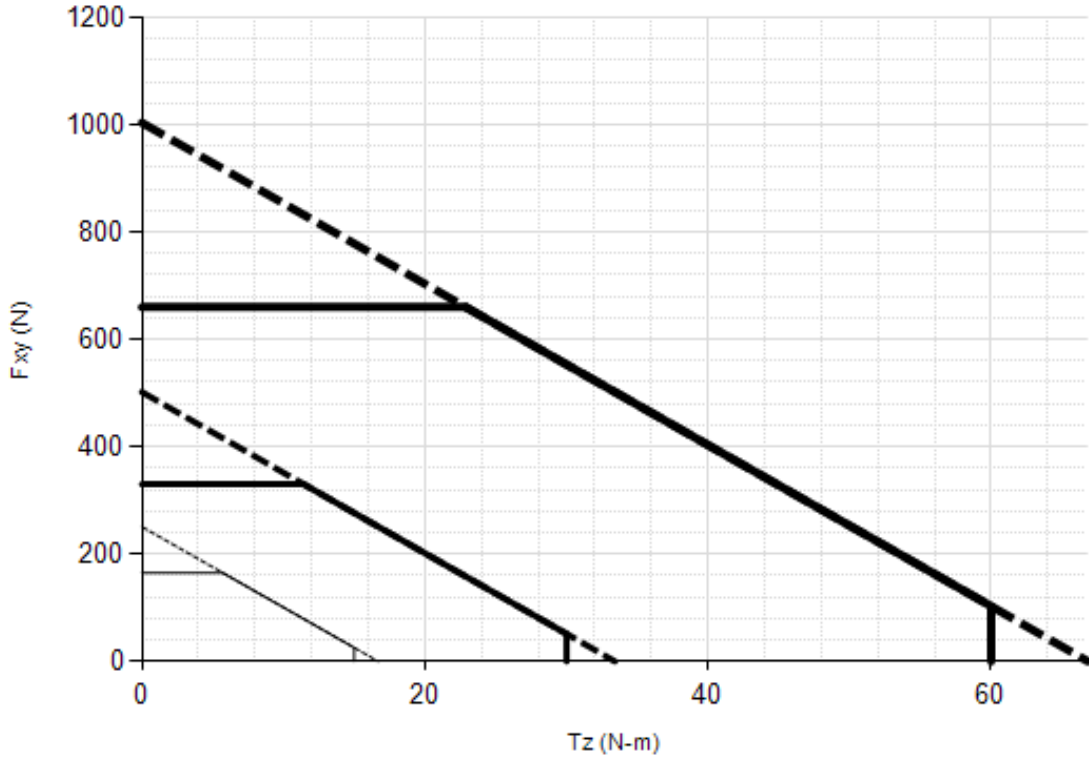

SI-165-15
 SI-330-30
 SI-660-60

Note: 1. For IP68 version see caution on physical properties page.

5.15 Theta Specifications (Includes IP60/IP65/IP68 Versions)

In addition to the information in the following sections, refer to the ATI website:

Table 5.93—Theta Drawing and Web Links		
Model	Drawing Part Number	ATI Website Address
Theta Mux ¹ transducer without standard mounting adapter	9230-05-1104	https://www.ati-ia.com/products/ft/ft_models.aspx?id=Theta
Theta DAQ/NET transducer with mounting adapter plate	9230-05-1331	
Theta adapter mounting plate (non-IP rated)	9230-05-1076	
Theta IP60	9230-05-1263	https://www.ati-ia.com/products/ft/ft_models.aspx?id=Theta+IP60
Theta IP65	9230-05-1268	https://www.ati-ia.com/products/ft/ft_models.aspx?id=Theta+IP65%2fIP68
Theta IP68-10m	9230-05-1273	
Note:		
1. Mux transducers are used in F/T Controller systems.		

5.15.1 Theta Physical Properties

Table 5.94—Theta Physical Properties		
Single-Axis Overload	(US) Standard Units	(SI) Metric Units
Fxy	±4500 lbf	±20000 N
Fz	±11000 lbf	±51000 N
Txy	±18000 inf-lb	±2000 Nm
Tz	±18000 inf-lb	±2000 Nm
Stiffness (Calculated)		
X-axis & Y-axis forces (Kx, Ky)	4.0x10 ⁵ lb/in	7.1x10 ⁷ N/m
Z-axis force (Kz)	6.9x10 ⁵ lb/in	1.2x10 ⁸ N/m
X-axis & Y-axis torque (Ktx, Kty)	3.0x10 ⁶ lbf-in/rad	3.4x10 ⁵ Nm/rad
Z-axis torque (Ktz)	4.7x10 ⁶ lbf-in/rad	5.3x10 ⁵ Nm/rad
Resonant Frequency		
Fx, Fy, Tz	680 Hz	680 Hz
Fz, Tx, Ty	820 Hz	820 Hz
Physical Specifications		
Weight ¹	11 lb	4.99 kg
Diameter ¹	6.1 in	155 mm
Height ¹	2.41 in	61.1 mm
Note:		
1. Specifications include standard interface plates.		

5.15.2 Theta IP60 Physical Properties

Table 5.95—Theta IP60 Physical Properties		
Single-Axis Overload	(US) Standard Units	(SI) Metric Units
Fxy	±4500 lbf	±20000 N
Fz	±11000 lbf	±51000 N
Txy	±18000 inf-lb	±2000 Nm
Tz	±18000 inf-lb	±2000 Nm
Stiffness (Calculated)		
X-axis & Y-axis forces (Kx, Ky)	4.0x10 ⁵ lb/in	7.1x10 ⁷ N/m
Z-axis force (Kz)	6.9x10 ⁵ lb/in	1.2x10 ⁸ N/m
X-axis & Y-axis torque (Ktx, Kty)	3.0x10 ⁶ lbf-in/rad	3.4x10 ⁵ Nm/rad
Z-axis torque (Ktz)	4.7x10 ⁶ lbf-in/rad	5.3x10 ⁵ Nm/rad
Resonant Frequency		
Fx, Fy, Tz	N/A	N/A
Fz, Tx, Ty	N/A	N/A
Physical Specifications		
Weight ¹	19 lb	8.62 kg
Diameter ¹	7.63 in	194 mm
Height ¹	2.91 in	74 mm
Note: 1. Specifications include standard interface plates.		

5.15.3 Theta IP65/IP68 Physical Properties

Table 5.96—Theta IP65/IP68 Physical Properties		
Single-Axis Overload	(US) Standard Units	(SI) Metric Units
Fxy	±4500 lbf	±20000 N
Fz	±11000 lbf	±51000 N
Txy	±18000 inf-lb	±2000 Nm
Tz	±18000 inf-lb	±2000 Nm
Stiffness (Calculated)		
X-axis & Y-axis forces (Kx, Ky)	4.0x10 ⁵ lb/in	7.1x10 ⁷ N/m
Z-axis force (Kz)	6.9x10 ⁵ lb/in	1.2x10 ⁸ N/m
X-axis & Y-axis torque (Ktx, Kty)	3.0x10 ⁶ lbf-in/rad	3.4x10 ⁵ Nm/rad
Z-axis torque (Ktz)	4.7x10 ⁶ lbf-in/rad	5.3x10 ⁵ Nm/rad
Resonant Frequency		
Fx, Fy, Tz	N/A	N/A
Fz, Tx, Ty	N/A	N/A
Physical Specifications		
Weight ¹	19.8 lb	9 kg
Diameter ¹	6.41 in	163 mm
Height ¹	2.95 in	74.8 mm
Note: 1. Specifications include standard interface plates.		



CAUTION: When submerged, IP68 transducers exhibit a decrease in Fz range related to the submersion depth. This loss is the result of pressure-induced preloading on the transducer. The preload can be masked by biasing the transducer at the depth prior to applying the load to be measured. The following estimates are for room temperature fresh water at sea level.

Submersion Depth		
IP68 Theta	US	Metric
Fz preload at 10 m depth	429 lb	1907 N
Fz preload at other depths	-13 lb/ft x depthInFeet	-191 N/m x depthInMeters

5.15.4 Calibration Specifications (excludes CTL calibrations)

Table 5.97— Theta Calibrations (excludes CTL calibrations) ^{1, 2}										
Sensor	(US) Standard Calibration	Fx,Fy (lbf)	Fz ³ (lbf)	Tx,Ty (lbf-in)	Tz (lbf-in)	Fx,Fy (lbf)	Fz ³ (lbf)	Tx,Ty (lbf-in)	Tz (lbf-in)	
Theta	US-200-1000	200	500	1000	1000	1/32	1/16	1/8	1/8	
Theta	US-300-1800	300	875	1800	1800	5/68	5/34	5/16	5/16	
Theta	US-600-3600	600	1500	3600	3600	1/8	1/4	1/2	1/2	
Sensor	(SI) Metric Calibration	Fx,Fy (N)	Fz ³ (N)	Tx,Ty (Nm)	Tz (Nm)	Fx,Fy (N)	Fz ³ (N)	Tx,Ty (Nm)	Tz (Nm)	
Theta	SI-1000-120	1000	2500	120	120	1/4	1/4	1/40	1/80	
Theta	SI-1500-240	1500	3750	240	240	1/2	1/2	1/20	1/40	
Theta	SI-2500-400	2500	6250	400	400	1/2	1	1/20	1/20	
					Sensing Ranges	Resolution (DAQ, Net F/T) ⁴				

Notes:

1. These system resolutions quoted are the effective resolution after dropping four counts of noise. The effective resolution can be improved with filtering.
2. Applied loads must be within range in each of the six axes for the F/T sensor to measure correctly.
3. For IP68 version see caution on physical properties page.
4. DAQ resolutions are typical for a 16-bit data acquisition system.

5.15.5 CTL Calibration Specifications

Table 5.98— Theta CTL Calibrations ^{1, 2}										
Sensor	(US) Standard Calibration	Fx,Fy (lbf)	Fz ³ (lbf)	Tx,Ty (lbf-in)	Tz (lbf-in)	Fx,Fy (lbf)	Fz ³ (lbf)	Tx,Ty (lbf-in)	Tz (lbf-in)	
Theta	US-200-1000	200	500	1000	1000	1/16	1/8	1/4	1/4	
Theta	US-300-1800	300	875	1800	1800	5/34	5/17	5/8	5/8	
Theta	US-600-3600	600	1500	3600	3600	1/4	1/2	1	1	
Sensor	(SI) Metric Calibration	Fx,Fy (N)	Fz ³ (N)	Tx,Ty (Nm)	Tz (Nm)	Fx,Fy (N)	Fz ³ (N)	Tx,Ty (Nm)	Tz (Nm)	
Theta	SI-1000-120	1000	2500	120	120	1/2	1/2	1/20	1/40	
Theta	SI-1500-240	1500	3750	240	240	1	1	1/10	1/20	
Theta	SI-2500-400	2500	6250	400	400	1	2	1/10	1/10	
					Sensing Ranges	Resolution (Controller)				

Notes:

1. CTL resolutions are typical. System resolutions quoted are the effective resolution after dropping eight counts of noise. The effective resolution can be improved with filtering.
2. Applied loads must be within range in each of the six axes for the F/T sensor to measure correctly.
3. For IP68 version see caution on physical properties page.

5.15.6 CTL Analog Output

Table 5.99— Theta Analog Output							
Sensor	(US) Standard Calibration	Fx,Fy (lbf)	Fz ² (lbf)	Tx,Ty,Tz (lbf-in)	Fx,Fy (lbf/V)	Fz ² (lbf/V)	Tx,Ty,Tz (lbf-in/V)
Theta	US-200-1000	±200	±500	±1000	20	50	100
Theta	US-300-1800	±300	±875	±1800	30	87.5	180
Theta	US-600-3600	±600	±1500	±3600	60	150	360
Sensor	(SI) Metric Calibration	Fx,Fy (N)	Fz ² (N)	Tx,Ty,Tz (Nm)	Fx,Fy (N/V)	Fz ² (N/V)	Tx,Ty,Tz (Nm/V)
Theta	SI-1000-120	±1000	±2500	±120	100	250	12
Theta	SI-1500-240	±1500	±3750	±240	150	375	24
Theta	SI-2500-400	±2500	±6250	±400	250	625	40
				Analog Output Range		Analog ±10V Sensitivity ¹	

Notes:

- ±5V Sensitivity values are double the listed ±10V Sensitivity values.
- For IP68 version see caution on physical properties page.

5.15.7 CTL Counts Value

Table 5.100—Counts Value					
Sensor	Calibration	Fx, Fy, Fz (/ lbf)	Tx, Ty, Tz (/ lbf-in)	Fx, Fy, Fz (/ N)	Tx, Ty, Tz (/ Nm)
Theta	US-200–1000 / SI-1000–120	128	64	32	320
Theta	US-300–1800 / SI-1500–240	54.4	12.8	16	160
Theta	US-600–3600 / SI-2500–400	32	16	16	80
Theta	Tool Transform Factor	See Tool Transform Factor table			
		Counts Value – Standard (US)		Counts Value – Metric (SI)	

5.15.8 Tool Transform Factor

Table 5.101—Tool Transform Factor			
Sensor	Calibration	US (English)	SI (Metric)
Theta	US-200–1000 / SI-1000–120	0.02 in/lbf	1 mm/N
Theta	US-300–1800 / SI-1500–240	0.0425 in/lbf	1 mm/N
Theta	US-600–3600 / SI-2500–400	0.02 in/lbf	2 mm/N

5.15.9 Theta (US Calibration Complex Loading)(Includes IP60/IP65/IP68)¹

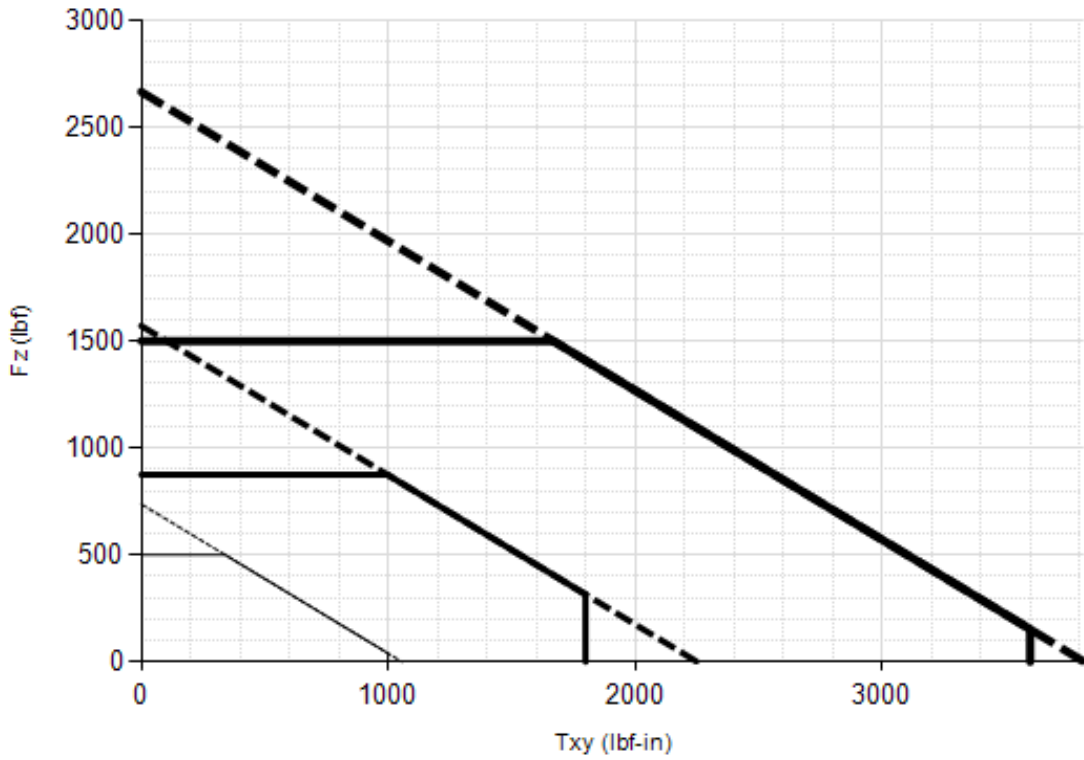
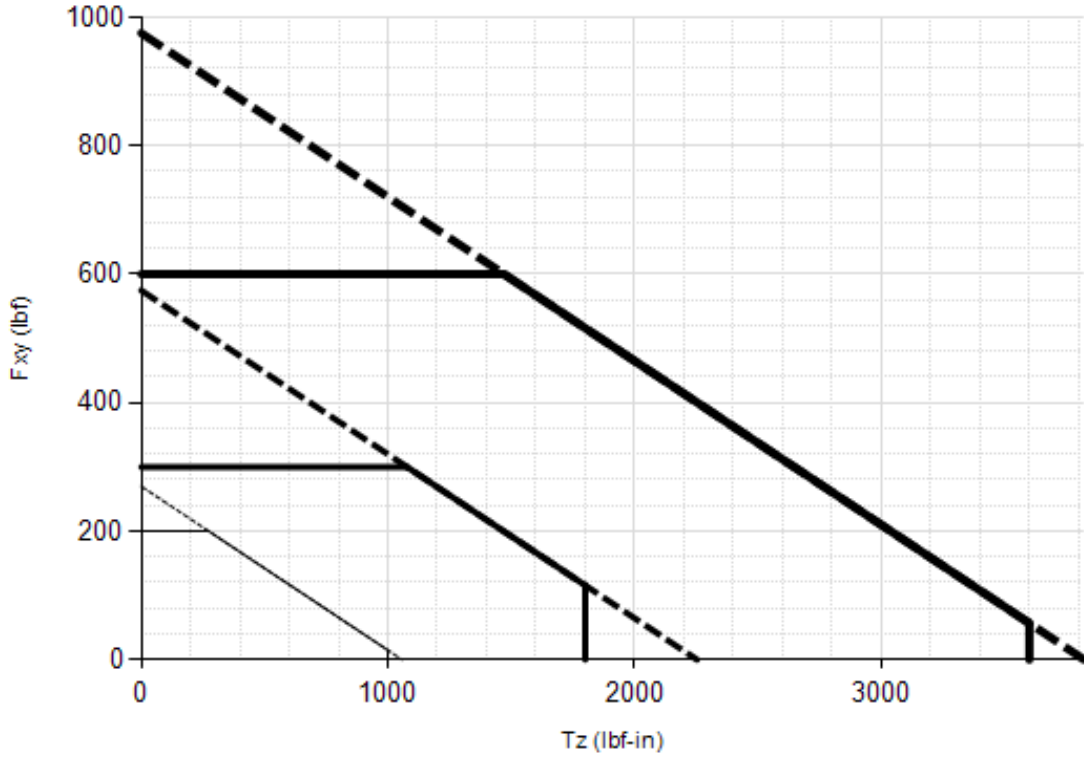

US-200-1000
 US-300-1800
 US-600-3600

Note: 1. For IP68 version see caution on physical properties page.

5.15.10 Theta (SI Calibration Complex Loading)(Includes IP60/IP65/IP68)¹

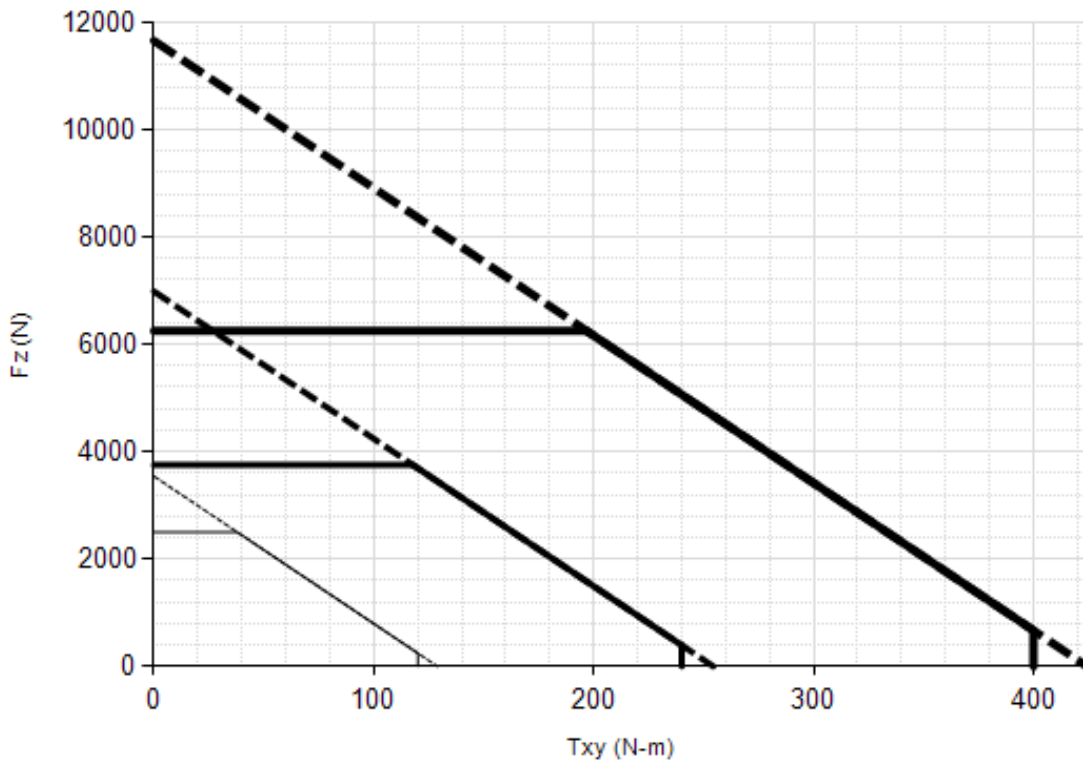
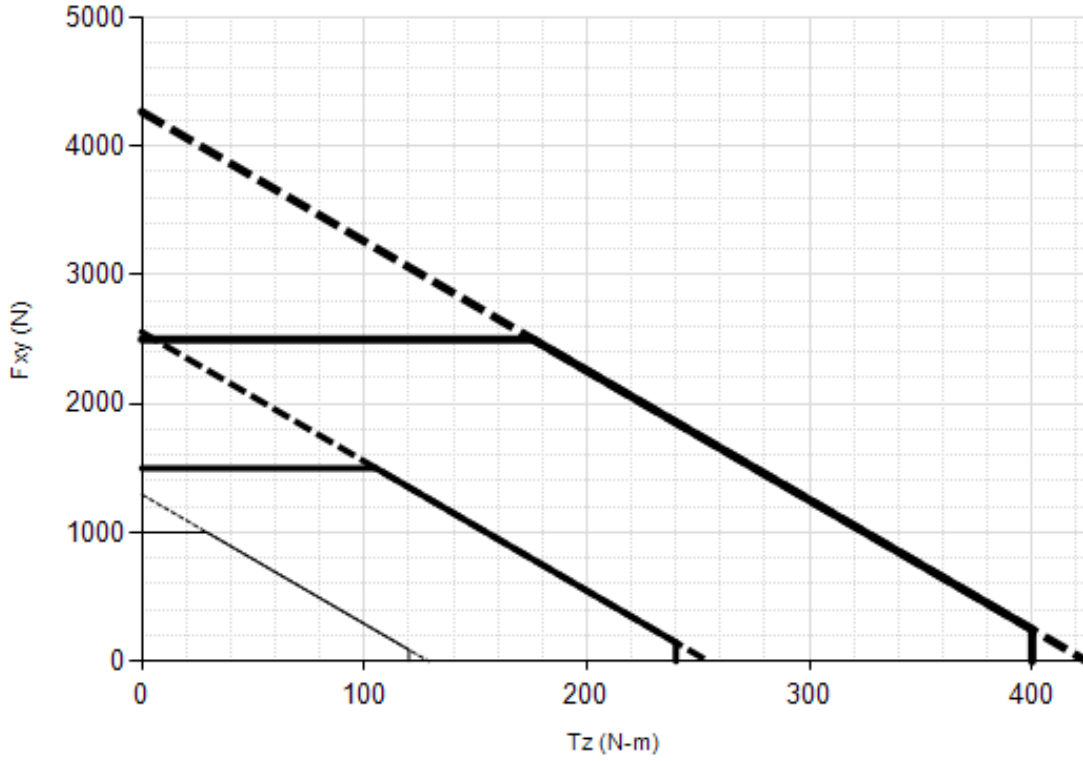

SI-1000-120
 SI-1500-240
 SI-2500-400

5.16 Omega85 Specifications (Includes IP60/IP65/IP68 Versions)

In addition to the information in the following sections, refer to the ATI website:

Model	Drawing Part Number	ATI Website Address
Omega85	9230-05-1341	https://www.ati-ia.com/products/ft/ft_models.aspx?id=Omega85
Omega85 IP65	9230-05-1382	https://www.ati-ia.com/products/ft/ft_models.aspx?id=Omega85+IP65%2fIP68
Omega85 IP68	9230-05-1396	

5.16.1 Omega85 Physical Properties

Single-Axis Overload	(US) Standard Units	(SI) Metric Units
Fxy	±2800 lbf	±13000 N
Fz	±6100 lbf	±27000 N
Txy	±4400 inf-lb	±500 Nm
Tz	±5400 inf-lb	±610 Nm
Stiffness (Calculated)		
X-axis & Y-axis forces (Kx, Ky)	4.4x10 ⁵ lb/in	7.7x10 ⁷ N/m
Z-axis force (Kz)	6.8x10 ⁵ lb/in	1.2x10 ⁸ N/m
X-axis & Y-axis torque (Ktx, Kty)	7.2x10 ⁵ lbf-in/rad	8.1x10 ⁴ Nm/rad
Z-axis torque (Ktz)	1.2x10 ⁶ lbf-in/rad	1.3x10 ⁵ Nm/rad
Resonant Frequency		
Fx, Fy, Tz	2100 Hz	2100 Hz
Fz, Tx, Ty	3000 Hz	3000 Hz
Physical Specifications		
Weight ¹	1.45 lb	0.658 kg
Diameter ¹	3.35 in	85.1 mm
Height ¹	1.32 in	33.4 mm
Note: 1. Specifications include standard interface plates.		

5.16.2 Omega85 IP65/IP68 Physical Properties

Table 5.104—Omega85 IP65/IP68 Physical Properties		
Single-Axis Overload	(US) Standard Units	(SI) Metric Units
Fxy	±2800 lbf	±13000 N
Fz	±6100 lbf	±27000 N
Txy	±4400 inf-lb	±500 Nm
Tz	±5400 inf-lb	±610 Nm
Stiffness (Calculated)		
X-axis & Y-axis forces (Kx, Ky)	4.4x10 ⁵ lb/in	7.7x10 ⁷ N/m
Z-axis force (Kz)	6.8x10 ⁵ lb/in	1.2x10 ⁸ N/m
X-axis & Y-axis torque (Ktx, Kty)	7.2x10 ⁵ lbf-in/rad	8.1x10 ⁴ Nm/rad
Z-axis torque (Ktz)	1.2x10 ⁶ lbf-in/rad	1.3x10 ⁵ Nm/rad
Resonant Frequency		
Fx, Fy, Tz	N/A	N/A
Fz, Tx, Ty	N/A	N/A
Physical Specifications		
Weight ¹	4.2 lb	1.91 kg
Diameter ¹	3.65 in	92.7 mm
Height ¹	1.52 in	38.7 mm
Note: 1. Specifications include standard interface plates.		



CAUTION: When submerged, IP68 transducers exhibit a decrease in Fz range related to the submersion depth. This loss is the result of pressure-induced preloading on the transducer. The preload can be masked by biasing the transducer at the depth prior to applying the load to be measured. The following estimates are for room temperature fresh water at sea level.

Submersion Depth		
IP68 Omega85	US	Metric
Fz preload at 10 m depth	128 lb	570 N
Fz preload at other depths	-3.9 lb/ft x depthInFeet	-57 N/m x depthInMeters

5.16.3 Calibration Specifications (excludes CTL calibrations)

Table 5.105— Omega85 Calibrations (excludes CTL calibrations)1, 2									
Sensor	(US) Standard Calibration	Fx,Fy (lbf)	Fz ³ (lbf)	Tx,Ty (lbf-in)	Tz (lbf-in)	Fx,Fy (lbf)	Fz ³ (lbf)	Tx,Ty (lbf-in)	Tz (lbf-in)
Omega85	US-105-185	105	210	185	185	1/52	3/130	3/112	1/48
Omega85	US-210-370	210	420	370	370	5/128	3/64	3/56	1/24
Omega85	US-420-740	420	840	740	740	5/64	3/32	3/28	1/12
Sensor	(SI) Metric Calibration	Fx,Fy (N)	Fz ³ (N)	Tx,Ty (Nm)	Tz (Nm)	Fx,Fy (N)	Fz ³ (N)	Tx,Ty (Nm)	Tz (Nm)
Omega85	SI-475-20	475	950	20	20	1/14	3/28	5/1496	7/2992
Omega85	SI-950-40	950	1900	40	40	1/7	3/14	5/748	7/1496
Omega85	SI-1900-80	1900	3800	80	80	2/7	3/7	5/374	7/748
		Sensing Ranges				Resolution (DAQ, Net F/T)⁴			

Notes:

1. These system resolutions quoted are the effective resolution after dropping four counts of noise. The effective resolution can be improved with filtering.
2. Applied loads must be within range in each of the six axes for the F/T sensor to measure correctly.
3. For IP68 version see caution on physical properties page.
4. DAQ resolutions are typical for a 16-bit data acquisition system.

NOTICE: The Omega85 does not support an on-board mux board, therefore it cannot be used with the F/T Controller. For Controller F/T systems we recommend the Mini85.

5.16.4 Omega85 (US Calibration Complex Loading)(Includes IP65/IP68)¹

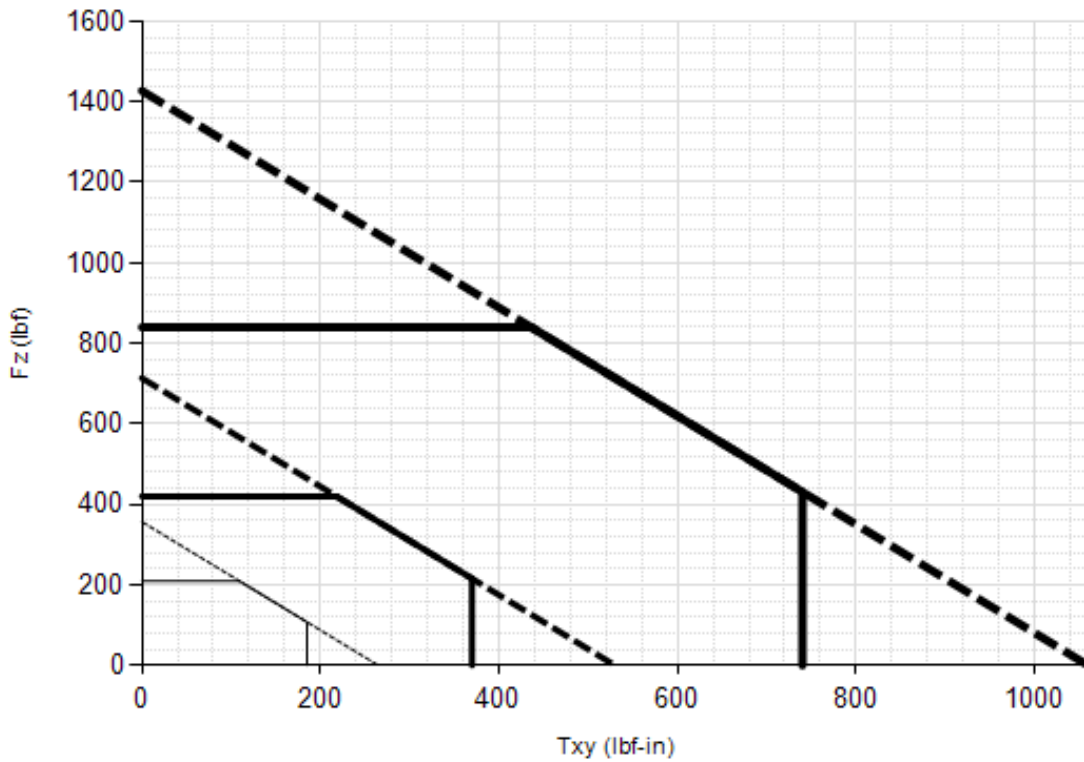
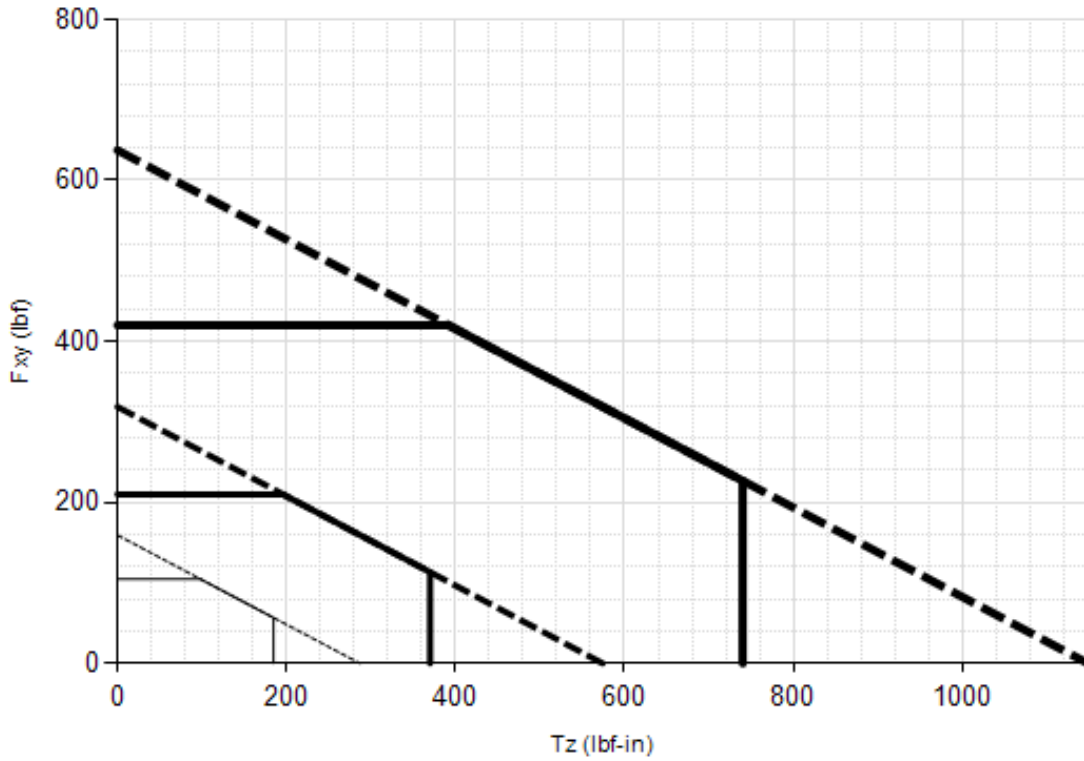

US-105-185
 US-210-370
 US-420-740

Note: 1. For IP68 version see caution on physical properties page.

5.17 Omega160 Specifications (Includes IP60/IP65/IP68 Versions)

NOTICE: For transducer versions without a through hole and without an IP rating, use a metallic adapter plate that covers the center hole.

In addition to the information in the following sections, refer to the ATI website:

Model	Drawing Part Number	ATI Website Address
Omega160 Mux ¹ without mounting adapter plate	9230-05-1093	https://www.ati-ia.com/products/ft/ft_models.aspx?id=Omega160
Omega160 DAQ/NET with mounting adapter plate	9230-05-1131	
TIF Omega160 with 53 mm hole	9230-05-1412	
Omega160 IP60	9230-05-1264	https://www.ati-ia.com/products/ft/ft_models.aspx?id=Omega160+IP60
Omega160 IP60 ECAT	9230-05-1487	
Omega160 IP65	9230-05-1269	https://www.ati-ia.com/products/ft/ft_models.aspx?id=Omega160+IP65%2fIP68
Omega160 IP68-10 m	9230-05-1274	
Omega160 IP65 ECAT	9230-05-1499	
Note:		
1. Mux transducers are used in F/T Controller systems.		

5.17.1 Omega160 Physical Properties

Single-Axis Overload	(US) Standard Units	(SI) Metric Units
Fxy	±3900 lbf	±18000 N
Fz	±11000 lbf	±48000 N
Txy	±15000 inf-lb	±1700 Nm
Tz	±17000 inf-lb	±1900 Nm
Stiffness (Calculated)		
X-axis & Y-axis forces (Kx, Ky)	4.0x10 ⁵ lb/in	7.0x10 ⁷ N/m
Z-axis force (Kz)	6.8x10 ⁵ lb/in	1.2x10 ⁸ N/m
X-axis & Y-axis torque (Ktx, Kty)	2.9x10 ⁶ lbf-in/rad	3.3x10 ⁵ Nm/rad
Z-axis torque (Ktz)	4.6x10 ⁶ lbf-in/rad	5.2x10 ⁵ Nm/rad
Resonant Frequency		
Fx, Fy, Tz	1300 Hz	1300 Hz
Fz, Tx, Ty	1000 Hz	1000 Hz
Physical Specifications		
Weight ¹	6 lb	2.72 kg
Diameter ¹	6.16 in	157 mm
Height ¹	2.2 in	55.9 mm
Note:		
1. Specifications include standard interface plates.		

5.17.2 Omega160 IP160 Physical Properties (Includes ECAT)

Table 5.108—Omega160 IP160 Physical Properties		
Single-Axis Overload	(US) Standard Units	(SI) Metric Units
Fxy	±3900 lbf	±18000 N
Fz	±11000 lbf	±48000 N
Txy	±15000 inf-lb	±1700 Nm
Tz	±17000 inf-lb	±1900 Nm
Stiffness (Calculated)		
X-axis & Y-axis forces (Kx, Ky)	4.0x10 ⁵ lb/in	7.0x10 ⁷ N/m
Z-axis force (Kz)	6.8x10 ⁵ lb/in	1.2x10 ⁸ N/m
X-axis & Y-axis torque (Ktx, Kty)	2.9x10 ⁶ lbf-in/rad	3.3x10 ⁵ Nm/rad
Z-axis torque (Ktz)	4.6x10 ⁶ lbf-in/rad	5.2x10 ⁵ Nm/rad
Resonant Frequency		
Fx, Fy, Tz	1100 Hz	1100 Hz
Fz, Tx, Ty	1000 Hz	1000 Hz
Physical Specifications		
Weight ¹	16.9 lb	7.67 kg
Diameter ¹	7.63 in	194 mm
Height ¹	2.27 in	57.7 mm
Note: 1. Specifications include standard interface plates.		

5.17.3 Omega160 IP65/IP68 Physical Properties

Table 5.109—Omega160 IP65/IP68 Physical Properties		
Single-Axis Overload	(US) Standard Units	(SI) Metric Units
Fxy	±3900 lbf	±18000 N
Fz	±11000 lbf	±48000 N
Txy	±15000 inf-lb	±1700 Nm
Tz	±17000 inf-lb	±1900 Nm
Stiffness (Calculated)		
X-axis & Y-axis forces (Kx, Ky)	4.0x10 ⁵ lb/in	7.0x10 ⁷ N/m
Z-axis force (Kz)	6.8x10 ⁵ lb/in	1.2x10 ⁸ N/m
X-axis & Y-axis torque (Ktx, Kty)	2.9x10 ⁶ lbf-in/rad	3.3x10 ⁵ Nm/rad
Z-axis torque (Ktz)	4.6x10 ⁶ lbf-in/rad	5.2x10 ⁵ Nm/rad
Resonant Frequency		
Fx, Fy, Tz	1200 Hz	1200 Hz
Fz, Tx, Ty	900 Hz	900 Hz
Physical Specifications		
Weight ¹	16 lb	7.26 kg
Diameter ¹	6.5 in	165 mm
Height ¹	2.59 in	65.9 mm
Note: 1. Specifications include standard interface plates.		



CAUTION: When submerged, IP68 transducers exhibit a decrease in Fz range related to the submersion depth. This loss is the result of pressure-induced preloading on the transducer. The preload can be masked by biasing the transducer at the depth prior to applying the load to be measured. The following estimates are for room temperature fresh water at sea level.

Submersion Depth		
IP68 Omega160	US	Metric
Fz preload at 10 m depth	429 lb	1907 N
Fz preload at other depths	-13 lb/ft x depthInFeet	-191 N/m x depthInMeters

5.17.4 Calibration Specifications (excludes CTL calibrations)

Table 5.110— Omega160 Calibrations (excludes CTL calibrations)1, 2										
Sensor	(US) Standard Calibration	Fx,Fy (lbf)	Fz ³ (lbf)	Tx,Ty (lbf-in)	Tz (lbf-in)	Fx,Fy (lbf)	Fz ³ (lbf)	Tx,Ty (lbf-in)	Tz (lbf-in)	
Omega160	US-200-1000	200	500	1000	1000	1/32	1/16	1/8	1/8	
Omega160	US-300-1800	300	875	1800	1800	5/68	5/34	5/16	5/16	
Omega160	US-600-3600	600	1500	3600	3600	1/8	1/4	1/2	1/4	
Sensor	(SI) Metric Calibration	Fx,Fy (N)	Fz ³ (N)	Tx,Ty (Nm)	Tz (Nm)	Fx,Fy (N)	Fz ³ (N)	Tx,Ty (Nm)	Tz (Nm)	
Omega160	SI-1000-120	1000	2500	120	120	1/4	1/4	1/40	1/80	
Omega160	SI-1500-240	1500	3750	240	240	1/4	1/2	1/20	1/40	
Omega160	SI-2500-400	2500	6250	400	400	1/2	3/4	1/20	1/20	
					Sensing Ranges	Resolution (DAQ, Net F/T) ⁴				

Notes:

1. These system resolutions quoted are the effective resolution after dropping four counts of noise. The effective resolution can be improved with filtering.
2. Applied loads must be within range in each of the six axes for the F/T sensor to measure correctly.
3. For IP68 version see caution on physical properties page.
4. DAQ resolutions are typical for a 16-bit data acquisition system.

5.17.5 CTL Calibration Specifications

Table 5.111— Omega160 CTL Calibrations1, 2										
Sensor	(US) Standard Calibration	Fx,Fy (lbf)	Fz ³ (lbf)	Tx,Ty (lbf-in)	Tz (lbf-in)	Fx,Fy (lbf)	Fz ³ (lbf)	Tx,Ty (lbf-in)	Tz (lbf-in)	
Omega160	US-200-1000	200	500	1000	1000	1/16	1/8	1/4	1/4	
Omega160	US-300-1800	300	875	1800	1800	5/34	5/17	5/8	5/8	
Omega160	US-600-3600	600	1500	3600	3600	1/4	1/2	1	1/2	
Sensor	(SI) Metric Calibration	Fx,Fy (N)	Fz ³ (N)	Tx,Ty (Nm)	Tz (Nm)	Fx,Fy (N)	Fz ³ (N)	Tx,Ty (Nm)	Tz (Nm)	
Omega160	SI-1000-120	1000	2500	120	120	1/2	1/2	1/20	1/40	
Omega160	SI-1500-240	1500	3750	240	240	1/2	1	1/10	1/20	
Omega160	SI-2500-400	2500	6250	400	400	1	1 1/2	1/10	1/10	
					Sensing Ranges	Resolution (Controller)				

Notes:

1. CTL resolutions are typical. System resolutions quoted are the effective resolution after dropping eight counts of noise. The effective resolution can be improved with filtering.
2. Applied loads must be within range in each of the six axes for the F/T sensor to measure correctly.
3. For IP68 version see caution on physical properties page.

5.17.6 CTL Analog Output

Table 5.112— Omega160 Analog Output							
Sensor	(US) Standard Calibration	F _x ,F _y (lbf)	F _z ² (lbf)	T _x ,T _y ,T _z (lbf-in)	F _x ,F _y (lbf/V)	F _z ² (lbf/V)	T _x ,T _y ,T _z (lbf-in/V)
Omega160	US-200-1000	±200	±500	±1000	20	50	100
Omega160	US-300-1800	±300	±875	±1800	30	87.5	180
Omega160	US-600-3600	±600	±1500	±3600	60	150	360
Sensor	(SI) Metric Calibration	F _x ,F _y (N)	F _z (N)	T _x ,T _y ,T _z (Nm)	F _x ,F _y (N/V)	F _z ² (N/V)	T _x ,T _y ,T _z (Nm/V)
Omega160	SI-1000-120	±1000	±2500	±120	100	250	12
Omega160	SI-1500-240	±1500	±3750	±240	150	375	24
Omega160	SI-2500-400	±2500	±6250	±400	250	625	40
				Analog Output Range		Analog ±10V Sensitivity ¹	

Notes:

- ±5V Sensitivity values are double the listed ±10V Sensitivity values.
- For IP68 version see caution on physical properties page.

5.17.7 CTL Counts Value

Table 5.113—Counts Value					
Sensor	Calibration	F _x , F _y , F _z (/ lbf)	T _x , T _y , T _z (/ lbf-in)	F _x , F _y , F _z (/ N)	T _x , T _y , T _z (/ Nm)
Omega160	US-200–1000 / SI-1000–120	128	64	32	320
Omega160	US-300–1800 / SI-1500–240	54.4	12.8	16	160
Omega160	US-600–3600 / SI-2500–400	32	16	16	80
Omega160	Tool Transform Factor	See Tool Transform Factor table			
		Counts Value – Standard (US)		Counts Value – Metric (SI)	

5.17.8 Tool Transform Factor

Table 5.114—Tool Transform Factor			
Sensor	Calibration	US (English)	SI (Metric)
Omega160	US-200–1000 / SI-1000–120	0.02 in/lbf	1 mm/N
Omega160	US-300–1800 / SI-1500–240	0.0425 in/lbf	1 mm/N
Omega160	US-600–3600 / SI-2500–400	0.02 in/lbf	2 mm/N

**5.17.9 Omega160 (US Calibration Complex Loading)
 (Includes IP60/IP65/IP68)¹**

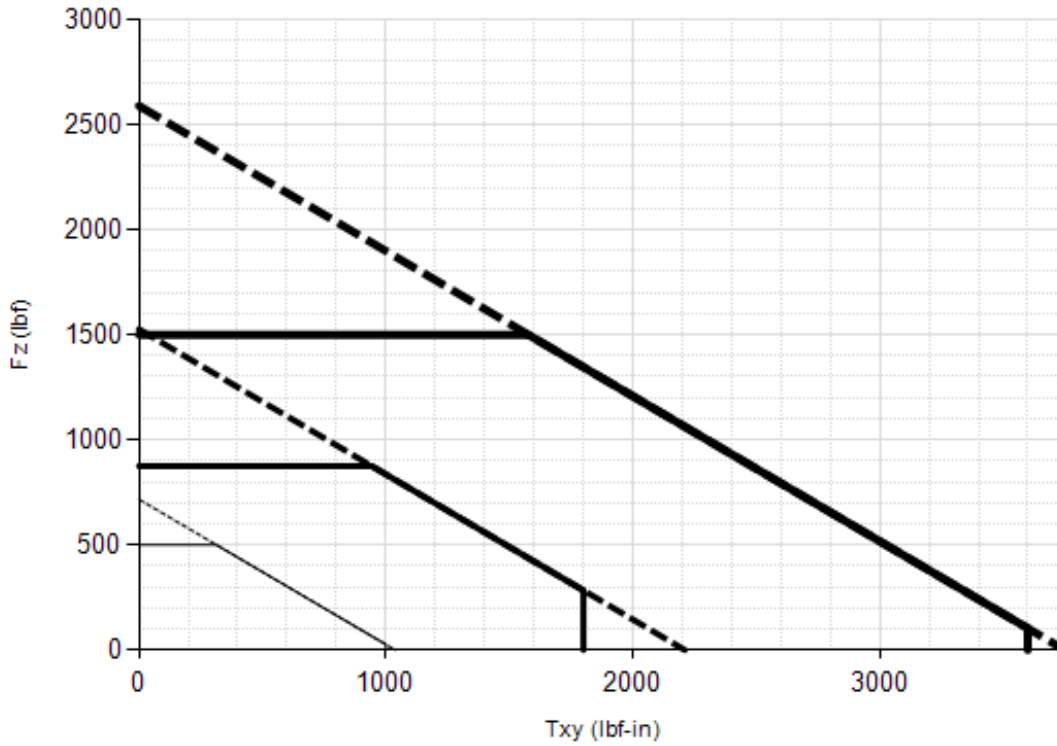
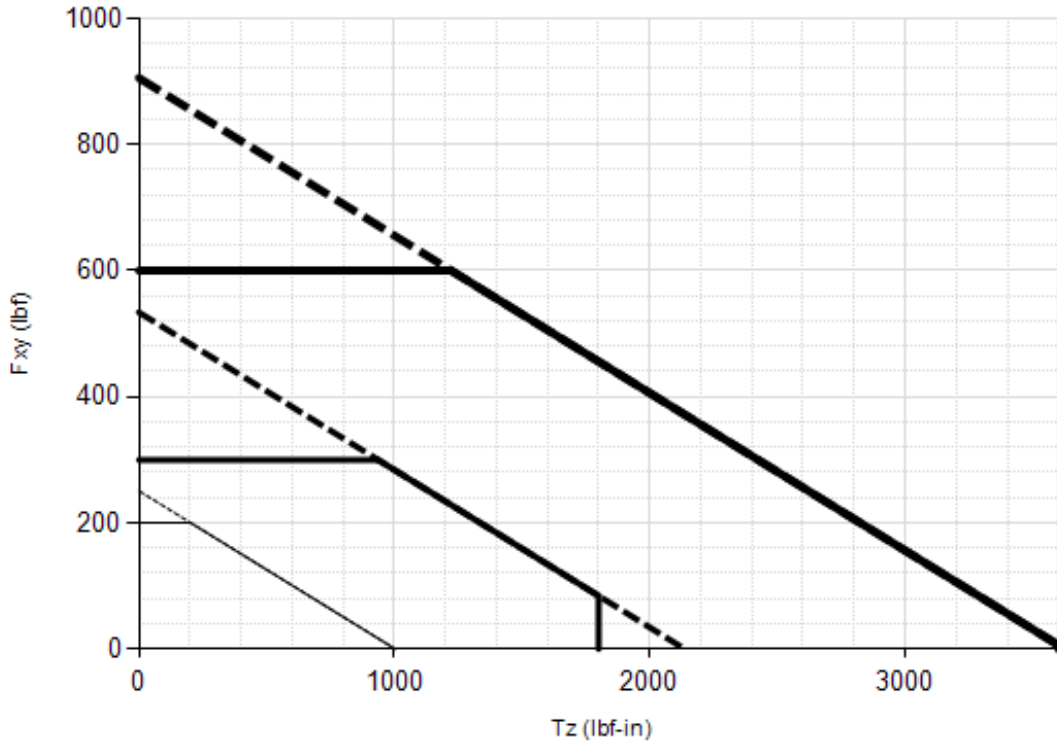

US-200-1000
 US-300-1800
 US-600-3600

Note: 1. For IP68 version see caution on physical properties page.

**5.17.10 Omega160 (SI Calibration Complex Loading)
 (Includes IP60/IP65/IP68)¹**

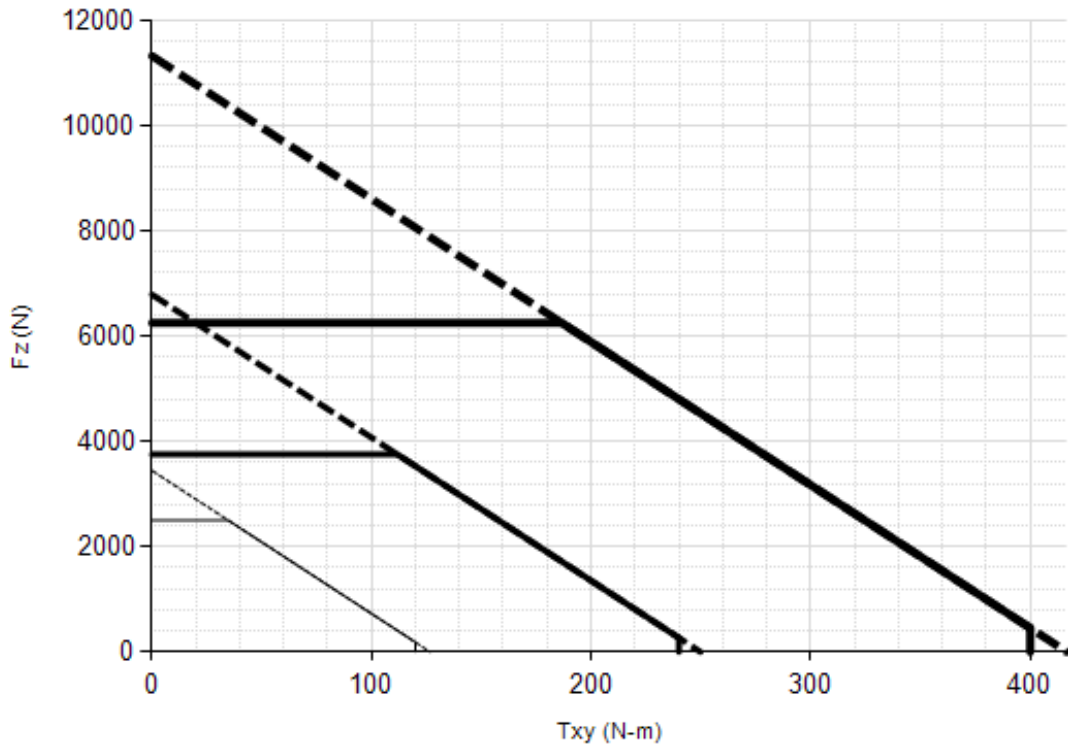
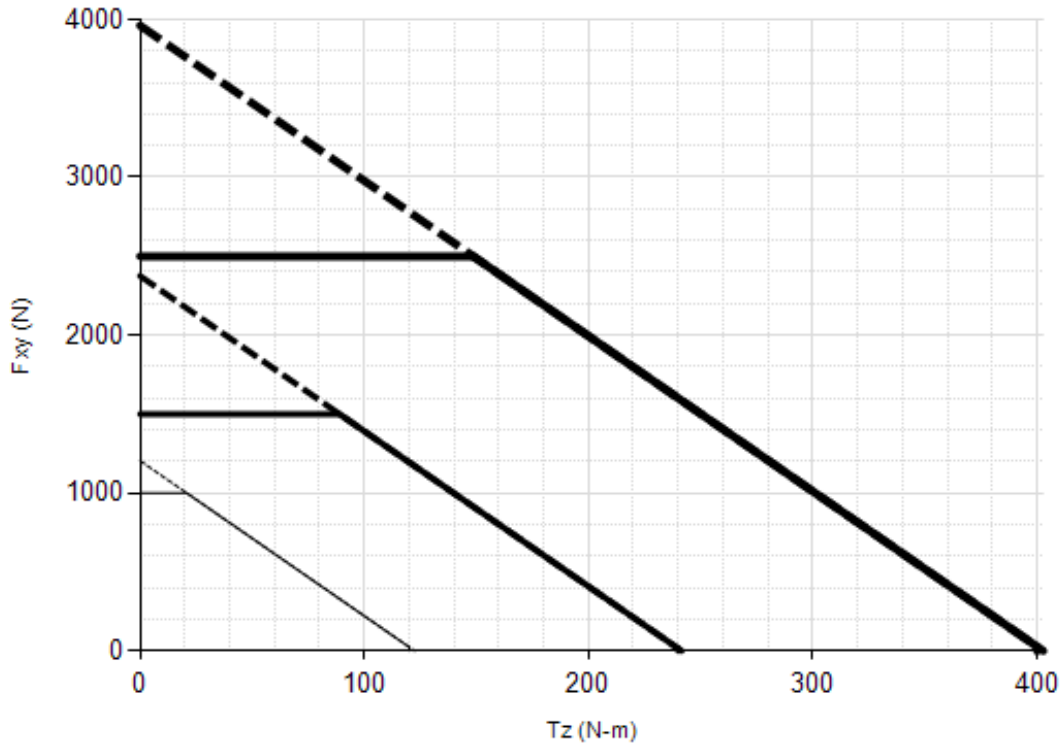

SI-1000-120
 SI-1500-240
 SI-2500-400

Note: 1. For IP68 version see caution on physical properties page.

5.18 Omega190 Specifications

In addition to the information in the following sections, refer to the ATI website:

Table 5.115—Omega190 Drawing and Web Links		
Model	Drawing Part Number	ATI Website Address
Omega190 DAQ/Net	9230-05-1095	https://www.ati-ia.com/products/ft/ft_models.aspx?ID=Omega190

5.18.1 Omega190 Physical Properties

Table 5.116—Omega190 Physical Properties		
Single-Axis Overload	(US) Standard Units	(SI) Metric Units
Fxy	±8000 lbf	±36000 N
Fz	±25000 lbf	±110000 N
Txy	±60000 lbf-in	±6800 Nm
Tz	±60000 lbf-in	±6800 Nm
Stiffness (Calculated)		
X-axis & Y-axis forces (Kx, Ky)	1.4x10 ⁶ lb/in	2.4x10 ⁸ N/m
Z-axis force (Kz)	2.1x10 ⁶ lb/in	3.6x10 ⁸ N/m
X-axis & Y-axis torque (Ktx, Kty)	1.4x10 ⁷ lbf-in/rad	1.5x10 ⁶ Nm/rad
Z-axis torque (Ktz)	2.8x10 ⁷ lbf-in/rad	3.2x10 ⁶ Nm/rad
Resonant Frequency		
Fx, Fy, Tz	N/A	N/A
Fz, Tx, Ty	N/A	N/A
Physical Specifications		
Weight ¹	14 lb	6.35 kg
Diameter ¹	7.48 in	190 mm
Height ¹	2.2 in	55.9 mm
Note:		
1. Specifications include standard interface plates.		

5.18.2 Calibration Specifications (excludes CTL calibrations)

Table 5.117— Omega190 Calibrations (excludes CTL calibrations) ^{1, 2}									
Sensor	(US) Standard Calibration	Fx,Fy (lbf)	Fz ³ (lbf)	Tx,Ty (lbf-in)	Tz (lbf-in)	Fx,Fy (lbf)	Fz ³ (lbf)	Tx,Ty (lbf-in)	Tz (lbf-in)
Omega190	US-400-3000	400	1000	3000	3000	5/64	5/32	15/32	5/16
Omega190	US-800-6000	800	2000	6000	6000	5/32	5/16	15/16	5/8
Omega190	US-1600-12000	1600	4000	12000	12000	5/16	5/8	1 7/8	1 1/4
Sensor	(SI) Metric Calibration	Fx,Fy (N)	Fz ³ (N)	Tx,Ty (Nm)	Tz (Nm)	Fx,Fy (N)	Fz ³ (N)	Tx,Ty (Nm)	Tz (Nm)
Omega190	SI-1800-350	1800	4500	350	350	3/8	3/4	5/96	5/144
Omega190	SI-3600-700	3600	9000	700	700	3/4	1 1/2	5/48	5/72
Omega190	SI-7200-1400	7200	18000	1400	1400	1 1/2	3	5/24	5/36
					Sensing Ranges		Resolution (DAQ, Net F/T) ⁴		

Notes:

1. These system resolutions quoted are the effective resolution after dropping four counts of noise. The effective resolution can be improved with filtering.
2. Applied loads must be within range in each of the six axes for the F/T sensor to measure correctly.
3. For IP68 version see caution on physical properties page.
4. DAQ resolutions are typical for a 16-bit data acquisition system.

5.18.3 CTL Calibration Specifications

Table 5.118— Omega190 CTL Calibrations ^{1, 2}									
Sensor	(US) Standard Calibration	Fx,Fy (lbf)	Fz ³ (lbf)	Tx,Ty (lbf-in)	Tz (lbf-in)	Fx,Fy (lbf)	Fz ³ (lbf)	Tx,Ty (lbf-in)	Tz (lbf-in)
Omega190	US-400-3000	400	1000	3000	3000	5/32	5/16	15/16	5/8
Omega190	US-800-6000	800	2000	6000	6000	5/16	5/8	1 7/8	1 1/4
Omega190	US-1600-12000	1600	4000	12000	12000	5/8	1 1/4	3 3/4	2 1/2
Sensor	(SI) Metric Calibration	Fx,Fy (N)	Fz ³ (N)	Tx,Ty (Nm)	Tz (Nm)	Fx,Fy (N)	Fz ³ (N)	Tx,Ty (Nm)	Tz (Nm)
Omega190	SI-1800-350	1800	4500	350	350	3/4	1 1/2	5/48	5/72
Omega190	SI-3600-700	3600	9000	700	700	1 1/2	3	5/24	5/36
Omega190	SI-7200-1400	7200	18000	1400	1400	3	6	5/12	5/18
					Sensing Ranges		Resolution (Controller)		

Notes:

1. CTL resolutions are typical. System resolutions quoted are the effective resolution after dropping eight counts of noise. The effective resolution can be improved with filtering.
2. Applied loads must be within range in each of the six axes for the F/T sensor to measure correctly.
3. For IP68 version see caution on physical properties page.

5.18.4 CTL Analog Output

Table 5.119— Omega190 Analog Output							
Sensor	(US) Standard Calibration	Fx,Fy (lbf)	Fz ² (lbf)	Tx,Ty,Tz (lbf-in)	Fx,Fy (lbf/V)	Fz ² (lbf/V)	Tx,Ty,Tz (lbf-in/V)
Omega190	US-400-3000	±400	±1000	±3000	40	100	300
Omega190	US-800-6000	±800	±2000	±6000	80	200	600
Omega190	US-1600-12000	±1600	±4000	±12000	160	400	1200
Sensor	(SI) Metric Calibration	Fx,Fy (N)	Fz ² (N)	Tx,Ty,Tz (Nm)	Fx,Fy (N/V)	Fz ² (N/V)	Tx,Ty,Tz (Nm/V)
Omega190	SI-1800-350	±1800	±4500	±350	180	450	35
Omega190	SI-3600-700	±3600	±9000	±700	360	900	70
Omega190	SI-7200-1400	±7200	±18000	±1400	720	1800	140
		Analog Output Range			Analog ±10V Sensitivity¹		

Notes:
 1. ±5V Sensitivity values are double the listed ±10V Sensitivity values.
 2. For IP68 version see caution on physical properties page.

5.18.5 CTL Counts Value

Table 5.120—Counts Value					
Sensor	Calibration	Fx, Fy, Fz (/ lbf)	Tx, Ty, Tz (/ lbf-in)	Fx, Fy, Fz (/ N)	Tx, Ty, Tz (/ Nm)
Omega190	US-400-3000 / SI-1800-350	153.6	307.2	32	230.4
Omega190	US-800-6000 / SI-3600-700	76.8	153.6	16	115.2
Omega190	US-1600-12000 / SI-7200-1400	38.4	76.8	8	57.6
Omega190	Tool Transform Factor	0.005 in/lbf		1.3889 mm/N	
		Counts Value – Standard (US)		Counts Value – Metric (SI)	

5.18.6 Omega190 (US Calibration Complex Loading)

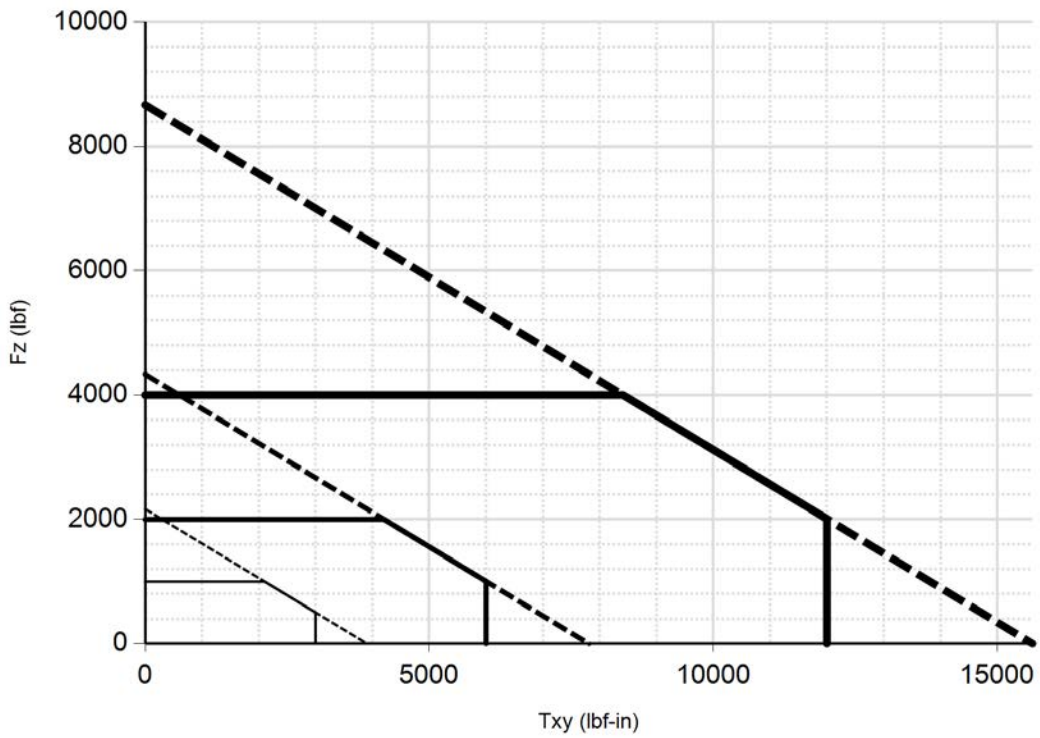
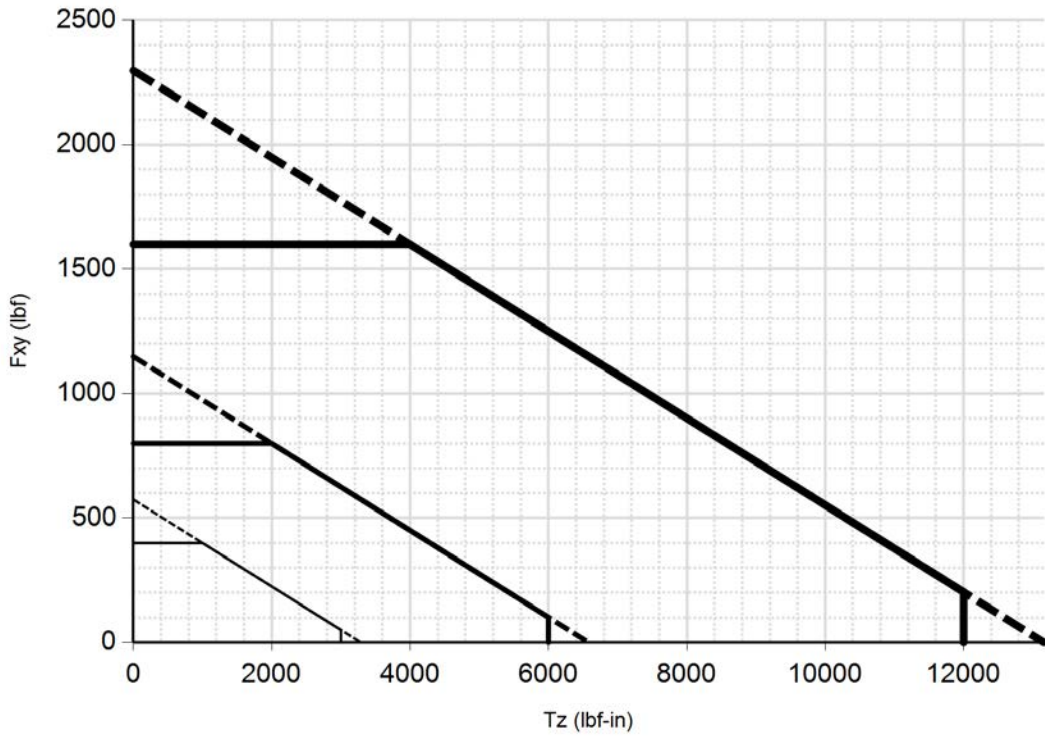

US-400-3000
 US-800-6000
 US-1600-12000

5.18.7 Omega190 (SI Calibration Complex Loading)

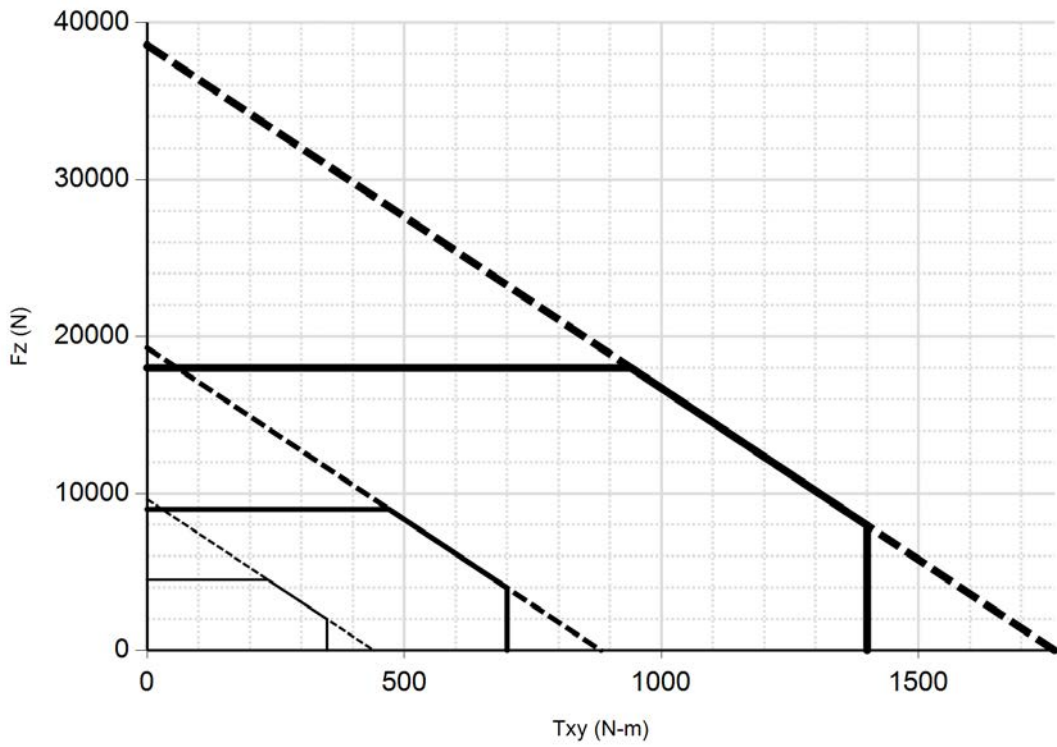
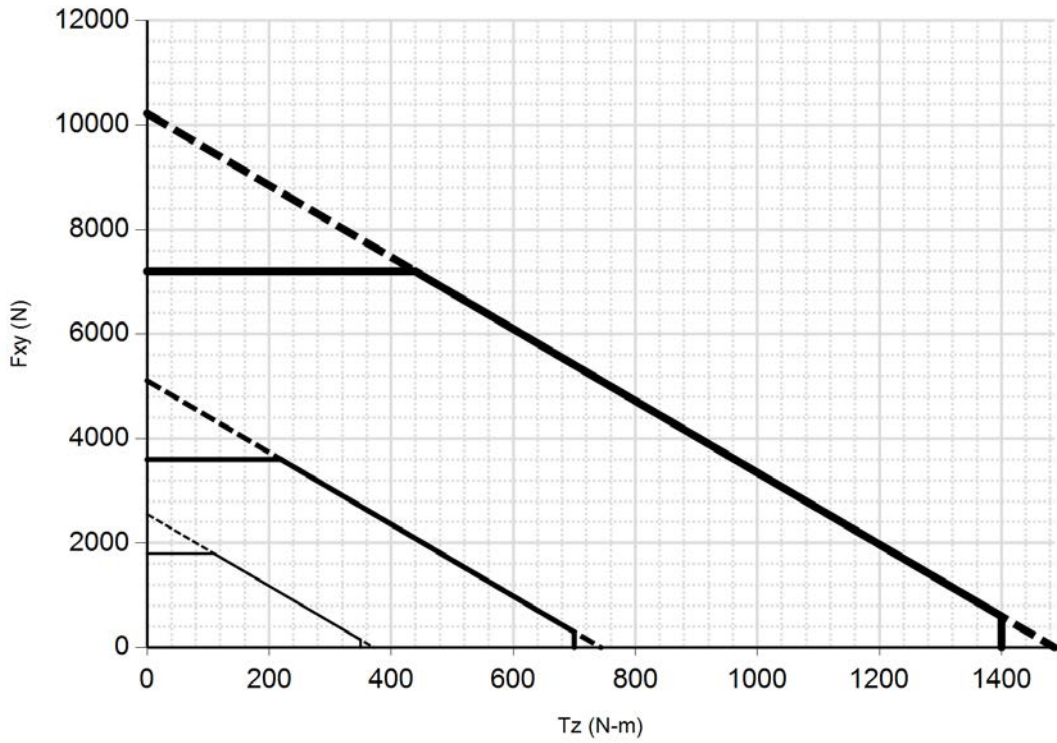

SI-1800-350
 SI-3600-700
 SI-7200-1400

5.19 Omega191 Specifications (Includes IP60/IP65/IP68 Versions)

NOTICE: For transducer versions without a through hole and without an IP rating, use a metallic adapter plate that covers the center hole.

In addition to the information in the following sections, refer to the ATI website:

Table 5.121—Omega191 Drawing and Web Links		
Model	Drawing Part Number	ATI Website Address
Omega191 DAQ/Net	9230-05-1464	https://www.ati-ia.com/products/ft/ft_models.aspx?id=Omega191
Omega191 IP60	9230-05-1470	https://www.ati-ia.com/products/ft/ft_models.aspx?id=Omega191+IP60
Omega191 IP65 Mux ¹ /DAQ/Net	9230-05-1471	https://www.ati-ia.com/products/ft/ft_models.aspx?id=Omega191+IP65%2fIP68
Omega191 IP68 Mux ¹ /DAQ/Net	9230-05-1472	
Note:		
1. Mux transducers are used in F/T Controller systems.		

5.19.1 Omega191 Physical Properties

Table 5.122—Omega191 Physical Properties		
Single-Axis Overload	(US) Standard Units	(SI) Metric Units
Fxy	±8000 lbf	±36000 N
Fz	±25000 lbf	±110000 N
Txy	±60000 inf-lb	±6800 Nm
Tz	±60000 inf-lb	±6800 Nm
Stiffness (Calculated)		
X-axis & Y-axis forces (Kx, Ky)	1.4x10 ⁶ lb/in	2.4x10 ⁸ N/m
Z-axis force (Kz)	2.1x10 ⁶ lb/in	3.6x10 ⁸ N/m
X-axis & Y-axis torque (Ktx, Kty)	1.4x10 ⁷ lbf-in/rad	1.5x10 ⁶ Nm/rad
Z-axis torque (Ktz)	2.8x10 ⁷ lbf-in/rad	3.2x10 ⁶ Nm/rad
Resonant Frequency		
Fx, Fy, Tz	N/A	N/A
Fz, Tx, Ty	N/A	N/A
Physical Specifications		
Weight ¹	20.8 lb	9.41 kg
Diameter ¹	7.48 in	190 mm
Height ¹	2.52 in	64 mm
Note:		
1. Specifications include standard interface plates.		

5.19.2 Omega191 IP60 Physical Properties

Table 5.123—Omega191 IP60 Physical Properties		
Single-Axis Overload	(US) Standard Units	(SI) Metric Units
Fxy	±8000 lbf	±36000 N
Fz	±25000 lbf	±110000 N
Txy	±60000 inf-lb	±6800 Nm
Tz	±60000 inf-lb	±6800 Nm
Stiffness (Calculated)		
X-axis & Y-axis forces (Kx, Ky)	1.4x10 ⁶ lb/in	2.4x10 ⁸ N/m
Z-axis force (Kz)	2.1x10 ⁶ lb/in	3.6x10 ⁸ N/m
X-axis & Y-axis torque (Ktx, Kty)	1.4x10 ⁷ lbf-in/rad	1.5x10 ⁶ Nm/rad
Z-axis torque (Ktz)	2.8x10 ⁷ lbf-in/rad	3.2x10 ⁶ Nm/rad
Resonant Frequency		
Fx, Fy, Tz	1200 Hz	1200 Hz
Fz, Tx, Ty	1200 Hz	1200 Hz
Physical Specifications		
Weight ¹	31 lb	14.1 kg
Diameter ¹	9.37 in	238 mm
Height ¹	2.9 in	73.7 mm
Note: 1. Specifications include standard interface plates.		

5.19.3 Omega191 IP65/IP68 Physical Properties

Table 5.124—Omega191 IP65/IP68 Physical Properties		
Single-Axis Overload	(US) Standard Units	(SI) Metric Units
Fxy	±8000 lbf	±36000 N
Fz	±25000 lbf	±110000 N
Txy	±60000 inf-lb	±6800 Nm
Tz	±60000 inf-lb	±6800 Nm
Stiffness (Calculated)		
X-axis & Y-axis forces (Kx, Ky)	1.4x10 ⁶ lb/in	2.4x10 ⁸ N/m
Z-axis force (Kz)	2.1x10 ⁶ lb/in	3.6x10 ⁸ N/m
X-axis & Y-axis torque (Ktx, Kty)	1.4x10 ⁷ lbf-in/rad	1.5x10 ⁶ Nm/rad
Z-axis torque (Ktz)	2.8x10 ⁷ lbf-in/rad	3.2x10 ⁶ Nm/rad
Resonant Frequency		
Fx, Fy, Tz	1400 Hz	1400 Hz
Fz, Tx, Ty	980 Hz	980 Hz
Physical Specifications		
Weight ¹	29 lb	13.2 kg
Diameter ¹	8.03 in	204 mm
Height ¹	2.94 in	74.8 mm
Note: 1. Specifications include standard interface plates.		



CAUTION: When submerged, IP68 transducers exhibit a decrease in Fz range related to the submersion depth. This loss is the result of pressure-induced preloading on the transducer. The preload can be masked by biasing the transducer at the depth prior to applying the load to be measured. The following estimates are for room temperature fresh water at sea level.

Submersion Depth		
IP68 Omega191	US	Metric
Fz preload at 10 m depth	661 lb	2941 N
Fz preload at other depths	-20 lb/ft x depthInFeet	-294 N/m x depthInMeters

5.19.4 Calibration Specifications (excludes CTL calibrations)

Table 5.125— Omega191 Calibrations (excludes CTL calibrations) ^{1, 2}										
Sensor	(US) Standard Calibration	Fx,Fy (lbf)	Fz ³ (lbf)	Tx,Ty (lbf-in)	Tz (lbf-in)	Fx,Fy (lbf)	Fz ³ (lbf)	Tx,Ty (lbf-in)	Tz (lbf-in)	
Omega191	US-400-3000	400	1000	3000	3000	5/64	5/32	15/32	5/16	
Omega191	US-800-6000	800	2000	6000	6000	5/32	5/16	15/16	5/8	
Omega191	US-1600-12000	1600	4000	12000	12000	5/16	5/8	1 7/8	1 1/4	
Sensor	(SI) Metric Calibration	Fx,Fy (N)	Fz ³ (N)	Tx,Ty (Nm)	Tz (Nm)	Fx,Fy (N)	Fz ³ (N)	Tx,Ty (Nm)	Tz (Nm)	
Omega191	SI-1800-350	1800	4500	350	350	3/8	3/4	5/96	5/144	
Omega191	SI-3600-700	3600	9000	700	700	3/4	1 1/2	5/48	5/72	
Omega191	SI-7200-1400	7200	18000	1400	1400	1 1/2	3	5/24	5/36	
					Sensing Ranges	Resolution (DAQ, Net F/T) ⁴				

Notes:

1. These system resolutions quoted are the effective resolution after dropping four counts of noise. The effective resolution can be improved with filtering.
2. Applied loads must be within range in each of the six axes for the F/T sensor to measure correctly.
3. For IP68 version see caution on physical properties page.
4. DAQ resolutions are typical for a 16-bit data acquisition system.

5.19.5 CTL Calibration Specifications

Table 5.126— Omega191 CTL Calibrations ^{1, 2}										
Sensor	(US) Standard Calibration	Fx,Fy (lbf)	Fz ³ (lbf)	Tx,Ty (lbf-in)	Tz (lbf-in)	Fx,Fy (lbf)	Fz ³ (lbf)	Tx,Ty (lbf-in)	Tz (lbf-in)	
Omega191	US-400-3000	400	1000	3000	3000	5/32	5/16	15/16	5/8	
Omega191	US-800-6000	800	2000	6000	6000	5/16	5/8	1 7/8	1 1/4	
Omega191	US-1600-12000	1600	4000	12000	12000	5/8	1 1/4	3 3/4	2 1/2	
Sensor	(SI) Metric Calibration	Fx,Fy (N)	Fz ³ (N)	Tx,Ty (Nm)	Tz (Nm)	Fx,Fy (N)	Fz ³ (N)	Tx,Ty (Nm)	Tz (Nm)	
Omega191	SI-1800-350	1800	4500	350	350	3/4	1 1/2	5/48	5/72	
Omega191	SI-3600-700	3600	9000	700	700	1 1/2	3	5/24	5/36	
Omega191	SI-7200-1400	7200	18000	1400	1400	3	6	5/12	5/18	
					Sensing Ranges	Resolution (Controller)				

Notes:

1. CTL resolutions are typical. System resolutions quoted are the effective resolution after dropping eight counts of noise. The effective resolution can be improved with filtering.
2. Applied loads must be within range in each of the six axes for the F/T sensor to measure correctly.
3. For IP68 version see caution on physical properties page.

5.19.6 CTL Analog Output

Table 5.127— Omega191 Analog Output							
Sensor	(US) Standard Calibration	Fx,Fy (lbf)	Fz ² (lbf)	Tx,Ty,Tz (lbf-in)	Fx,Fy (lbf/V)	Fz ² (lbf/V)	Tx,Ty,Tz (lbf-in/V)
Omega191	US-400-3000	±400	±1000	±3000	40	100	300
Omega191	US-800-6000	±800	±2000	±6000	80	200	600
Omega191	US-1600-12000	±1600	±4000	±12000	160	400	1200
Sensor	(SI) Metric Calibration	Fx,Fy (N)	Fz ² (N)	Tx,Ty,Tz (Nm)	Fx,Fy (N/V)	Fz ² (N/V)	Tx,Ty,Tz (Nm/V)
Omega191	SI-1800-350	±1800	±4500	±350	180	450	35
Omega191	SI-3600-700	±3600	±9000	±700	360	900	70
Omega191	SI-7200-1400	±7200	±18000	±1400	720	1800	140
				Analog Output Range		Analog ±10V Sensitivity ¹	

Notes:

- ±5V Sensitivity values are double the listed ±10V Sensitivity values.
- For IP68 version see caution on physical properties page.

5.19.7 CTL Counts Value

Table 5.128—Counts Value					
Sensor	Calibration	Fx, Fy, Fz (/ lbf)	Tx, Ty, Tz (/ lbf-in)	Fx, Fy, Fz (/ N)	Tx, Ty, Tz (/ Nm)
Omega191	US-400-3000 / SI-1800-350	153.6	307.2	32	230.4
Omega191	US-800-6000 / SI-3600-700	76.8	153.6	16	115.2
Omega191	US-1600-12000 / SI-7200-1400	38.4	76.8	8	57.6
Omega191	Tool Transform Factor	0.005 in/lbf		1.3889 mm/N	
		Counts Value – Standard (US)		Counts Value – Metric (SI)	

**5.19.8 Omega191 (US Calibration Complex Loading)
 (Includes IP60/IP65/IP68)¹**

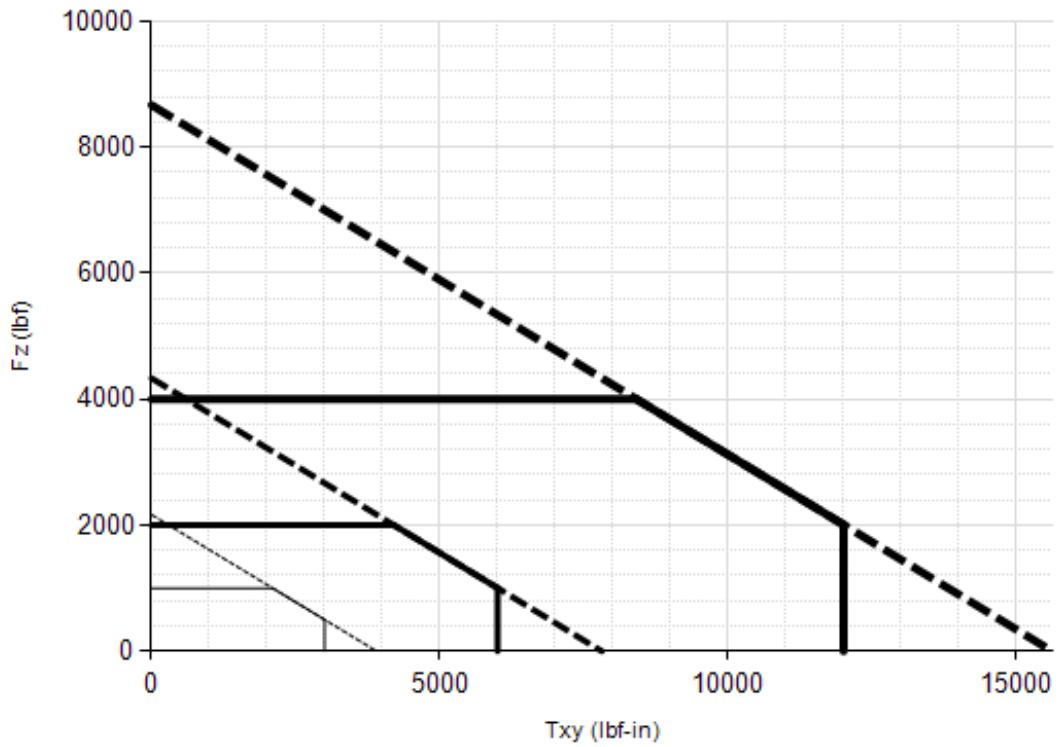
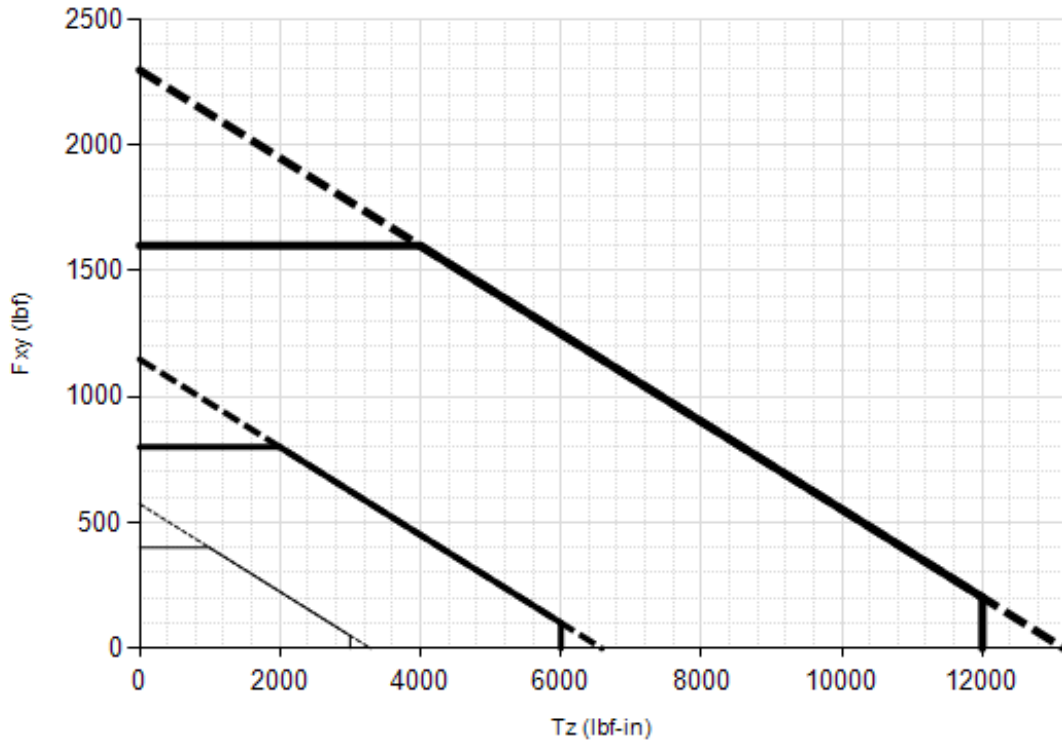

US-400-3000
 US-800-6000
 US-1600-12000

Note: 1. For IP68 version see caution on physical properties page.

**5.19.9 Omega191 (SI Calibration Complex Loading)
 (Includes IP60/IP65/IP68)¹**

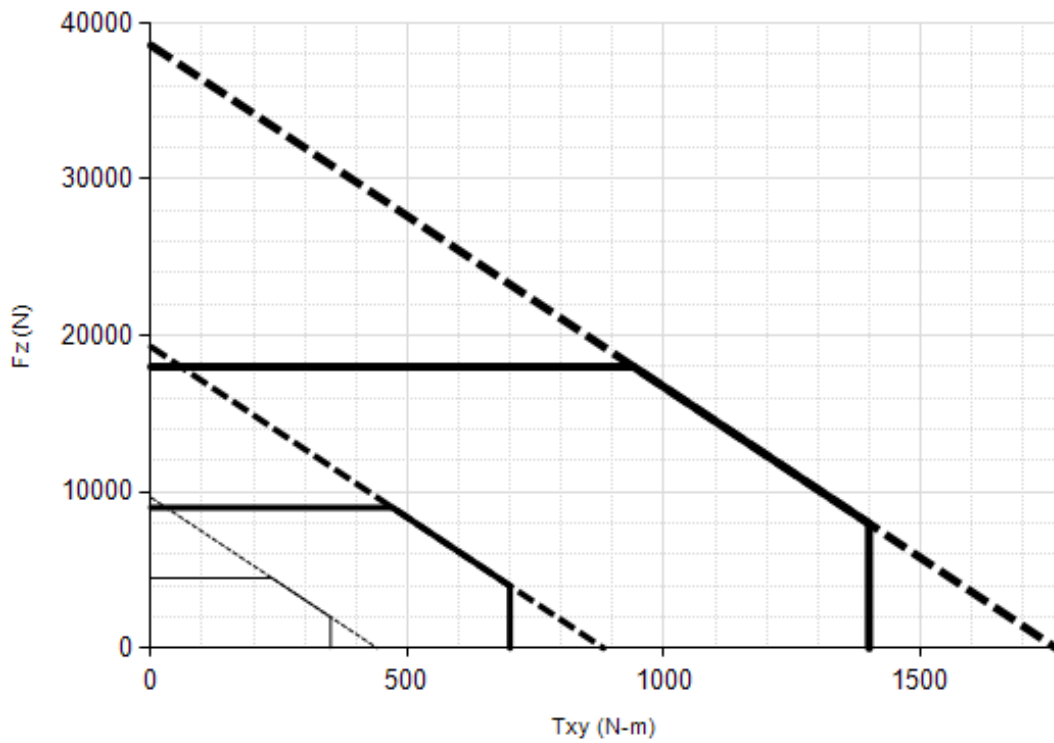
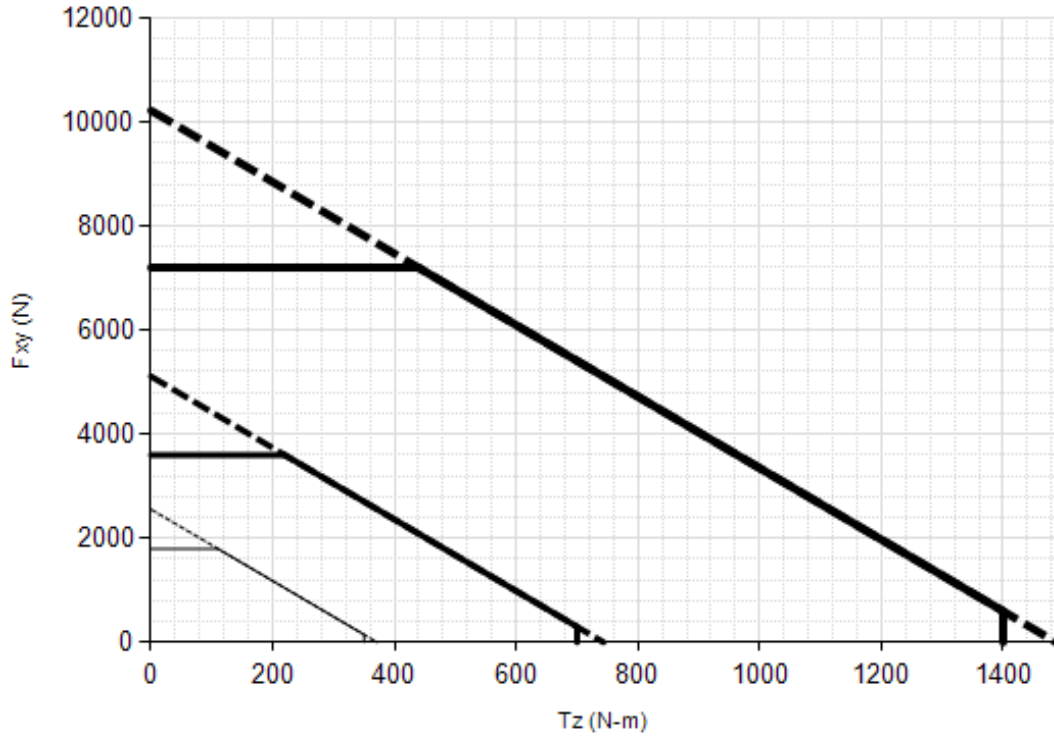

SI-1800-350
 SI-3600-700
 SI-7200-1400

Note: 1. For IP68 version see caution on physical properties page.

5.20 Omega250 Specifications (Includes IP60/IP65/IP68)

In addition to the information in the following sections, refer to the ATI website:

Model	Drawing Part Number	ATI Website Address
Omega250 DAQ/Net	9230-05-1468	https://www.ati-ia.com/products/ft/ft_models.aspx?id=Omega250+IP60
Omega250 IP60	9230-05-1266	
Omega250 IP65	9230-05-1271	https://www.ati-ia.com/products/ft/ft_models.aspx?id=Omega250+IP65%2fIP68
Omega250 IP68-10 m	9230-05-1276	

5.20.1 Omega250 Physical Properties (Includes IP60/IP65/IP68)

Single-Axis Overload	(US) Standard Units	(SI) Metric Units
Fxy	±37000 lbf	±160000 N
Fz	±74000 lbf	±330000 N
Txy	±180000 inf-lb	±21000 Nm
Tz	±220000 inf-lb	±25000 Nm
Stiffness (Calculated)		
X-axis & Y-axis forces (Kx, Ky)	2.4x10 ⁶ lb/in	4.2x10 ⁸ N/m
Z-axis force (Kz)	3.2x10 ⁶ lb/in	5.6x10 ⁸ N/m
X-axis & Y-axis torque (Ktx, Kty)	2.7x10 ⁷ lbf-in/rad	3.0x10 ⁶ Nm/rad
Z-axis torque (Ktz)	5.5x10 ⁷ lbf-in/rad	6.2x10 ⁶ Nm/rad
Resonant Frequency		
Fx, Fy, Tz	780 Hz	780 Hz
Fz, Tx, Ty	770 Hz	770 Hz
Physical Specifications		
Weight ¹	70 lb	31.8 kg
Diameter ¹	11.6 in	295 mm
Height ¹	3.74 in	94.9 mm
Note: 1. Specifications include standard interface plates.		



CAUTION: When submerged, IP68 transducers exhibit a decrease in Fz range related to the submersion depth. This loss is the result of pressure-induced preloading on the transducer. The preload can be masked by biasing the transducer at the depth prior to applying the load to be measured. The following estimates are for room temperature fresh water at sea level.

Submersion Depth		
IP68 Omega250	US	Metric
Fz preload at 10 m depth	-1138 lb	-5061 N
Fz preload at other depths	-35 lb/ft × depthInFeet	-506 N/m × depthInMeters

5.20.2 Calibration Specifications (excludes CTL calibrations)

Table 5.131— Omega250 Calibrations (excludes CTL calibrations) ^{1, 2}									
Sensor	(US) Standard Calibration	Fx,Fy (lbf)	Fz ³ (lbf)	Tx,Ty (lbf-in)	Tz (lbf-in)	Fx,Fy (lbf)	Fz ³ (lbf)	Tx,Ty (lbf-in)	Tz (lbf-in)
Omega250	US-900-4500	900	1800	4500	4500	1/2	1/2	1	1
Omega250	US-1800-9000	1800	3600	9000	9000	1	1	2	2
Omega250	US-3600-18000	3600	7200	18000	18000	2	2	5	5
Sensor	(SI) Metric Calibration	Fx,Fy (N)	Fz ³ (N)	Tx,Ty (Nm)	Tz (Nm)	Fx,Fy (N)	Fz ³ (N)	Tx,Ty (Nm)	Tz (Nm)
Omega250	SI-4000-500	4000	8000	500	500	1	2	1/8	1/8
Omega250	SI-8000-1000	8000	16000	1000	1000	2	4	1/4	1/4
Omega250	SI-16000-2000	16000	32000	2000	2000	4	8	1/2	1/2
Sensing Ranges						Resolution (DAQ, Net F/T)⁴			

Notes:

1. These system resolutions quoted are the effective resolution after dropping four counts of noise. The effective resolution can be improved with filtering.
2. Applied loads must be within range in each of the six axes for the F/T sensor to measure correctly.
3. For IP68 version see caution on physical properties page.
4. DAQ resolutions are typical for a 16-bit data acquisition system.

5.20.3 CTL Calibration Specifications

Table 5.132— Omega250 CTL Calibrations ^{1, 2}									
Sensor	(US) Standard Calibration	Fx,Fy (lbf)	Fz ³ (lbf)	Tx,Ty (lbf-in)	Tz (lbf-in)	Fx,Fy (lbf)	Fz ³ (lbf)	Tx,Ty (lbf-in)	Tz (lbf-in)
Omega250	US-900-4500	900	1800	4500	4500	1	1	2	2
Omega250	US-1800-9000	1800	3600	9000	9000	2	2	5	5
Omega250	US-3600-18000	3600	7200	18000	18000	5	5	10	10
Sensor	(SI) Metric Calibration	Fx,Fy (N)	Fz ³ (N)	Tx,Ty (Nm)	Tz (Nm)	Fx,Fy (N)	Fz ³ (N)	Tx,Ty (Nm)	Tz (Nm)
Omega250	SI-4000-500	4000	8000	500	500	2	4	1/4	1/4
Omega250	SI-8000-1000	8000	16000	1000	1000	4	8	1/2	1/2
Omega250	SI-16000-2000	16000	32000	2000	2000	8	16	1	1
Sensing Ranges						Resolution (Controller)			

Notes:

1. CTL resolutions are typical. System resolutions quoted are the effective resolution after dropping eight counts of noise. The effective resolution can be improved with filtering.
2. Applied loads must be within range in each of the six axes for the F/T sensor to measure correctly.
3. For IP68 version see caution on physical properties page.

5.20.4 CTL Analog Output

Table 5.133— Omega250 Analog Output							
Sensor	(US) Standard Calibration	F _x ,F _y (lbf)	F _z ² (lbf)	T _x ,T _y ,T _z (lbf-in)	F _x ,F _y (lbf/V)	F _z ² (lbf/V)	T _x ,T _y ,T _z (lbf-in/V)
Omega250	US-900-4500	±900	±1800	±4500	90	180	450
Omega250	US-1800-9000	±1800	±3600	±9000	180	360	900
Omega250	US-3600-18000	±3600	±7200	±18000	360	720	1800
Sensor	(SI) Metric Calibration	F _x ,F _y (N)	F _z ² (N)	T _x ,T _y ,T _z (Nm)	F _x ,F _y (N/V)	F _z ² (N/V)	T _x ,T _y ,T _z (Nm/V)
Omega250	SI-4000-500	±4000	±8000	±500	400	800	50
Omega250	SI-8000-1000	±8000	±16000	±1000	800	1600	100
Omega250	SI-16000-2000	±16000	±32000	±2000	1600	3200	200
Analog Output Range					Analog ±10V Sensitivity¹		

Notes:

1. ±5V Sensitivity values are double the listed ±10V Sensitivity values.
2. For IP68 version see caution on physical properties page.

5.20.5 CTL Counts Value

Table 5.134—Counts Value					
Sensor	Calibration	F _x , F _y , F _z (/ lbf)	T _x , T _y , T _z (/ lbf-in)	F _x , F _y , F _z (/ N)	T _x , T _y , T _z (/ Nm)
Omega250	US-900–4500 / SI-4000–500	8	4	4000	32000
Omega250	US-1800–9000 / SI-8000–1000	4	2	2000	16000
Omega250	US-3600–18000 / SI-16000–2000	2	1	1000	8000
Omega250	Tool Transform Factor	0.02 in/lbf		1.25 mm/N	
Counts Value – Standard (US)			Counts Value – Metric (SI)		

**5.20.6 Omega250 (US Calibration Complex Loading)
 (Includes IP60/IP65/IP68)¹**

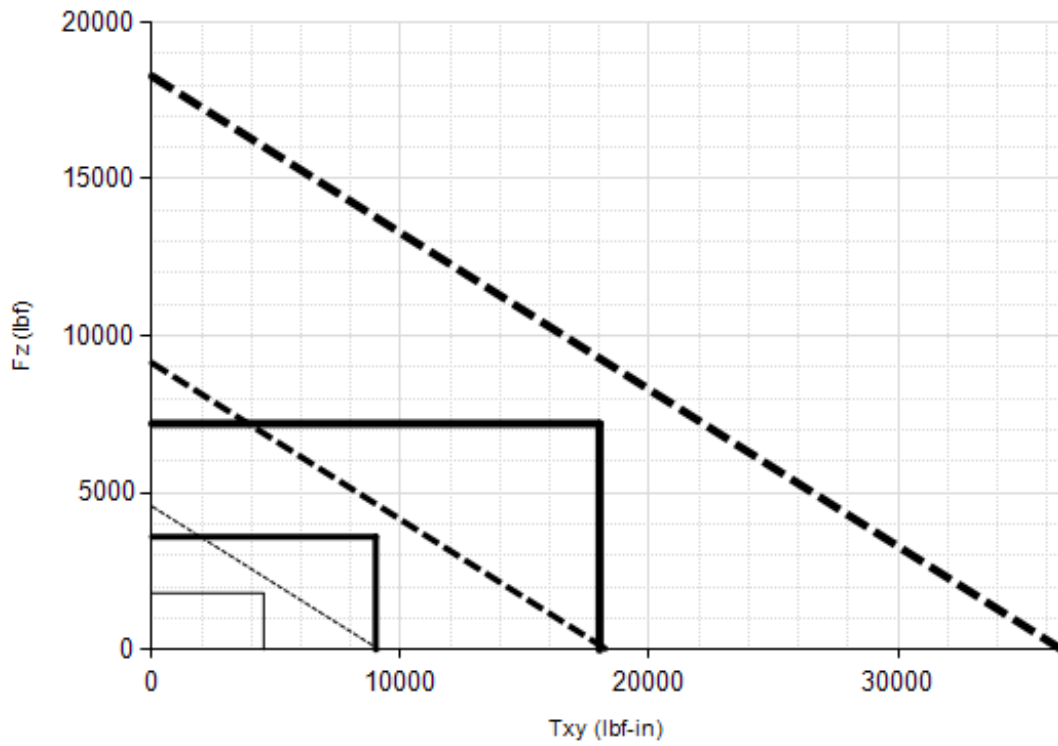
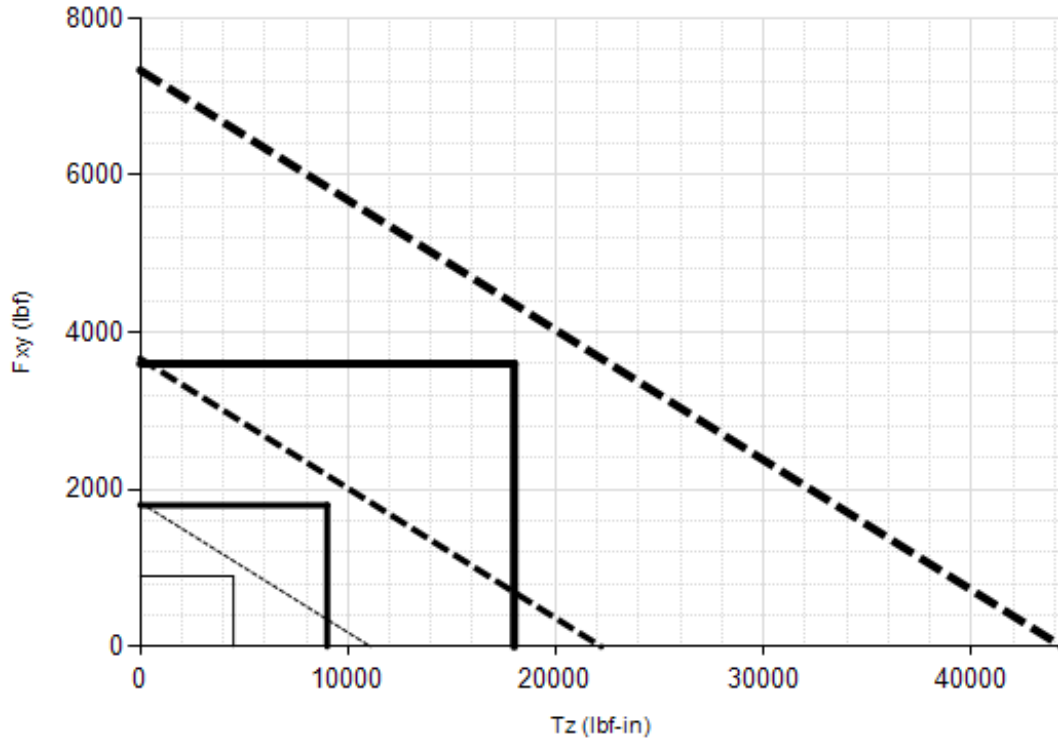

US-900-4500
 US-1800-9000
 US-3600-18000

Note: 1. For IP68 version see caution on physical properties page.

**5.20.7 Omega250 (SI Calibration Complex Loading)
 (Includes IP60/IP65/IP68)¹**

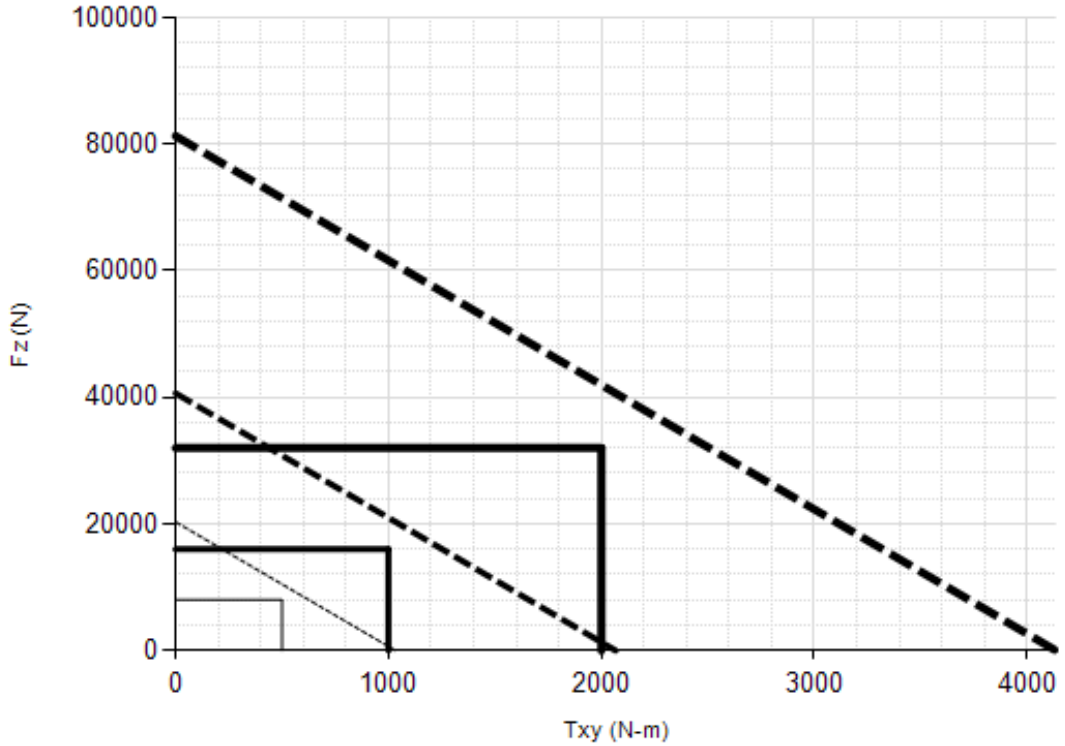
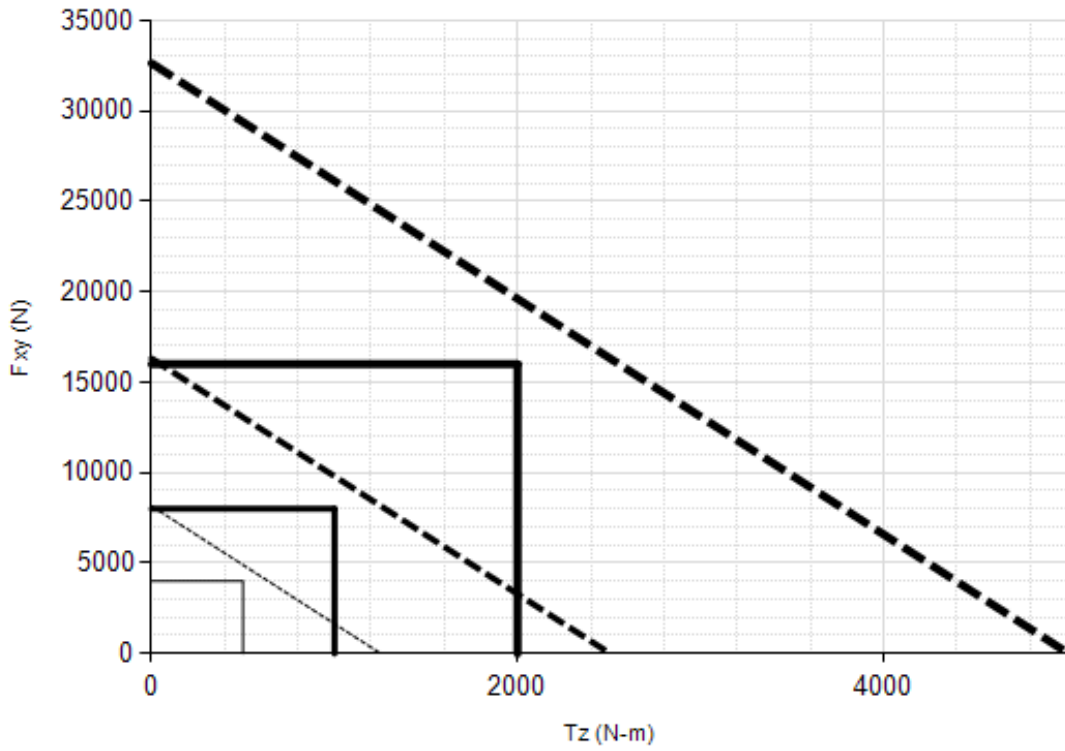

SI-4000-500
 SI-8000-1000
 SI-16000-2000

Note: 1. For IP68 version see caution on physical properties page.

5.21 Omega331 Specifications (Includes IP65)

In addition to the information in the following sections, refer to the ATI website:

Table 5.135—Omega331 Drawing and Web Links		
Model	Drawing Part Number	ATI Website Address
Omega331	9230-05-1158	https://www.ati-ia.com/products/ft/ft_models.aspx?id=Omega331
Omega331 IP65	9230-05-1360	

5.21.1 Omega331 Physical Properties (Includes IP65)

Table 5.136—Omega331 Physical Properties (Includes IP60/IP65)		
Single-Axis Overload	(US) Standard Units	(SI) Metric Units
Fxy	±53000 lbf	±240000 N
Fz	±120000 lbf	±520000 N
Txy	±280000 inf-lb	±32000 Nm
Tz	±320000 inf-lb	±36000 Nm
Stiffness (Calculated)		
X-axis & Y-axis forces (Kx, Ky)	6.9x10 ⁶ lb/in	1.2x10 ⁹ N/m
Z-axis force (Kz)	7.3x10 ⁶ lb/in	1.3x10 ⁹ N/m
X-axis & Y-axis torque (Ktx, Kty)	8.1x10 ⁷ lbf-in/rad	9.2x10 ⁶ Nm/rad
Z-axis torque (Ktz)	2.1x10 ⁸ lbf-in/rad	2.4x10 ⁷ Nm/rad
Resonant Frequency		
Fx, Fy, Tz	N/A	N/A
Fz, Tx, Ty	N/A	N/A
Physical Specifications		
Weight ¹	104 lb	47 kg
Diameter ¹	13 in	330 mm
Height ¹	4.22 in	107 mm
Note: 1. Specifications include standard interface plates.		

5.21.2 Calibration Specifications (excludes CTL calibrations)

Table 5.137— Omega331 Calibrations (excludes CTL calibrations)1, 2									
Sensor	(US) Standard Calibration	Fx,Fy (lbf)	Fz (lbf)	Tx,Ty (lbf-in)	Tz (lbf-in)	Fx,Fy (lbf)	Fz (lbf)	Tx,Ty (lbf-in)	Tz (lbf-in)
Omega331	US-2250-13000	2250	5250	13000	13000	3/8	1	3 3/4	1 7/8
Omega331	US-4500-26000	4500	10500	26000	26000	3/4	2	7 1/2	3 3/4
Omega331	US-9000-52000	9000	21000	52000	52000	1 1/2	4	15	7 1/2
Sensor	(SI) Metric Calibration	Fx,Fy (kN)	Fz (kN)	Tx,Ty (kNm)	Tz (kNm)	Fx,Fy (kN)	Fz (kN)	Tx,Ty (kNm)	Tz (kNm)
Omega331	SI-10000-1500	10	22	1.5	1.5	1/640	1/240	3/8000	3/16000
Omega331	SI-20000-3000	20	44	3	3	1/320	1/120	3/4000	3/8000
Omega331	SI-40000-6000	40	88	6	6	1/160	1/60	3/2000	3/4000
Sensing Ranges						Resolution (DAQ, Net F/T)³			

Notes:

1. These system resolutions quoted are the effective resolution after dropping four counts of noise. The effective resolution can be improved with filtering.
2. Applied loads must be within range in each of the six axes for the F/T sensor to measure correctly.
3. DAQ resolutions are typical for a 16-bit data acquisition system.

5.21.3 CTL Calibration Specifications

Table 5.138— Omega331 CTL Calibrations1, 2									
Sensor	(US) Standard Calibration	Fx,Fy (lbf)	Fz (lbf)	Tx,Ty (lbf-in)	Tz (lbf-in)	Fx,Fy (lbf)	Fz (lbf)	Tx,Ty (lbf-in)	Tz (lbf-in)
Omega331	US-2250-13000	2250	5250	13000	13000	3/4	2	7 1/2	3 3/4
Omega331	US-4500-26000	4500	10500	26000	26000	1 1/2	4	15	7 1/2
Omega331	US-9000-52000	9000	21000	52000	52000	3	8	30	15
Sensor	(SI) Metric Calibration	Fx,Fy (kN)	Fz (kN)	Tx,Ty (kNm)	Tz (kNm)	Fx,Fy (kN)	Fz (kN)	Tx,Ty (kNm)	Tz (kNm)
Omega331	SI-10000-1500	10	22	1.5	1.5	1/320	1/120	3/4000	3/8000
Omega331	SI-20000-3000	20	44	3	3	1/160	1/60	3/2000	3/4000
Omega331	SI-40000-6000	40	88	6	6	1/80	1/30	3/1000	3/2000
Sensing Ranges						Resolution (Controller)			

Notes:

1. CTL resolutions are typical. System resolutions quoted are the effective resolution after dropping eight counts of noise. The effective resolution can be improved with filtering.
2. Applied loads must be within range in each of the six axes for the F/T sensor to measure correctly.

5.21.4 CTL Analog Output

Table 5.139— Omega331 Analog Output							
Sensor	(US) Standard Calibration	Fx,Fy (lbf)	Fz (lbf)	Tx,Ty,Tz (lbf-in)	Fx,Fy (lbf/V)	Fz (lbf/V)	Tx,Ty,Tz (lbf-in/V)
Omega331	US-2250-13000	±2250	±5250	±13000	225	525	1300
Omega331	US-4500-26000	±4500	±10500	±26000	450	1050	2600
Omega331	US-9000-52000	±9000	±21000	±52000	900	2100	5200
Sensor	(SI) Metric Calibration	Fx,Fy (kN)	Fz (kN)	Tx,Ty,Tz (kNm)	Fx,Fy (kN/V)	Fz (kN/V)	Tx,Ty,Tz (kNm/V)
Omega331	SI-10000-1500	±10	±22	±1.5	1	2.2	0.15
Omega331	SI-20000-3000	±20	±44	±3	2	4.4	0.3
Omega331	SI-40000-6000	±40	±88	±6	4	8.8	0.6
					Analog Output Range		Analog ±10V Sensitivity¹

Notes:
 1. ±5V Sensitivity values are double the listed ±10V Sensitivity values.

5.21.5 CTL Counts Value

Table 5.140—Counts Value					
Sensor	Calibration	Fx, Fy, Fz (/ lbf)	Tx, Ty, Tz (/ lbf-in)	Fx, Fy, Fz (/ kN)	Tx, Ty, Tz (/ kNm)
Omega331	US-2250–13000 / SI-10000–1500	32	6.4	7680	64000
Omega331	US-4500–26000 / SI-20000–3000	16	3.2	3840	32000
Omega331	US-9000–52000 / SI-40000–6000	8	1.6	1920	16000
Omega331	Tool Transform Factor	0.05 in/lbf		1.2 mm/N	
		Counts Value – Standard (US)		Counts Value – Metric (SI)	

5.21.6 Omega331 (US Calibration Complex Loading) (Includes IP65)

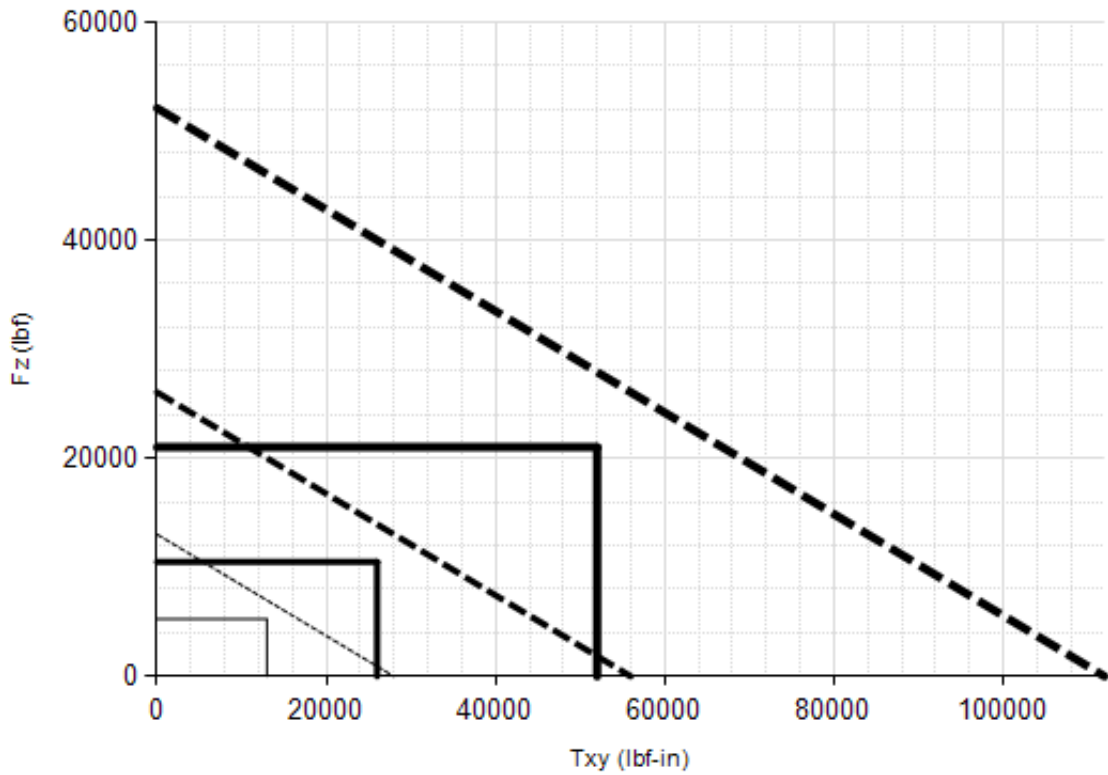
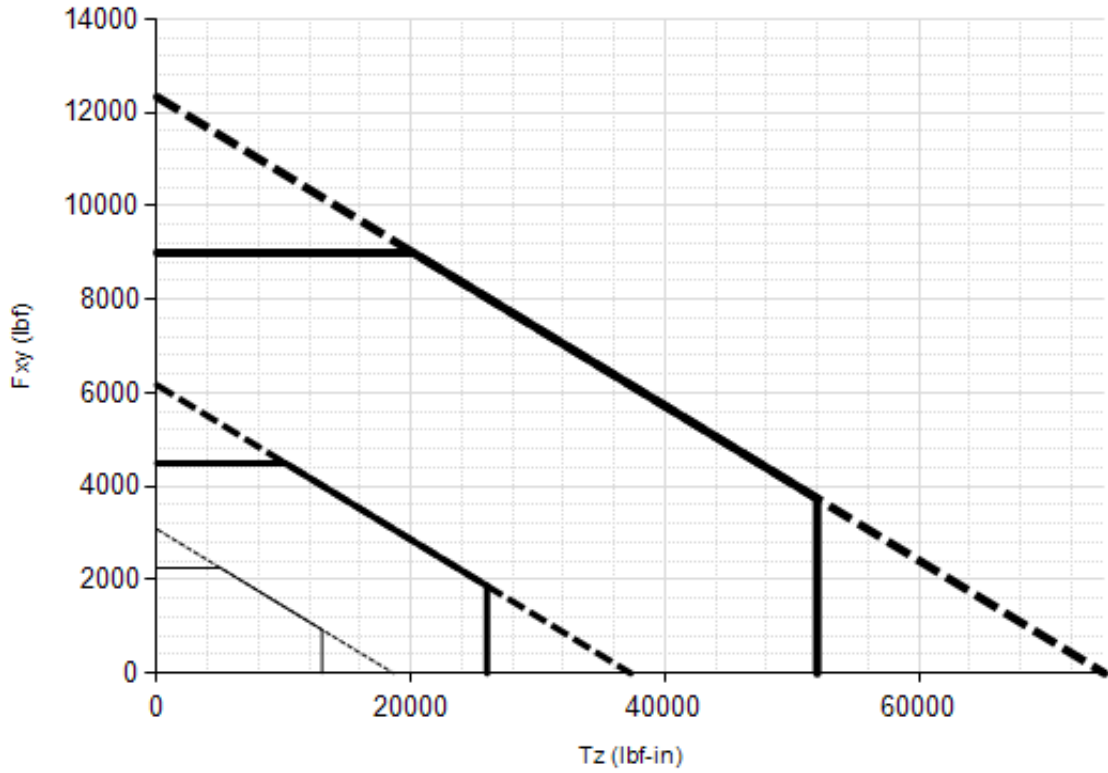

US-2250-13000
 US-4500-26000
 US-9000-52000

5.21.7 Omega331 (SI Calibration Complex Loading) (Includes IP65)

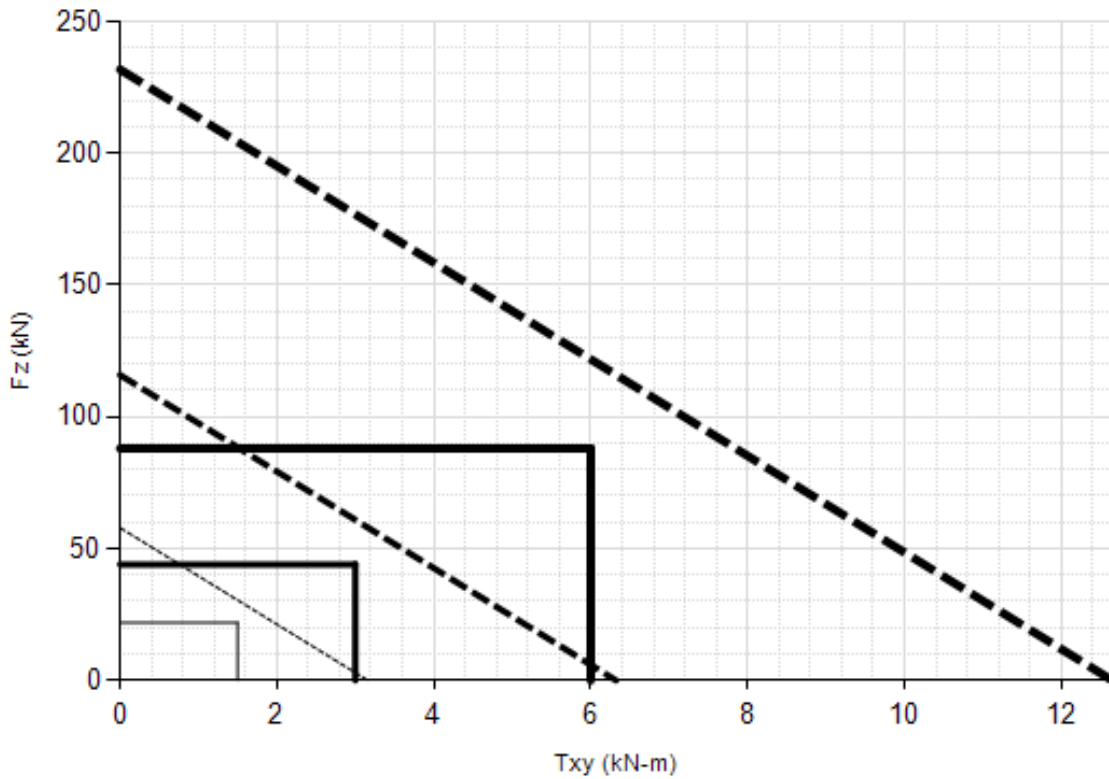
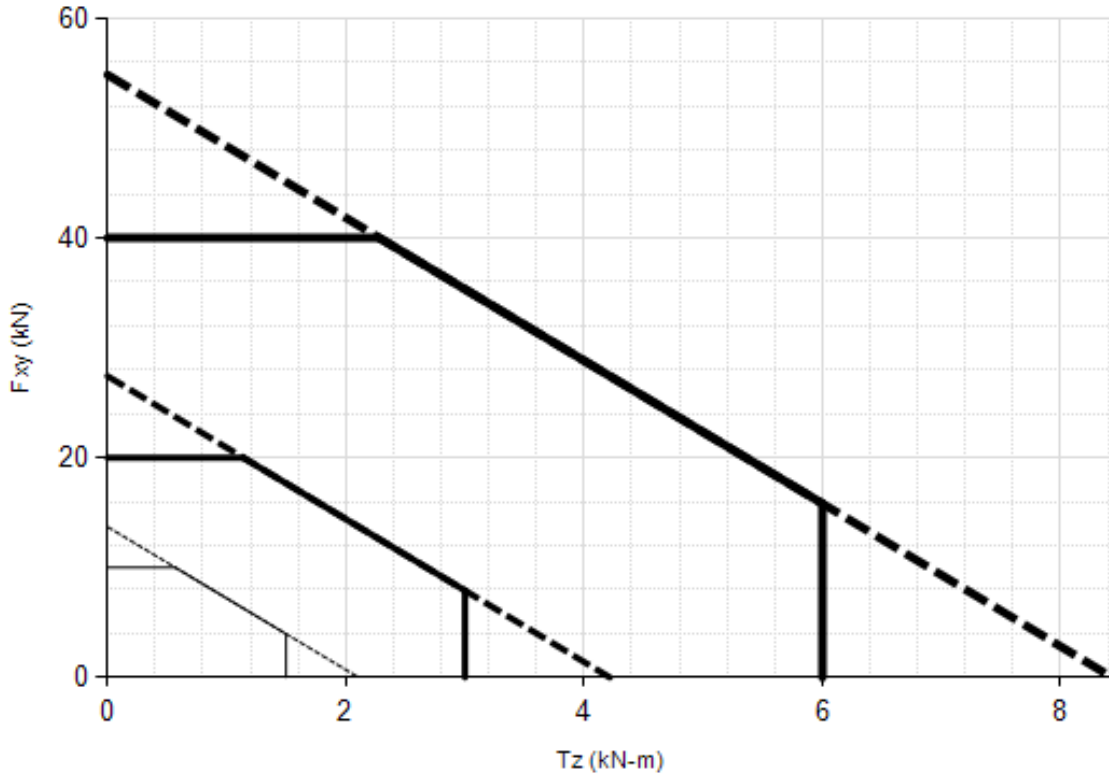

SI-10000-1500
 SI-20000-3000
 SI-40000-6000

6. Diagnostics and Maintenance

6.1 Reducing Noise

6.1.1 Mechanical Vibration

In many cases, perceived noise is actually a real fluctuation of force and/or torque. This fluctuation is caused by vibrations in the tooling or the robot arm. Many F/T systems offer filtering or averaging that can smooth out noise. If this is not sufficient, consider adding a digital filter to the application software.

6.1.2 Electrical Interference

If interference by motors or other noise-generating equipment is observed, check the F/T's ground connections.

If sufficient grounding is not possible or does not reduce the noise, consider using averaging or filtering.

6.2 Detecting Failures (Diagnostics)

6.2.1 Detecting Sensitivity Changes

Sensitivity checking of the transducer can also be used to measure the transducer system's health. Apply known loads to the transducer and verifying the system output matches the known loads, for example: a transducer mounted to a robot arm may have an end-effector attached to it. If the end-effector has moving parts, they must be moved in a known position.

This check is done by completing the following steps:

1. Place the robot arm in an orientation that allows the gravity load from the end-effector to exert load on many transducer output axes.
2. Record the output readings.
3. Position the robot arm to apply another load (this time causing the outputs to move far from the earlier readings).
4. Record the second set of output readings.
5. Find the differences from the first and second set of readings, and use it as the sensitivity value.

Even if the values vary somewhat from sample set to sample set, they can be used to detect gross errors. Either the resolved outputs or the raw transducer voltages may be used (the same must be used for all steps of this process).



CAUTION: When any strain gage is saturated or otherwise inoperable, **all transducer F/T readings are invalid**. It is vitally important to monitor for these conditions.

6.3 Scheduled Maintenance

6.3.1 Periodic Inspection

For most applications, there are no parts that need to be replaced during normal operation. With industrial-type applications that continuously or frequently move the system's cabling, you should periodically check the cable jacket for signs of wear. These applications should implement the procedures discussed in *Section 6.2—Detecting Failures (Diagnostics)* to detect any failures.

Transducers that are not IP60, IP65, or IP68 rated must be kept free of excessive dust, debris, or moisture. IP60-rated transducers must be kept free of excessive moisture. Debris and dust should be kept from accumulating on or in a transducer.

6.3.2 Periodic Calibration

Periodic calibration of the transducer and its electronics is required to maintain traceability to national standards. Follow any applicable ISO-9000-type standards for calibration. ATI Industrial Automation recommends annual recalibrations, especially for applications that frequently cycle the loads applied to the transducer.

6.4 A Note on Servicing Transducer Cabling

6.4.1 Calibrations

In many cases the transducer cable comprises part of the calibrated transducer. In these cases, changing the length or type of the cable can affect the calibration. When making cabling changes, check with ATI Industrial Automation to ensure the system's calibration is not be affected.

6.4.2 Cabling and Connectors

The transducer cables and connectors are not designed to be serviced by users, for example: the high flex life stranding in the cables is difficult to service and if improperly assembled, the stranding fails.

However, in some cases, users may need to temporarily remove the connector on a cable that is permanently attached to a transducer such as Nano and Mini models. When reattaching the wires to the connector, encase each conductor in heat shrink tubing at the connection to prevent premature fatiguing of the mechanical connection. Also, exactly reconnect any components contained in the connector; otherwise, improper service impacts system performance and accuracy.

To prevent transducer damage, ensure the cable jacketing is in proper condition. Damage to the outer jacketing of the transducer cable enables moisture or water to enter an otherwise sealed transducer.

6.5 Resolution

ATI's transducers have a three sensing beam configuration where the three beams are equally spaced around a central hub and attached to the outside wall of the transducer. This three beam configuration transfers applied loads to multiple sensing beams. Also if a counterpart axis has reduced, this configuration allows the transducer to increase its sensing range in a given axis.

The resolution of each transducer axis depends on how the applied load is spread among the sensing beams. The best resolution occurs when the quantization of the gages is evenly distributed as load is applied. In the worst case scenario, the discrete value of all involved gages increases at the same time.

F/T resolutions are specified as typical resolution which is the average of the worst and best case scenarios. Because both multi-gage effects can be modeled as a normal distribution, this value represents the most commonly perceived, average resolution. Although this misrepresents the actual performance of the transducers, it results in a close (and always conservative) estimate.

7. Terms and Conditions of Sale

The following Terms and Conditions are a supplement to and include a portion of ATI's Standard Terms and Conditions, which are on file at ATI and available upon request.

ATI warrants to Purchaser that force torque sensor products purchased hereunder will be free from defects in material and workmanship under normal use for a period of one year from the date of shipment. This warranty does not cover components subject to wear and tear under normal usage or those requiring periodic replacement. ATI will have no liability under this warranty unless: (a) ATI is given written notice of the claimed defect and a description thereof within thirty (30) days after Purchaser discovers the defect and in any event not later than the last day of the warranty period; and (b) the defective item is received by ATI not later ten (10) days after the last day of the warranty period. ATI's entire liability and Purchaser's sole remedy under this warranty is limited to repair or replacement, at ATI's election, of the defective part or item or, at ATI's election, refund of the price paid for the item. The foregoing warranty does not apply to any defect or failure resulting from improper installation, operation, maintenance or repair by anyone other than ATI.

ATI will in no event be liable for incidental, consequential or special damages of any kind, even if ATI has been advised of the possibility of such damages. ATI's aggregate liability will in no event exceed the amount paid by purchaser for the item which is the subject of claim or dispute. ATI will have no liability of any kind for failure of any equipment or other items not supplied by ATI.

No action against ATI, regardless of form, arising out of or in any way connected with products or services supplied hereunder may be brought more than one year after the cause of action accrued.

No representation or agreement varying or extending the warranty and limitation of remedy provisions contained herein is authorized by ATI, and may not be relied upon as having been authorized by ATI, unless in writing and signed by an executive officer of ATI.

Unless otherwise agreed in writing by ATI, all designs, drawings, data, inventions, software and other technology made or developed by ATI in the course of providing products and services hereunder, and all rights therein under any patent, copyright or other law protecting intellectual property, shall be and remain ATI's property. The sale of products or services hereunder does not convey any express or implied license under any patent, copyright or other intellectual property right owned or controlled by ATI, whether relating to the products sold or any other matter, except for the license expressly granted below.

In the course of supplying products and services hereunder, ATI may provide or disclose to Purchaser confidential and proprietary information of ATI relating to the design, operation or other aspects of ATI's products. As between ATI and Purchaser, ownership of such information, including without limitation any computer software provided to Purchaser by ATI, shall remain in ATI and such information is licensed to Purchaser only for Purchaser's use in operating the products supplied by ATI hereunder in Purchaser's internal business operations.

Without ATI's prior written permission, Purchaser will not use such information for any other purpose or provide or otherwise make such information available to any third party. Purchaser agrees to take all reasonable precautions to prevent any unauthorized use or disclosure of such information.

Purchaser will not be liable hereunder with respect to disclosure or use of information which: (a) is in the public domain when received from ATI; (b) is thereafter published or otherwise enters the public domain through no fault of Purchaser; (c) is in Purchaser's possession prior to receipt from ATI; (d) is lawfully obtained by Purchaser from a third party entitled to disclose it; or (f) is required to be disclosed by judicial order or other governmental authority, provided that, with respect to such required disclosures, Purchaser gives ATI prior notice thereof and uses all legally available means to maintain the confidentiality of such information.