



Force/Torque (F/T) Manual

Introduction

This manual is a compilation of several modular manual sections for an F/T sensor system. The modular manual sections are in the following order and provide the following information:

A. Introduction

This section includes contact information to reach an ATI representative, general safety guidelines, and terms and conditions of sale. The ATI document number for this modular manual section is: 9620-05-A-Introduction.

A comprehensive glossary of terms is here: https://www.ati-ia.com/library/Glossary_of_Robotic_Terminology.aspx.

B. Sensor

This section contains information about the sensor mechanical body.

Content includes a product overview, installation instructions, operation information, preventative maintenance guidance, troubleshooting guidelines, and specifications.

The ATI document number for this modular manual section is: 9620-05-B-XX (XX = sensor model name).

C. Communication Interface Version

This section contains information about the electrical and software features of a specific communication interface version. Examples of communication interface versions are EtherCAT, Ethernet, and RS422. This section also includes cable information.

The ATI document number for this modular manual section is: 9620-05-C-XX (XX = communication interface version).

D. Custom Application

This section contains additional information needed for the sensor system to work within a custom application.

The ATI document number for this modular manual section is: 9620-05-D-XX (XX = custom application).

Engineered Products for Robotic Productivity

Pinnacle Park • 1031 Goodworth Drive • Apex, NC 27539 USA • Tel: +1.919.772.0115 • Fax: +1.919.772.8259 • www.ati-ia.com

A. Introduction

Please contact ATI Industrial Automation with any questions concerning a particular model.



WARNING: Only use ATI products for applications approved by the manufacturer. Using ATI products in applications other than what was intended by the manufacturer could result in damage to equipment and injury to personnel.



CAUTION: This manual describes the function, application, and safety considerations of this product. This manual must be read and understood before any attempt is made to install or operate the product, otherwise damage to the product or unsafe conditions may occur.

Information contained in this document is the property of ATI Industrial Automation, Inc. (ATI) and shall not be reproduced in whole or in part without prior written approval of ATI. The information herein is subject to change without notice. This manual is periodically revised to reflect and incorporate changes made to the product.

The information contained herein is confidential and reserved exclusively for the customers and authorized agents of ATI Industrial Automation and may not be divulged to any third party without prior written consent from ATI. No warranty including implied warranties is made with regard to accuracy of this document or fitness of this device for a particular application. ATI Industrial Automation shall not be liable for any errors contained in this document or for any incidental or consequential damages caused thereby. ATI Industrial Automation also reserves the right to make changes to this manual at any time without prior notice.

ATI assumes no responsibility for any errors or omissions in this document.

Copyright © (2022) by ATI Industrial Automation. All rights reserved.

Note:

Please read the manual before calling customer service, and have the following information available:

1. Serial number, for example: FT01234
2. Model, for example: Axia130-M125
3. Calibration, for example: SI-800-50 or SI-2000-125
4. Accurate and complete description of the question or concern
5. Computer and software information, for example: operating system, PC type, drivers, and application software

Be near the F/T system when calling (if possible).

Please contact an ATI representative for assistance, if needed:

Sale, Service and Information about ATI products:

ATI Industrial Automation

1031 Goodworth Drive

Apex, NC 27539 USA

www.ati-ia.com

Tel: +1.919.772.0115

Fax: +1.919.772.8259

Application Engineering

Tel: +1.919.772.0115, Extension 511

Fax: +1.919.772.8259

E-mail: ft.support@novanta.com

24/7 Support: +1 855 ATI-IA 00 (+1 855-284-4200)

1. Safety

The safety section describes general safety guidelines to be followed with this product, explanations of the notifications found in this manual, and safety precautions that apply to the product. Product specific notifications are imbedded within the sections of this manual (where they apply).

1.1 Explanation of Notifications

These notifications are used in all of ATI manuals and are not specific to this product. The user should heed all notifications from the robot manufacturer and/or the manufacturers of other components used in the installation.



DANGER: Notification of information or instructions that if not followed will result in death or serious injury. The notification provides information about the nature of the hazardous situation, the consequences of not avoiding the hazard, and the method for avoiding the situation.



WARNING: Notification of information or instructions that if not followed could result in death or serious injury. The notification provides information about the nature of the hazardous situation, the consequences of not avoiding the hazard, and the method for avoiding the situation.



CAUTION: Notification of information or instructions that if not followed could result in moderate injury or will cause damage to equipment. The notification provides information about the nature of the hazardous situation, the consequences of not avoiding the hazard, and the method for avoiding the situation.

NOTICE: Notification of specific information or instructions about maintaining, operating, installing, or setting up the product that if not followed could result in damage to equipment. The notification can emphasize, but is not limited to: specific grease types, best operating practices, and maintenance tips.

1.2 General Safety Guidelines

The customer should verify that the sensor selected is rated for maximum loads and torques expected during operation. Because static forces are less than the dynamic forces from the acceleration or deceleration of the robot, be aware of the dynamic loads caused by the robot.

2. Terms and Conditions of Sale

The following Terms and Conditions are a supplement to and include a portion of ATI's Standard Terms and Conditions, which are on file at ATI and available upon request.

ATI warrants to Purchaser that robotic Tool Changer products purchased hereunder will be free from defects in material and workmanship under normal use for a period of three (3) years from the date of shipment. The warranty period for repairs made under a Return Merchandise Authorization (RMA) shall be for the duration of the original warranty, or ninety (90) days from the date of repaired product shipment, whichever is longer. ATI will have no liability under this warranty unless: (a) ATI is given written notice of the claimed defect and a description thereof within thirty (30) days after Purchaser discovers the defect and in any event not later than the last day of the warranty period; and (b) the defective item is received by ATI not later ten (10) days after the last day of the warranty period. ATI's entire liability and Purchaser's sole remedy under this warranty is limited to repair or replacement, at ATI's election, of the defective part or item or, at ATI's election, refund of the price paid for the item. The foregoing warranty does not apply to any defect or failure resulting from improper installation, operation, maintenance or repair by anyone other than ATI.

ATI will in no event be liable for incidental, consequential or special damages of any kind, even if ATI has been advised of the possibility of such damages. ATI's aggregate liability will in no event exceed the amount paid by Purchaser for the item which is the subject of claim or dispute. ATI will have no liability of any kind for failure of any equipment or other items not supplied by ATI.

No action against ATI, regardless of form, arising out of or in any way connected with products or services supplied hereunder may be brought more than one (1) year after the cause of action accrued.

No representation or agreement varying or extending the warranty and limitation of remedy provisions contained herein is authorized by ATI, and may not be relied upon as having been authorized by ATI, unless in writing and signed by an executive officer of ATI.

Unless otherwise agreed in writing by ATI, all designs, drawings, data, inventions, software and other technology made or developed by ATI in the course of providing products and services hereunder, and all rights therein under any patent, copyright or other law protecting intellectual property, shall be and remain ATI's property. The sale of products or services hereunder does not convey any express or implied license under any patent, copyright or other intellectual property right owned or controlled by ATI, whether relating to the products sold or any other matter except for the license expressly granted below.

In the course of supplying products and services hereunder, ATI may provide or disclose to Purchaser confidential and proprietary information of ATI relating to the design, operation or other aspects of ATI's products. As between ATI and Purchaser, ownership of such information, including without limitation any computer software provided to Purchaser by ATI, shall remain in ATI and such information is licensed to Purchaser only for Purchaser's use in operating the products supplied by ATI hereunder in Purchaser's internal business operations.

Without ATI's prior written permission, Purchaser will not use such information for any other purpose or provide or otherwise make such information available to any third party. Purchaser agrees to take all reasonable precautions to prevent any unauthorized use or disclosure of such information.

Purchaser will not be liable hereunder with respect to disclosure or use of information which: (a) is in the public domain when received from ATI; (b) is thereafter published or otherwise enters the public domain through no fault of Purchaser; (c) is in Purchaser's possession prior to receipt from ATI; (d) is lawfully obtained by Purchaser from a third party entitled to disclose it; or (f) is required to be disclosed by judicial order or other governmental authority, provided that, with respect to such required disclosures, Purchaser gives ATI prior notice thereof and uses all legally available means to maintain the confidentiality of such information.



Axia90 F/T Sensor Manual



Document #: 9620-05-B-Axia90

Engineered Products for Robotic Productivity

Pinnacle Park • 1031 Goodworth Drive • Apex, NC 27539 • Tel:+1 919.772.0115 • Fax:+1 919.772.8259 • www.ati-ia.com

Foreword

Information contained in this document is the property of ATI Industrial Automation, Inc. and shall not be reproduced in whole or in part without prior written approval of ATI Industrial Automation, Inc. The information herein is subject to change without notice and should not be construed as a commitment on the part of ATI Industrial Automation, Inc. This manual is periodically revised to reflect and incorporate changes made to the F/T system.

ATI Industrial Automation, Inc. assumes no responsibility for any errors or omissions in this document.

Copyright © (2023) by ATI Industrial Automation, Inc., Apex, North Carolina USA. All Rights Reserved.
Published in the USA.

ATI F/T Sensing Systems are considered components/ semi-finished goods intended for use in larger system/
device/ finished good.

In consideration that ATI Industrial Automation, Inc. (ATI) products are intended for use with robotic and/or automated machines, ATI does not recommend the use of its products for applications wherein failure or malfunction of a ATI component or system threatens life or makes injury probable. Anyone who uses or incorporates ATI components within any potentially life threatening system must obtain ATI's prior consent based upon assurance to ATI that a malfunction of ATI's component does not pose direct or indirect threat of injury or death, and (even if such consent is given) shall indemnify ATI from any claim, loss, liability, and related expenses arising from any injury or death resulting from use of ATI components.

All trademarks belong to their respective owners.

Note:

Please read the manual before calling customer service, and have the following information available:

1. Serial number (e.g., FT01234)
2. Sensor model (e.g., Axia90-M50)
3. Calibration (e.g., US-15-50, SI-65-6, etc.)
4. Accurate and complete description of the question or problem
5. Computer and software information (operating system, PC type, drivers, application software, and other relevant information about the application's configuration)

Be near the F/T system when calling (if possible).

Please contact an ATI representative for assistance, if needed:

Sale, Service and Information about ATI products:

ATI Industrial Automation

1031 Goodworth Drive
Apex, NC 27539 USA
www.ati-ia.com
Tel: +1.919.772.0115
Fax: +1.919.772.8259

Application Engineering

Tel: +1.919.772.0115, Extension 511
Fax: +1.919.772.8259
E-mail: ft.support@novanta.com

24/7 Support: +1 855 ATI-IA 00 (+1 855-284-4200)

Table of Contents

Glossary	B-4
1. Safety.....	B-6
1.1 Explanation of Notifications.....	B-6
1.2 General Safety Guidelines.....	B-6
1.3 Safety Precautions.....	B-7
2. Product Overview.....	B-8
3. Installation	B-10
3.1 Interface Plates.....	B-10
3.2 Routing the Cable.....	B-12
3.3 Cable Kits.....	B-15
3.4 Install the Sensor	B-16
3.5 Remove the Sensor.....	B-18
3.6 Accuracy Check Procedure.....	B-19
3.7 Detecting Sensitivity Changes.....	B-20
4. Operation	B-21
4.1 Sensor Environment	B-21
4.2 Tool Transformation.....	B-22
4.2.1 Avoid Overloading the Sensor During Tool Transformation.....	B-24
4.2.2 Tool Transformation Functionality Through a Communication Interface	B-24
5. Maintenance.....	B-24
5.1 Periodic Inspection	B-24
5.2 Periodic Calibrating	B-24
6. Troubleshooting	B-25
6.1 Basic Guidance for Troubleshooting	B-26
7. Specifications	B-29
7.1 Environmental Conditions.....	B-29
7.2 Electrical Specifications	B-29
7.3 Calibration Range.....	B-29
7.4 Default Peak Values	B-29
8. Terms and Conditions of Sale.....	B-30

Glossary

Term	Definition
Bias	Biasing is useful for eliminating the effects of gravity (tool weight) or other acting forces. When the bias function is used, the software collects data for the forces and torques that are currently acting on the sensor and use these readings as a reference for future readings. Future readings will have this reference subtracted from them before they are transmitted. Bias may also be referred to as “zero out” or “tare” the sensor.
Calibration	Defines a specific measurement or sensing range for a given sensor. Calibration is also the process of measuring a transducer’s raw response to loads and creating data used in converting the response to forces and torques.
Complex Loading	Any load that is not purely in one axis.
Communication Interface Versions	The software standard that the customer device uses to apply features to the sensor and for the sensor to report data, for example: EtherCAT, RS422, and Ethernet.
Coordinate Frame	See Sensing Reference Frame Origin.
Data Rate	How fast data can be output over a network.
Force	A force is a push or pull action on an object caused by an interaction with another object. Force = mass x acceleration.
FS	Full-Scale, refers to the limits of a given calibration or sensing range.
F/T	Force/Torque.
F_{xy}	The resultant force vector comprised of components F_x and F_y .
Hysteresis	A source of measurement error caused by the residual effects of previously applied loads.
Interface Plate	A separate plate that attaches the sensor to another surface. Interface plates are often used if the bolt pattern on the sensor doesn’t match the bolt pattern on the robot arm or customer tooling. The interface plate has two bolt patterns, one on either side of the plate. One side is for the sensor. The other side is for the robot arm or customer tooling.
IP67	Ingress protection rating “67” designates protection against dust and submersion under 1 m of fresh water.
Master Device	A customer supplied device such as a personal computer, robot, or programmable logic controller (PLC) that is compatible a specific communication interface.
Measurement Uncertainty	Commonly referred to as “accuracy”, “measurement uncertainty” is the worst-case error between the measured value and the true load. The measurement uncertainty is specified as a percentage of the full-scale measurement range for a given sensor model and calibration size. This value takes into account multiple sources of error. The sensor’s calibration certificate lists the measurement uncertainty percentage. For more information, refer to <i>Section 2.2: Measurement Uncertainty</i> in the Frequently Asked Questions (FAQ) document located at: https://www.ati-ia.com/library/documents/FT_FAQ.pdf .
Mechanical Coupling	When an external object such as customer tooling or utilities contacts a sensor’s surface between the sensor’s mounting side and tool side.
Mounting Interface Plate	An interface plate that attaches the sensor to a fixed surface like a robot arm.
N/A	Not Applicable
Overload	The condition where more load is applied to the transducer than it can measure. This will result in saturation.

Term	Definition
P/N	Part Number
Power Cycle	When a user removes and then restores power to a device.
Resolution	The smallest change in load that can be measured. Resolution is usually much smaller than accuracy.
Sample Rate	How fast the ADCs are sampling inside the unit.
Saturation	The condition where the transducer or data acquisition hardware has a load or signal outside of its sensing range.
Sensing Reference Frame Origin	The point on the sensor from which all forces and torques are measured.
Sensor	The component that converts a detected load into electrical signals.
Sensor System (or configuration)	The entire assembly consisting of a sensor body and a system interface to translate force and torque signals into a specific communication interface/protocol.
Tool Interface Plate	An interface plate that attaches the customer's tooling to the tooling side (sensing side) of the sensor.
Torque	The application of a force through a lever or moment arm that causes something to want to turn. For example, a user applies torque to a screw to make it turn. Torque = force x moment arm length.
T_{xy}	The resultant torque vector comprised of components T_x and T_y .

1. Safety

The safety section describes general safety guidelines to be followed with this product, explanations of the notifications found in this manual, and safety precautions that apply to the product. Product specific notifications are imbedded within the sections of this manual (where they apply).

1.1 Explanation of Notifications

These notifications are used in all of ATI manuals and are not specific to this product. The user should heed all notifications from the robot manufacturer and/or the manufacturers of other components used in the installation.



DANGER: Notification of information or instructions that if not followed will result in death or serious injury. The notification provides information about the nature of the hazardous situation, the consequences of not avoiding the hazard, and the method for avoiding the situation.



WARNING: Notification of information or instructions that if not followed could result in death or serious injury. The notification provides information about the nature of the hazardous situation, the consequences of not avoiding the hazard, and the method for avoiding the situation.



CAUTION: Notification of information or instructions that if not followed could result in moderate injury or will cause damage to equipment. The notification provides information about the nature of the hazardous situation, the consequences of not avoiding the hazard, and the method for avoiding the situation.

NOTICE: Notification of specific information or instructions about maintaining, operating, installing, or setting up the product that if not followed could result in damage to equipment. The notification can emphasize, but is not limited to: specific grease types, best operating practices, and maintenance tips.

1.2 General Safety Guidelines

The customer should verify that the sensor is rated for the maximum load and torque expected during operation. Because static forces are less than the dynamic forces from the acceleration or deceleration of the robot, be aware of the dynamic loads caused by the robot.

1.3 Safety Precautions



CAUTION: Modifying or disassembly of the sensor could cause damage and void the warranty. Use the supplied mounting interface plate and the provided tool side mounting bolt pattern to mount the sensor to the robot and customer tooling to the sensor. For more information, refer to the customer drawings.



CAUTION: Probing openings in the sensor causes damage to the instrumentation. Avoid prying into the openings of the sensor.



CAUTION: Do not overload the sensor. Exceeding the single-axis overload values of the sensor causes irreparable damage.



CAUTION: The sensor should be protected from impact and shock loads that exceed rated ranges during transportation as the impacts can damage the sensor's performance. Refer to [Section 7—Specifications](#) for more information about rated ranges.

2. Product Overview

The Axia90 Force/Torque (F/T) sensor detects six components of force and torque ($F_x \setminus F_y \setminus F_z \setminus T_x \setminus T_y \setminus T_z$) that are applied to the tool side of the sensor. The sensor communicates this data to a device (such as a personal computer, robot, or PLC). The ATI Axia-series product line differs from the other (non-Axia) ATI F/T sensor models. Thus, the Axia sensors have different options and available features. The Axia-series force/torque sensors are available in several different payload and communication interface versions. For more information about the communication interface, refer to the applicable ATI Axia sensor manual in [Table 2.1](#).

The sensor's mounting side attaches to a rigid fixture or robot. The robot mounting side of the sensor has a 81.065 mm diameter bolt circle (BC) for (6) M4 socket head cap screws and (2) 3 mm slip-fit dowel pin holes. The tool side attaches to the customer tooling. The tool side has a 50 mm BC pattern with (7) M6 tapped holes, 6 mm slip-fit dowel pin hole, and a 31.5 mm recess. For more information on the mounting patterns, refer to the [ATI Axia90 sensor customer drawing](#). If the sensor does not have the same bolt pattern as the mounting or tool sides, use interface plates; refer to [Section 3.1—Interface Plates](#). The sensor is IP67 rated.

An M8 8-pin male connector is for power and communication. On the side of the sensor, LEDs indicate the sensor's operational state. For the connector pin assignments on the sensor and cables and more information about the LEDs, refer to the applicable ATI communication interface manual in [Table 2.1](#).

The ATI Axia90 sensor customer drawing is available on the ATI website: https://www.ati-ia.com/app_content/Documents/9630-05-0007.auto.pdf.

Figure 2.1—Axia90 F/T Sensor

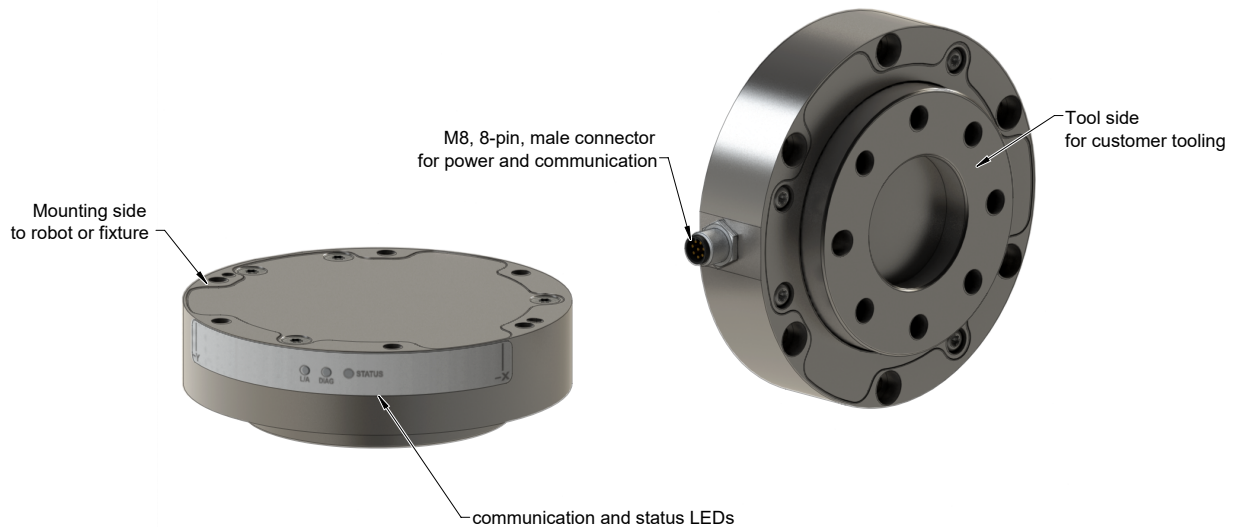

For more information on the electrical and software features of a specific communication interface version and the applicable cable, refer to the ATI manual in the following table:

Table 2.1—ATI Communication/Software Manual Reference			
Sensor Model ATI P/N	Communication Type	ATI Cable P/N	Refer to the ATI Manual
9105-NET- Axia90-M50	Ethernet	9105-C-ZC27-ZC28-4 ¹ 9105-C-ZC28-U-RJ45S-x	ATI F/T Ethernet Axia manual (ATI document # 9620-05-C-Ethernet Axia)
9105-ECAT- Axia90-M50	EtherCAT	9105-C-ZC27-ZC28-4 ¹ 9105-C-ZC28-U-RJ45S-x	ATI F/T EtherCAT Axia manual (ATI document # 9620-05-C-EtherCAT Axia)
9105-RS422- Axia90-M50	RS422	9105-C-ZC27-ZC28-4 ¹ 9105-C-ZC28-MS-ZC35-4 ²	ATI F/T RS422 Axia manual (ATI document # 9620-05-C-RS422 Axia)
Note: 1. Included in 9105-CKIT-ZC27-ZC28-X refer to Table 3.2 . 2. Customers must use either the 9105-C-ZC28-MS-ZC35-X DB9 serial cable or their own RS422 serial cable with a DB9 or USB connector to the ATI sensor cable. 3. This ATI manual references the Axia80 sensor, but the software interface concepts still apply to the Axia90 sensor.			

3. Installation



WARNING: Performing maintenance or repair on the sensor when circuits (for example: power, water, and air) are energized could result in death or serious injury. Discharge and verify all energized circuits are de-energized in accordance with the customer's safety practices and policies.



CAUTION: Using fasteners that exceed the customer interface depth penetrates the body of the sensor, damages the electronics, and voids the warranty. For more information, refer to the customer drawings.



CAUTION: Thread locker applied to fasteners must not be used more than once. Fasteners might become loose and cause equipment damage. Always apply new thread locker when reusing fasteners.



CAUTION: Avoid damage to the sensor from electrostatic discharge. Ensure proper grounding procedures are followed when handling the sensor or cables connected to the sensor. Failure to follow proper grounding procedures could damage the sensor.



CAUTION: Do not apply excessive force to the sensor and cable connector during installation, or damage will occur to the connectors. Align the keyway on the sensor and cable connector during installation to avoid applying excessive force to the connectors.



Keyway on the
sensor connector.

Keyway on the
cable connector.

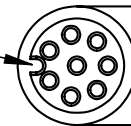

3.1 Interface Plates

The sensor's mounting side attaches to a surface like the robot arm, and the sensor's tool side attaches to the customer tooling. The pattern on the Axia90 tool side is compatible with ISO 9409-1-50-4-M6 bolt pattern. Therefore, if customer tooling mounts to the sensor's tool side with a 50 mm bolt circle and (4) or (7) M6 bolts, an interface plate on the tool side of the sensor is not required. ATI can supply robot mounting kits that include a mounting interface plate and fasteners; for more information, contact ATI (refer to [page B-2](#)). If the customer chooses to supply their own interface plates, refer to the following design guidelines and the [ATI Axia sensor customer drawing](#).



CAUTION: Incorrect installation of interface plates can prevent the F/T sensor from functioning properly.

If the customer chooses to design and build an interface plate, consider the following points:

- The interface plate should include bolt holes for mounting fasteners as well as a dowel pin and boss for accurate positioning to the robot.
- The thickness of the interface plate must provide sufficient thread engagement for the mounting fasteners.
- The mounting fasteners should not interfere with the internal electronics of the sensor. For thread depth, mounting patterns, and other details, refer to the [ATI Axia sensor customer drawing](#).
- Do not use dowel pins that exceed length requirements and prevent interface plate from mating flush with the robot. Fasteners that exceed length requirements create a gap between the interfacing surfaces and cause damage.
- The interface plate must be as strong or stronger than the sensor so that maximum force and torque values applied to the sensor do not distort the interface plate. For these force and torque values, refer to [Section 7—Specifications](#).
- The interface plate must provide a flat and parallel mounting surface for the sensor.

Figure 3.1 —Interface Plate(s)

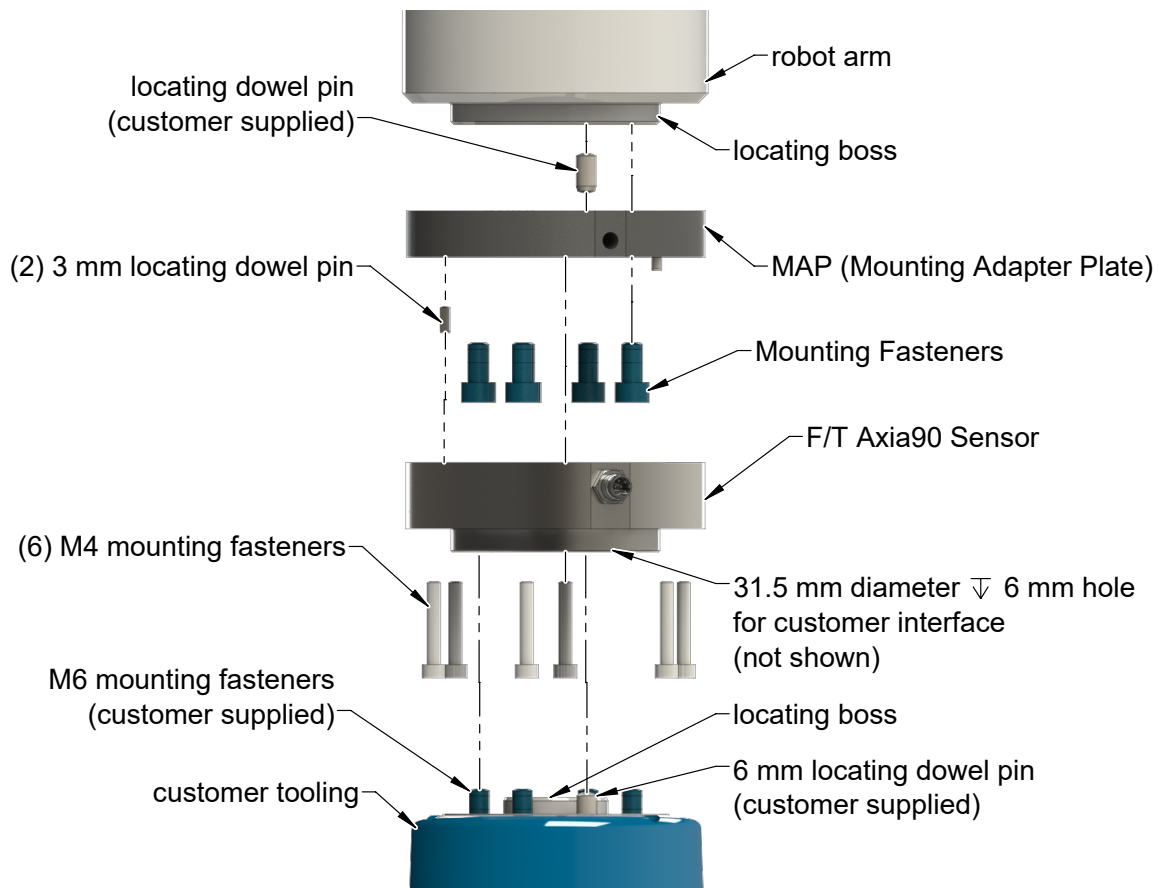

3.2 Routing the Cable

The routing and bending radius of the cable depends upon the customer application. Unlike motionless applications, where the cable is in a static condition, dynamic applications subject the cable to a repetitive motion. For dynamic applications, restrain the cable at a distance that does not expose and damage the sensor's cable connection from the robot's repetitive motion.

Figure 3.2—Routing of the Sensor Cable

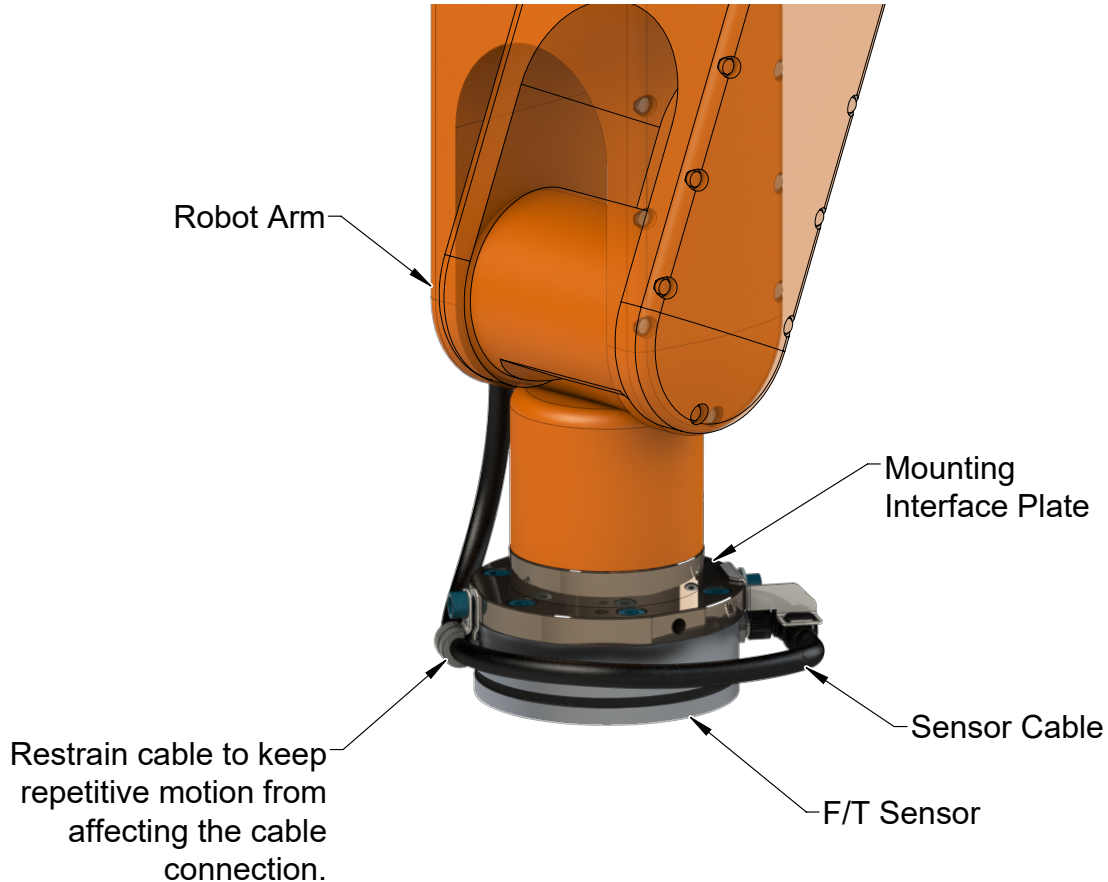

CAUTION: Subjecting the connector to the repetitive motion will cause damage to the connector. Restrain the cable close to the connector so that the repetitive motion of the robot does not interfere with the cable connector.



CAUTION: Improper cable routing may cause injury to personnel, poor functionality of critical electrical lines, or damage to the equipment. The electrical line, especially where attached to the sensor's connector, must be routed to avoid stress failure, sharp bends, or a disconnection from the equipment. Damage to the sensor or cable from improper routing will void the warranty.

For added stability, zip ties can be used to secure the cable to a mounting bracket (refer to the following figure). The zip ties should never contact the cable jacket.

Figure 3.3—Use Zip Ties on the Connector (sensor shown for reference only)

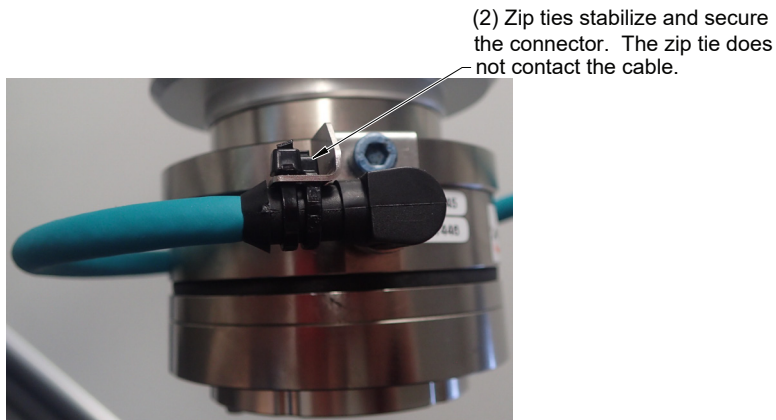

Route the sensor cable so that it is not stressed, pulled, kinked, cut, or otherwise damaged throughout the full range of motion. Use a robot dresspack solution, if possible. Examples of how to route the cable, if a dresspack is not available, are shown in the following figures and descriptions. Affix the cable by using hook and loop straps or Velcro® straps; do not use cable ties or zip ties.

Figure 3.4—Use Hook and Loop or Velcro® Straps on the Cable (sensor shown for reference only)

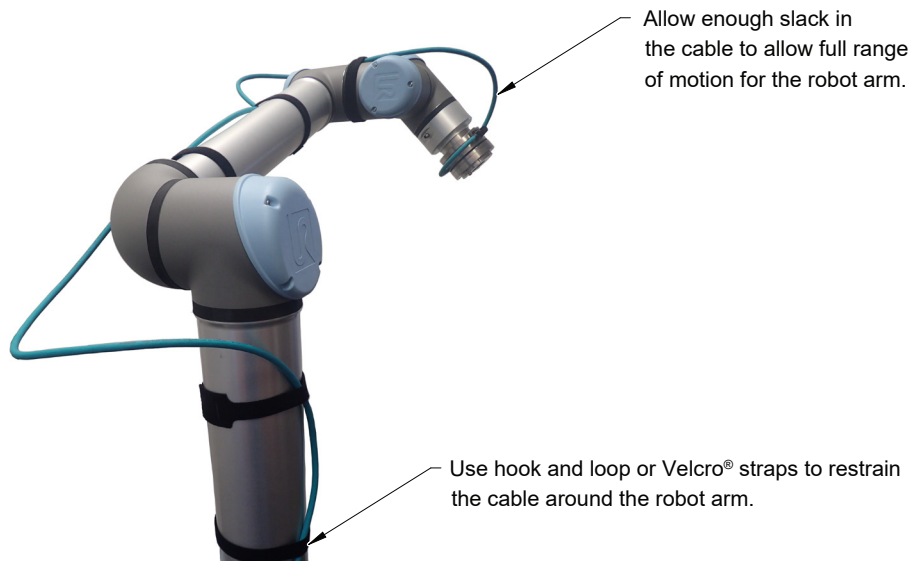

CAUTION: Do not use cable ties or zip ties to bundle cables or restrain the cable to the robot arm. Directly affixing cable ties or zip ties to the cable jacket will damage the cable. Use hook and loop or Velcro straps on the cable jacket surfaces. Examples of the incorrect and correct methods to restrain or bundle cables are in the following pictures:

INCORRECT

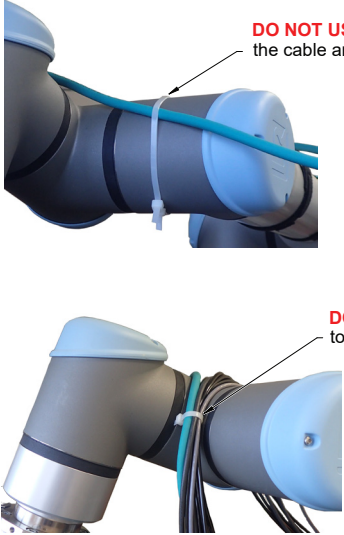

CORRECT

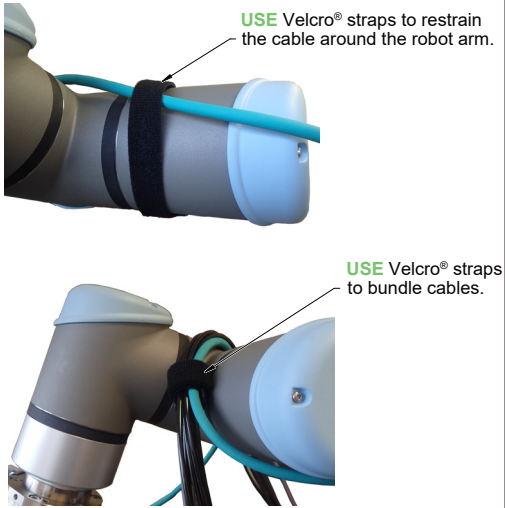

CAUTION: Do not damage or crush the cable by over tightening the straps on the cable.

CAUTION: When routing the cables, do not bend less than the minimum bending radius specified in [Table 3.1](#). A bend radius too small causes the cable to fail from fatigue of the robot’s repetitive motion.

Table 3.1—Sensor Cable Bending Radius and Dynamic Twist Angle

Cable Part Number	Cable Diameter mm (in)	Static Bending Radius (at room temperature)		Dynamic Bending Radius (at room temperature)		Dynamic Cable Twist Angle per Unit Length
		mm	in	mm	in	
9105-C-ZC27-ZC28-X ^{2,3}	6 (0.24)	25	1	50	2	180°/m or 55°/ft
9105-C-ZC28-U-RJ45S-X ²						

Notes:

- Temperature affects cable flexibility. ATI recommends increasing the minimum dynamic bending radius for lower temperatures.
- The X in the part number represents the cable length. For more information, contact ATI.
- Available in an ATI kit; refer to [Table 3.2](#).
- For information specific to the cable part number, refer to the applicable manual in [Table 2.1](#).

3.3 Cable Kits

For images of the sensor support bracket and P-clip, refer to [Figure 3.2](#) and [Figure 3.5](#).

Table 3.2—Cable Kit 9105-CKIT-ZC27-ZC28-X		
Part Number	Description	Quantity
9105-C-ZC27-ZC28-4	8-pin M12 connector to 8-pin M12 connector with a 4 m cable	1
9005-05-1078	(1) bracket, (1) M5 x 10 socket head cap screw, (1) M5 flat washer, and (1) tie	1
9005-05-1079	(1) P-clamp and (1) M5 x 10 socket head cap screw	1

3.4 Install the Sensor

Parts required: Refer to [Figure 3.5](#) and [ATI Axia sensor customer drawing](#)

Tools required: 3 mm and 4 mm hex key

Supplies required: Clean cloth, Loctite® 242

1. Clean the mounting surfaces.
2. Use the mounting fasteners to attach the interface plate to the mounting surface.

NOTICE: When installing an interface plate:

- Screws must have a minimum thread engagement length of 4.5 mm. Maximum screw thread engagement shall not exceed the threaded depth listed on the [ATI Axia sensor customer drawing](#).
- Unless otherwise specified, apply Loctite 242 to the (6) M4 socket head cap screws (class 12.9) so that the fasteners secure the sensor to the mounting plate.

3. Attach the mounting side of the sensor to the interface plate.
 - a. Secure the mounting side of the sensor to the interface plate with (6) M4 socket head cap screws (class 12.9). Use a 3 mm hex key to tighten the fasteners 45 in-lbs (5.08 Nm).
4. Once the sensor is installed on the robot, the customer tooling can be installed.

NOTICE: The tool must not touch any other part of the sensor except the tool side; otherwise, the sensor will not properly detect loads.

Figure 3.5—Installation of the Sensor to the Robot

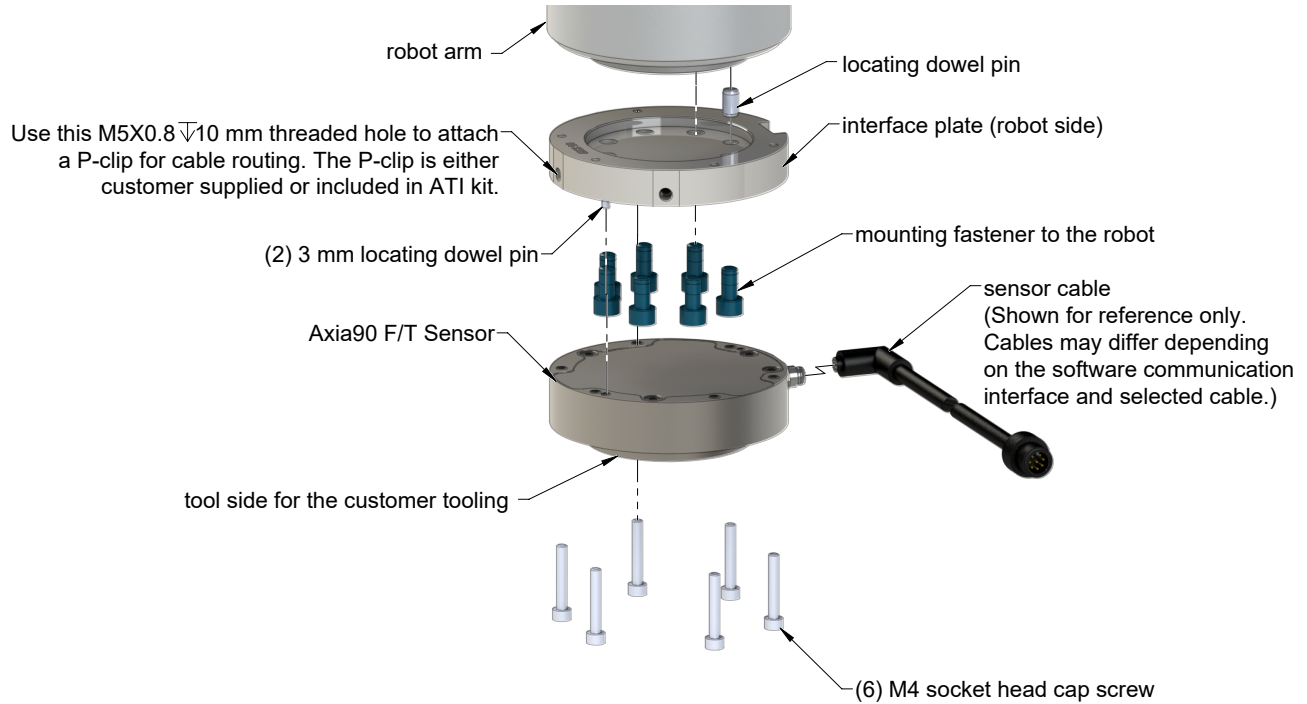

NOTICE: For the LED outputs that indicate the sensor's operational condition, refer to the applicable manual listed in [Table 2.1](#).

5. Connect the cable(s) to the sensor and customer application. For the sensor and cable connector pinout information, refer to the applicable manual in [Table 2.1](#).
6. After connecting the cable to the customer interface, set up the sensor communication interface software; for additional information about the software communication interface, refer to the applicable manual in [Table 2.1](#).
7. Properly restrain and route the cable (refer to [Section 3.2—Routing the Cable](#)). If using an ATI cable kit:
 - a. Above the sensor connector, secure the bracket to the interface plate. Insert the M5 screw through the flat washer. Use a 4 mm hex key to tighten the M5 socket head cap screw.
 - b. Use the tie in the kit to secure the connector to the bracket (refer to [Figure 3.3](#)).
 - c. Secure the P-clip to the interface plate (refer to [Figure 3.2](#)). Use a 4 mm hex key to tighten the M5 socket head cap screw.
 - d. Route the cable (refer to [Section 3.2—Routing the Cable](#)).
8. After installation is complete, the sensor is ready for an accuracy check (refer to [Section 3.6—Accuracy Check Procedure](#)).
9. Safely start normal operation.

3.5 Remove the Sensor

Tools required: 3 mm hex key

1. Turn off all energized circuits, for example: electrical.
2. Remove the cable from the sensor.
3. Supporting the customer tooling, remove the customer supplied screws that attach the customer tooling to the sensor.
4. Supporting the sensor, use a 3 mm hex key to remove the (6) M4 socket head cap screws that secure to the sensor to the mounting interface plate or surface.
5. Remove the sensor

3.6 Accuracy Check Procedure

Complete the following procedures after the initial installation of the sensor to the robot and once annually for maintenance.

NOTICE: The mass on the tool side can be the weight of the tooling used in the application.

1. Attach a fixed mass to the tool side of the F/T sensor:
 - a. Remove cables that form bridges between the sensor's mounting and tool sides.
2. Power on the sensor. Allow a 30 minute warm-up time. Minimize external sources of temperature change.

NOTICE: For optimal results, write a robot program to move the sensor and mass to each of the following positions sequentially. At each position, the robot should pause to record the sensor's output. Avoid jogging the robot and waiting several minutes between each position.

3. Move the robot so that the sensor is in the following positions:
 - a. Record the sensor's output, $F_{x, point n}$, $F_{y, point n}$, $F_{z, point n}$, at each point without biasing.
 - Point 1: +Z up
 - Point 2: +X up
 - Point 3: +Y up
 - Point 4: -X up
 - Point 5: -Y up
 - Point 6: -Z up
4. Calculate $F_{x, average}$, $F_{y, average}$, and $F_{z, average}$:
 - a. Use the following equations, to complete the calculations:

$$F_{x, average} = \frac{F_{x, point 1} + F_{x, point 2} + \dots + F_{x, point 6}}{6}$$

$$F_{y, average} = \frac{F_{y, point 1} + F_{y, point 2} + \dots + F_{y, point 6}}{6}$$

$$F_{z, average} = \frac{F_{z, point 1} + F_{z, point 2} + \dots + F_{z, point 6}}{6}$$

5. For each of the 6 points, complete the following calculation:

$$F_x = F_{x, point n} - F_{x, average}$$

$$F_y = F_{y, point n} - F_{y, average}$$

$$F_z = F_{z, point n} - F_{z, average}$$

$$\text{Tooling Mass} = \sqrt{F_x^2 + F_y^2 + F_z^2}$$

6. The calculated tooling masses for all (6) points should deviate from each other by less than twice the worst accuracy rating of the sensor.
 - For example: the Axia90-M50 sensor's rated accuracy is 2% the range on all axes. For a 1000 N F_{xy} range and a 2000 N F_z range, the allowable errors of any single data point would be ± 20 N F_{xy} and ± 40 N F_z respectively. Since F_z has the larger tolerance, then one data point could be + 40 N and another data point could be - 40 N, for a total range (max-min) of 80 N error.
 - In addition, the tooling mass should be within 80 N of the results of this test when it was performed with a new sensor.
7. If this test fails, then the sensor should be returned to ATI for diagnosis or recalibration.

3.7 Detecting Sensitivity Changes

Sensitivity checking of the sensor can also be used to measure the Axia sensor's health. Apply known loads to the sensor and verifying the system output matches the known loads. For example, a sensor mounted to a robot arm may have an end-effector attached to it. Use the following process to set a sensitivity value:

1. If the end-effector has moving parts, they must be moved in a known position.
 - a. Place the robot arm in an orientation that allows the gravity load from the end-effector to exert load on many sensor output axes.
2. Record the output readings.
3. Position the robot arm to apply another load, this time causing the outputs to move far from the earlier readings.
4. Record the second set of output readings.
5. Find the differences from the first and second set of readings.
6. Use the differences as a sensitivity value.

Even if the sensitivity values vary from sample set to sample set, these values can be used to detect gross errors. Either the resolved outputs or the raw sensor voltages may be used (the same must be used for all steps of this process).

4. Operation

Information that applies generally to all Axia90 sensors is in the following section. For more information specific to the communication protocol of the sensor, such as sampling rate, LEDs, operation commands, refer to the applicable manual in [Table 2.1](#).

4.1 Sensor Environment



CAUTION: Damage to the outer jacketing of the sensor cable could enable moisture or water to enter an otherwise sealed sensor. Ensure the cable jacketing has not deteriorated to prevent sensor damage.

NOTICE: Sensors may react to exceptionally strong and changing electromagnetic fields, such as those fields created by magnetic resonance imaging (MRI) machines.

The user must ensure that the water in the environment does not exceed the IP67 rating of the sensor. With an IP67 rating, the sensor is dustproof and water resistant up to 1 m of submersion in fresh water for up to 30 minutes as well as when exposed to high pressure spray. While the Axia90 sensor is IP67 rated, keep debris and dust from accumulating on or in the sensor.

4.2 Tool Transformation

By default, the forces and torques are reported with respect to a point of origin on the sensor that is set by ATI. For the sensor's point of origin, refer to the [ATI Axia sensor customer drawing](#). The tool transformation function allows measurement of the forces and torques at a reference point other than the sensor's point of origin.



CAUTION: If the customer sets a reference point that is at the same location to which a force is applied, there will be no report of a torque applied to the sensor. As a result, the sensor could be overloaded (refer to [Section 4.2.1—Avoid Overloading the Sensor During Tool Transformation](#)). Therefore, when evaluating overloading conditions, use the sensor's point of origin as the reference point.

The user defines a reference point by inputting a parameter set that is a series of (3) displacements ($D_x \setminus D_y \setminus D_z$) and (3) rotations ($R_x \setminus R_y \setminus R_z$), for example:

$D_x = -97.3 \text{ mm}$ $D_y = 46.1 \text{ mm}$ $D_z = 201.82 \text{ mm}$ $R_x = +90^\circ \text{ rotation}$ $R_y = +180^\circ \text{ rotation}$ $R_z = 0^\circ \text{ rotation}$

If zeros are entered for any of the parameter set values, the tool transformation is not performed for that particular parameter. Entering zero for all of the parameters, turns the tool transformation feature off. Once a new parameter set is entered and saved, previously entered parameter sets are no longer in effect.

Once a user enters a parameter set, the displacements are performed first. The displacements of the user reference frame of origin from the sensor point of origin is shown in the following figure. In this figure, the user reference frame of origin has not yet rotated relative to the sensor point of origin.

NOTICE: In the following figures, the sensor model is shown for reference only. The connector and sensor axes may align differently between sensor models. To determine the location of the default sensor axes, refer to the ATI sensor drawing or the axes labels on the sensor.

**Figure 4.1—Tool Transformation : Distances
 (sensor shown for reference only)**

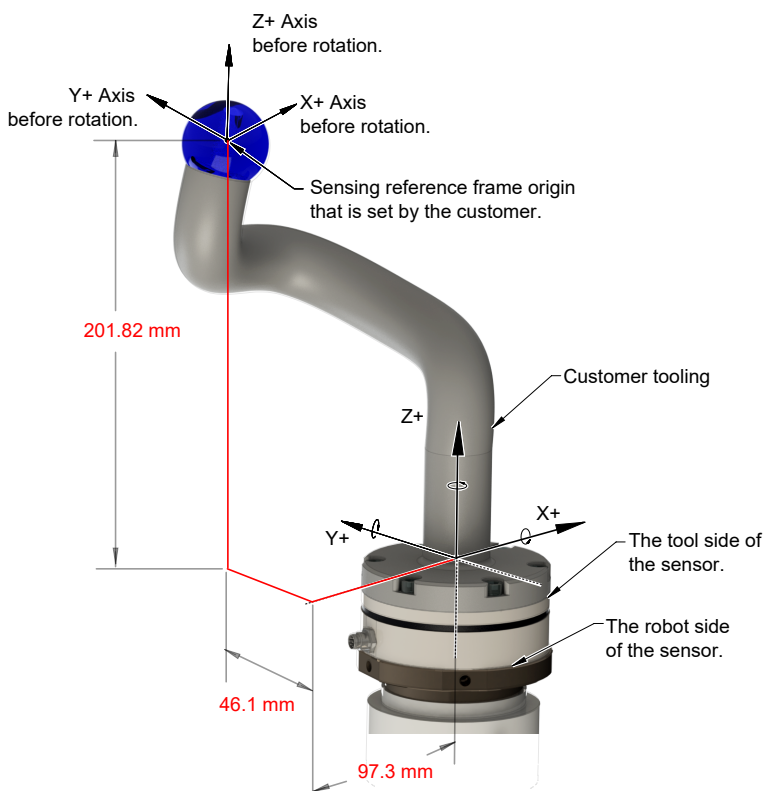

After the displacements, the user point of origin rotates in the following order:

1. The first rotation is about the X-axis.
 - Recall in this example $R_x = +90^\circ$ rotation. The user point of origin rotates $+90^\circ$ about the X-axis, in the following figure.

**Figure 4.2—Tool Transformation : Rotation About the X-Axis
(sensor shown for reference only)**

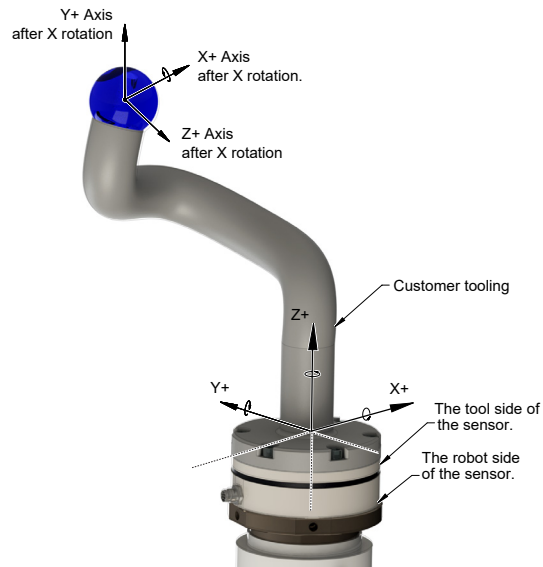

2. The second rotation is about the Y-axis of the new user output reference frame.
 - In this example $R_y = +180^\circ$ rotation. The user point of origin rotates $+180^\circ$ about the Y-axis of the new user output reference frame, in the following figure.

**Figure 4.3—Tool Transformation: Rotation About the Y-Axis
(sensor shown for reference only)**

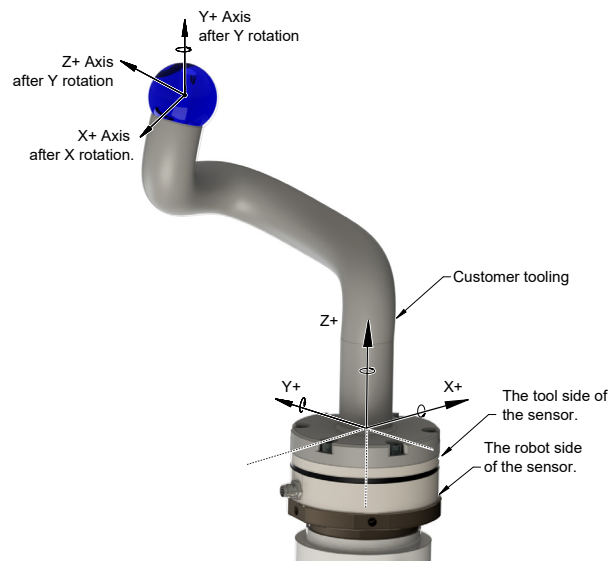

3. The third and final rotation is about the Z-axis of the new user output reference frame.
 - In this example $R_z = 0^\circ$ rotation. Therefore, the user point of origin does not rotate any more.
- After, the rotations are complete, the final user reference frame of origin is set.

4.2.1 Avoid Overloading the Sensor During Tool Transformation

It is possible for the user to set a reference point of origin that does not detect that a torque is applied to the customer tooling, and by extension, the sensor. Torque is the force multiplied by the distance of that force from a reference point of origin. If the customer reference point of origin is at the same point at which a force is applied, the distance from that force to the customer reference point of origin is zero. Any force that is multiplied by a distance of zero yields zero torque. The software tool transformation reports that no torque is applied to the sensor. However, the sensor's point of origin has not changed, and the force is still applied at a distance from the sensor's point of origin. Therefore, if the customer is evaluating overloading conditions, the customer should use the sensor's point of origin as the reference point.

4.2.2 Tool Transformation Functionality Through a Communication Interface

The user defines a reference point by inputting a parameter set that is a series of (3) displacements ($D_x \setminus D_y \setminus D_z$) and (3) rotations ($R_x \setminus R_y \setminus R_z$). For commands that write a parameter set and units, refer to the appropriate manual in [Table 2.1](#).

5. Maintenance

5.1 Periodic Inspection

With industrial-type applications that frequently move the system's cabling, inspect the cable jacket for signs of wear. While the Axia sensor is IP67 rated, keep debris and dust from accumulating on or in the sensor. Clean the surface of the sensor with isopropyl alcohol.

5.2 Periodic Calibrating

Periodic calibration of the sensor and its electronics is required to maintain traceability to national standards. The sensor cannot be calibrated in the field; return the sensor to ATI for recalibration. Contact an ATI account manager or rma-admin@ati-ia.com to request a Returned Materials Authorization (RMA) for recalibration. ATI recommends annual accuracy checks (refer to [Section 3.6—Accuracy Check Procedure](#)). If the sensor does not meet the performance requirements of the user application and fails the accuracy check, return the sensor to ATI for recalibration.

6. Troubleshooting

This section includes solutions to some issues that might arise when setting-up and using the sensor. For questions and troubleshooting assistance with software, refer to the appropriate manual in [Table 2.1](#). Answers to frequently asked questions are available from the ATI website: https://www.ati-ia.com/library/documents/FT_FAQ.pdf.

The information in this section should answer many questions that might arise in the field. Customer service is available to users who have questions or concerns addressed in the manuals.

Note

Please read the manual before calling customer service. Before calling, have the following information available:

1. Serial number (e.g., FT01234)
2. Sensor model (e.g., Axia90-M50)
3. Calibration (e.g., US-15-50, SI-65-6, etc.)
4. Accurate and complete description of the question or problem
5. Computer and software information (operating system, PC type, drivers, application software, and other relevant information about the application's configuration)

If possible, be near the F/T system when calling.

For additional troubleshooting information or to speak with a customer service representative, please contact ATI at:

ATI Industrial Automation

1031 Goodworth Drive
Apex, NC 27539 USA
www.ati-ia.com

Application Engineering

Tel: +1.919.772.0115, Extension 511
Fax: +1.919.772.8259
E-mail: ft.support@novanta.com
24/7 Support: +1 855 ATI-IA 00 (+1 855-284-4200)

6.1 Basic Guidance for Troubleshooting

Basic symptoms of inaccurate data and errors are listed in the following section. For each symptom, causes and appropriate solutions are suggested.

Symptom: Noise — jumps in force torque readings greater than 0.05% of full-scale counts.

Cause: Noise can be caused by mechanical vibrations and electrical disturbances that are possibly from a poor ground. Electrical interference can also come from a high noise output device such as a motor.

Solution: Make sure that the DC supply voltage for the Axia sensor has little to no noise superimposed. Ground the sensor by connecting the cable's shield to ground. In most setups, 0 V is also connected to ground. Connect the robot or other fixture to the same ground.

Verify that sensor cables do not cross over other cables or are within close proximity to other equipment that could generate electrical noise.

Avoid sources of mechanical noise. If not possible, apply a filter to the data as described in the applicable communication interface ATI manual in [Table 2.1](#).

Cause: Noise can also indicate component failure within the system.

Solution: Check the status code of the sensor; refer to the applicable communication interface ATI manual in [Table 2.1](#).

Perform an accuracy check; refer to [Section 3.6—Accuracy Check Procedure](#) or refer to [Section 4.5: How do I evaluate the accuracy of health of the sensor?](#) in the Frequently Asked Questions (FAQ) ATI document located at: https://www.ati-ia.com/library/documents/FT_FAQ.pdf.

To return the sensor to ATI for inspection, contact ATI for a Returned Materials Authorization (RMA); refer to [Section 5.2—Periodic Calibrating](#).

Symptom: Drift — when the force torque data continues to increase or decrease after a load is removed.

Cause: Some drift from a change in temperature is normal. Drift is observed more easily in the Z axis, compared to the X and Y axes.

Solution: For approximately thirty minutes, allow the sensor to warm up until it is at a steady state with the air and other objects touching the sensor.

Use the bias command to shift the readings back to zero. Bias regularly.

Use an insulator between the sensor and any tooling or fixtures which are at a different temperature. Avoid creating a temperature gradient across the sensor. Shield the sensor from excessive air flow.

For more information about how to avoid drift from temperature change, refer to the following ATI document: <https://www.ati-ia.com/Library/Documents/DriftExplanation.pdf>.

Symptom: Hysteresis — when the sensor is loaded from a zeroed or biased state and then the load is removed, sensor output does not immediately return to zero.

Cause: Mechanical coupling or internal failure can cause Hysteresis which is outside of the sensor's specified and acceptable measurement uncertainty (error) range.

Solution: Verify the sensor is properly installed, fasteners are tightened, and the customer tooling is securely installed per [Section 3—Installation](#).

Use the bias command to shift the readings back to zero.

Symptom: The initial F/T values are non-zero and no load is applied.

Normal. Bias the sensor to bring all the F/T values back to zero.

Symptom: The sensor does not report accurate F/T data.

Cause: The sensor may be in an error state.

Solution: Check the sensor status code. For how to read and interpret the status code, refer to the appropriate manual in [Table 2.1](#)). If there are no error bits ON, continue troubleshooting.

Cause: The sensor is not properly installed or not mounted to a flat, stiff surface.

Solution: Verify the sensor is correctly installed per [Section 3—Installation](#).

Cause: The mounting fasteners are not properly secured.

Solution: Verify the fasteners are secured per the installation procedures in [Section 3.4—Install the Sensor](#).

If fasteners are customer supplied, do not use fasteners that are too long. For maximum fastener penetration depth into the sensor, refer to the [ATI sensor drawing](#). When selecting fasteners: use a high quality, high strength screw or bolt and ensure the fastener's material type, fastener head, and fastener grade are proper for the application.

Cause: Mechanical coupling — an external object such as customer tooling or utilities contacts a sensor's surface between the mounting side and tool side.

Solution: Remove any debris between the tool side and interface plate. Use proper cable management for cables and hoses; do not connect them tightly between the mounting and tool side of the sensor.

Anything that contacts surfaces such as the through hole in the sensor or cover plates on either side of the sensor induces loading or movement that could result in inaccurate F/T data.

Symptom: The F/T values do not match expected values, for example: the F/T values are fluctuating but are higher than a known applied load.

Cause: The sensor may be in a mode that reports gage data instead of F/T data.

Solution: Gage data is not a 1:1 correlation to F/T axis data. View F/T data instead of gage data; refer to the applicable communication interface ATI manual in [Table 2.1](#).

Cause: The sensor outputs data in counts. The user must convert the counts to calibration units.

Solution: Counts must be divided by the Counts per Force (CpF) or Counts per Torque (CpT) in order to convert them to calibration units such as N and Nm.

In addition to CpF and CpT, depending on the communication protocol, the values may be further scaled by a 16-bit scale factor. 16-bit counts must be divided by (CpF or CpT ÷ 16-bit scale factor) in order to convert to calibration units.

Cause: If once the F/T readings are converted to calibration units and exceed the sensor's calibration range per [Section 7.3—Calibration Range](#), the reported values are inaccurate and the sensor may be overloaded.

Solution: Check the status code. For information on how to read and interpret the sensor's status code, refer to the applicable communication interface ATI manual in [Table 2.1](#).

Unmount the sensor. Improper mounting methods can induce high loads in the sensor.

After reinstalling the sensor and without applying a load, if errors such as "Sensing Range Exceeded", "Gage Out of Range", or "Gage Broken" persist, the sensor is likely permanently damaged due to overload.

7. Specifications

Some requirements and specifications for the Axia90 sensor are covered in the following sections. For more information, refer to the customer drawing.

7.1 Environmental Conditions

Table 6.1—Environmental Conditions	
Parameter	Value
Storage Temperature, °C	-20 to +85
Operating Temperature, °C	0 to +65
Relative Humidity	<95%, non-condensing

7.2 Electrical Specifications

Table 6.2—Power Supply ¹				
Power Source	Voltage			Power Consumption
	Minimum	Nominal	Maximum	Maximum
DC Power	12 V	24 V	30 V	1.5 W

Notes:

- The power supply input is reverse polarity protected. If the power and ground to the power supply inputs are plugged in reverse, then the reverse polarity protection stops the incorrectly wired supply input from damaging or powering on the sensor.

7.3 Calibration Range

Table 6.3—Calibration Range			
Model	Axia90-M50		
Parameter	Fxy	Fz	Txyz
Calibration Range 0 (SI-1000-50)	1000 N	2000 N	50 Nm

7.4 Default Peak Values

When powered on, the sensor records the peak values seen on any single axis. The following values are the default values programmed at the factory during calibration. If the sensor shows peak values higher than these defaults, the sensor has been loaded past the intended calibrated sensing range.

Table 6.4—Default Peak Values in Counts						
Sensor Model	Axia90-M50					
Parameter	Fx	Fy	Fz	Tx	Ty	Tz
Positive Default Value	6.24999 x 10 ⁸		1.249998 x 10 ⁹			3.124995 x 10 ⁷
Negative Default Value	-6.24999 x 10 ⁸		-1.249998 x 10 ⁹			-3.124995 x 10 ⁷

8. Terms and Conditions of Sale

The following Terms and Conditions are a supplement to and include a portion of ATI's Standard Terms and Conditions, which are on file at ATI and available upon request.

ATI warrants to Purchaser that force torque sensor products purchased hereunder will be free from defects in material and workmanship under normal use for a period of one (1) year from the date of shipment. The warranty period for repairs made under a RMA shall be for the duration of the original warranty, or ninety (90) days from the date of repaired product shipment, whichever is longer. ATI will have no liability under this warranty unless: (a) ATI is given written notice of the claimed defect and a description thereof with thirty (30) days after Purchaser discovers the defect and in any event, not later than the last day of the warranty period and (b) the defective item is received by ATI not later than (10) days after the last day of the warranty period. ATI's entire liability and Purchaser's sole remedy under this warranty is limited to repair or replacement, at ATI's election, of the defective part or item or, at ATI's election, refund of the price paid for the item. The foregoing warranty does not apply to any defect or failure resulting from improper installation, operation, maintenance, or repair by anyone other than ATI.

ATI will in no event be liable for incidental, consequential, or special damages of any kind, even if ATI has been advised of the possibility of such damages. ATI's aggregate liability will in no event exceed the amount paid by the purchaser for the item which is the subject of claim or dispute. ATI will have no liability of any kind for failure of any equipment or other items not supplied by ATI.

No action against ATI, regardless of form, arising out of or in any way connected with products or services supplied hereunder, may be brought more than one year after the cause of action accrued.

No representation or agreement varying or extending the warranty and limitation of remedy provisions contained herein is authorized by ATI, and may not be relied upon as having been authorized by ATI, unless in writing and signed by an executive officer of ATI.

Unless otherwise agreed in writing by ATI, all designs, drawings, data, inventions, software, and other technology made or developed by ATI in the course of providing products and services hereunder, and all rights therein under any patent, copyright, or other law protecting intellectual property, shall be and remain ATI's property. The sale of products or services hereunder does not convey any expressed or implied license under any patent, copyright, or other intellectual property right owned or controlled by ATI, whether relating to the products sold or any other matter, except for the license expressly granted below.

In the course of supplying products and services hereunder, ATI may provide or disclose to Purchaser confidential and proprietary information of ATI relating to the design, operation, or other aspects of ATI's products. As between ATI and Purchaser, ownership of such information, including without limitation any computer software provided to Purchaser by ATI, shall remain in ATI and such information is licensed to Purchaser only for Purchaser's use in operating the products supplied by ATI hereunder in Purchaser's internal business operations.

Without ATI's prior written permission, Purchaser will not use such information for any other purpose or provide or otherwise make such information available to any third party. Purchaser agrees to take all reasonable precautions to prevent any unauthorized use or disclosure of such information.

Purchaser will not be liable hereunder with respect to disclosure or use of information which: (a) is in the public domain when received from ATI, (b) is thereafter published or otherwise enters the public domain through no fault of Purchaser, (c) is in Purchaser's possession prior to receipt from ATI, (d) is lawfully obtained by Purchaser from a third party entitled to disclose it, or (f) is required to be disclosed by judicial order or other governmental authority, provided that, with respect to such to maintain the confidentiality of such information.



RS422 Axia Manual

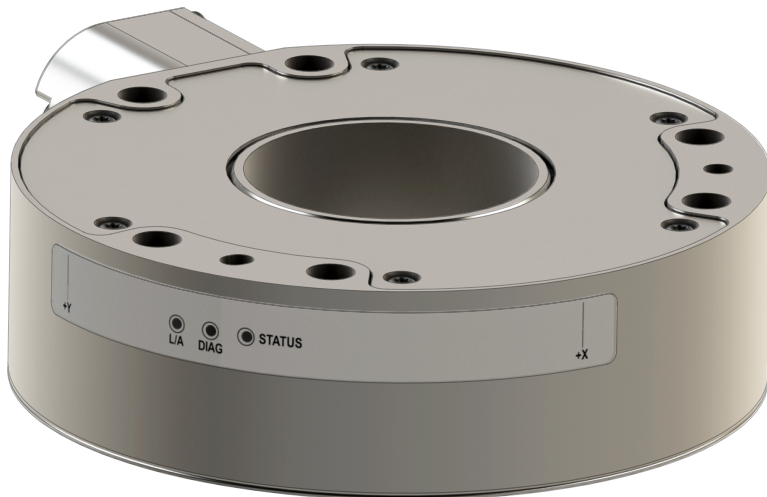

Document #: 9620-05-C-RS422 Axia

Engineered Products for Robotic Productivity

Pinnacle Park • 1031 Goodworth Drive • Apex, NC 27539 • Tel:+1 919.772.0115 • Fax:+1 919.772.8259 • www.ati-ia.com

Foreword

Information contained in this document is the property of ATI Industrial Automation, Inc. and shall not be reproduced in whole or in part without prior written approval of ATI Industrial Automation, Inc. The information herein is subject to change without notice and should not be construed as a commitment on the part of ATI Industrial Automation, Inc. This manual is periodically revised to reflect and incorporate changes made to the F/T system.

ATI Industrial Automation, Inc. assumes no responsibility for any errors or omissions in this document.

Copyright © (2022) by ATI Industrial Automation, Inc., Apex, North Carolina USA. All Rights Reserved.
Published in the USA.

ATI F/T Sensing Systems are considered components/ semi-finished goods intended for use in larger system/
device/ finished good.

In consideration that ATI Industrial Automation, Inc. (ATI) products are intended for use with robotic and/or automated machines, ATI does not recommend the use of its products for applications wherein failure or malfunction of a ATI component or system threatens life or makes injury probable. Anyone who uses or incorporates ATI components within any potentially life threatening system must obtain ATI's prior consent based upon assurance to ATI that a malfunction of ATI's component does not pose direct or indirect threat of injury or death, and (even if such consent is given) shall indemnify ATI from any claim, loss, liability, and related expenses arising from any injury or death resulting from use of ATI components.

All trademarks belong to their respective owners. Windows® is a registered trademark of Microsoft Corporation.

Note:

Please read the manual before calling customer service, and have the following information available:

1. Serial number (e.g., FT01234)
2. Sensor model (e.g., Axia90-M50)
3. Calibration (e.g., US-15-50, SI-65-6, etc.)
4. Accurate and complete description of the question or problem
 - For the status code; refer to [Section 4.6—Status Code](#).
 - For the system's response to the status command; refer to [Section 5.12—Status Command: "status"](#).
5. Computer and software information (operating system, PC type, drivers, application software, and other relevant information about the application's configuration)

Be near the F/T system when calling (if possible).

Please contact an ATI representative for assistance, if needed:

Sale, Service and Information about ATI products:

ATI Industrial Automation

1031 Goodworth Drive
Apex, NC 27539 USA
www.ati-ia.com

Tel: +1.919.772.0115
Fax: +1.919.772.8259

Application Engineering

Tel: +1.919.772.0115, Extension 511
Fax: +1.919.772.8259
E-mail: ft_support@ati-ia.com

24/7 Support: +1 855 ATI-IA 00 (+1 855-284-4200)

Table of Contents

Foreword	2
Glossary	6
1. Safety	8
1.1 Explanation of Notifications	8
1.2 General Safety Guidelines	8
1.3 Safety Precautions	9
2. Product Overview	10
3. Installation	11
3.1 Installation of the Sensor to the Robot	11
3.2 Pin and Wire Assignments for Connectors	11
3.2.1 Axia F/T Sensor	12
3.2.1.1 Axia80 and Axia90 Pin Assignment for the 8-pin M8 Male Sensor Connector .	12
3.2.1.2 Axia130 Pin Assignment for the 8-pin M12 Male Sensor Connector	12
3.2.2 Axia80 and Axia90 Sensor Cable (P/N 9105-C-ZC27-ZC28)	13
3.2.3 Axia130 Sensor Cable (P/N 9105-C-ZC28-ZC28)	14
3.3 Set-up of the RS422 Communication Interface	15
4. Operation	18
4.1 Clock Sync Functionality	18
4.2 LED Self-Test Sequence	19
4.3 LED Normal Operation	20
4.3.1 Sensor Status LED	20
4.3.2 Diag LED	20
4.3.3 RS422 Link/Activity (L/A) LED	20
4.4 Sample Rate	21
4.4.1 Sample Rate Versus Data Rate	21
4.5 Low-Pass Filter	21
4.6 Status Code	25
4.6.1 Status Code: Force/Torque Out of Range or Sensing Range Exceeded	26
5. RS422 Commands	28
5.1 Help Command: “help”, “h”, or “?”	28
5.2 Reset Sensor Command: “reset”	29
5.3 Query Commands: “S” or “C”	29
5.3.1 Converting Counts Per Force/Torque to FT Values	29
5.3.2 Secondary Commands for the Query “C” or “S” Command	29
5.3.3 Examples of Secondary Commands (Specifiers)	31
5.3.4 How to Interpret the Output from “!” Specifier	32

5.4	Bias Command: “bias”	33
5.4.1	Secondary Bias Commands: “on”, “off”, “[values]”	33
5.5	Peak Command: “peak”	33
5.5.1	Peak Command in Counts: “peak C”	34
5.5.2	Peak Reset Command: “peak reset”	34
5.6	Save All Command: “saveall”	34
5.7	Set Command: “set”	35
5.8	Calibration Commands	39
5.8.1	Calibration Range Command: “ set calib”	39
5.8.2	View Calibration Command: “view”	39
5.8.3	Example of Switching Between Calibration Ranges	40
5.9	Baud Rate Command: “set baud”	41
5.10	Simulated Error Command: “simerr”	42
5.11	Diagnostic Status Command: “diag”	42
5.12	Status Command: “status”	43
6.	RS422 Axia Sensor “Robot Mode”	44
6.1	Enter and Exit “Robot Mode”: “M” command	44
6.2	Print a Single Reading of FT Values: “R” command.....	44
6.3	Print and Stop a Continuous Output or High Speed Streaming of FT Values: “S” and “E” command	45
6.4	Print the Counts Per Force and Counts Per Torque for Each Axis: “P” command	45
6.5	How to Interpret Robot Mode Readings	46
6.6	Other Commands	46
6.6.1	Set 16 or 32-Bit Output Values for Each Axis: “W” command	46
6.6.2	Set the ADC Sample Rate: “A” command	47
6.6.3	Set the IIR Filter Shift Value: “F” command	47
6.6.4	Set the Calibration Value: “C” command	47
6.6.5	View the Current Output Bit or Calibration Value in NVM: “R” command.....	47
6.6.6	Bias Command: “O” command	47
7.	Pseudocode Example	48
7.1	Assumed Functions For Pseudocode	48
7.2	Pseudocode to Read Tool Transform Distance Units.....	48
7.3	Pseudocode to Read Tool Transform Distance Units.....	49

8. Troubleshoot	50
8.1 LED Errors	51
8.2 Basic Guidance for Troubleshooting	52
8.3 Reducing Noise	56
8.3.1 Mechanical Vibration	56
8.3.2 Electrical Interference.....	56
9. Specifications	57
9.1 Electrical Specifications	57
9.2 Cable Specifications	58
9.2.1 P/N 9105-C-ZC27-ZC28.....	58
9.2.2 P/N 9105-C-ZC28-ZC28.....	58
9.2.3 P/N 9105-C-ZC28-MS-ZC35-4.....	58
10. Terms and Conditions of Sale	59

Glossary

Term	Definitions
Active Configuration	The configuration that the system is currently using.
ADC	Analog-to-digital converter.
Bias	Biasing is useful for eliminating the effects of gravity (tool weight) or other acting forces. When the bias function is used, the software collects data for the forces and torques that are currently acting on the sensor and use these readings as a reference for future readings. Future readings will have this reference subtracted from them before they are transmitted. Bias may also be referred to as “zero out” or “tare” the sensor.
Calibration	Defines a specific measurement or sensing range for a given sensor. Calibration is also the act of measuring a transducer’s raw response to loads and creating data used in converting the response to forces and torques.
Complex Loading	Any load that is not purely in one axis. Complex loading may reduce measurement range in a given axis.
Configuration	User-defined settings that include which force and torque units are reported and which calibration is to be used. Also defined as the hardware setup of the sensor system.
Coordinate Frame	See Sensor Reference Frame Origin.
CRC	Cyclic Redundancy Check is an error-detecting code commonly used in digital networks and storage devices to detect accidental changes to raw data. Blocks of data entering these systems get a short check value attached, based on the remainder of a polynomial division of their contents.
Data Rate	How fast data is output over the RS422 interface.
Force	A force is a push or pull action on an object caused by an interaction with another object. Force = mass X acceleration
FS	Full-Scale, refers to the limits of a given calibration or sensing range.
FT or F/T	Force and Torque.
F_{xy}	The resultant force vector comprised of components F_x and F_y .
Hysteresis	A source of measurement error that is caused by the residual effects of previously applied loads.
Interface Plate	A separate plate that attaches the sensor to another surface. Interface plates are often used if the bolt pattern on the sensor doesn’t match the bolt pattern on the robot arm or customer tooling. The interface plate has two bolt patterns, one on either side of the plate. One side is for the sensor. The other side is for the robot arm or customer tooling.
IP64	Ingress protection rating “64” designates protection against dust and splashing of water. An IP64 rating does not guarantee protection when a user submerges a device in water or any type of fluid.
IP67	Ingress protection rating “67” designates protection against dust and submersion under 1 m of fresh water.
Master Device	A customer supplied device such as a personal computer, robot, or programmable logic controller (PLC) that is compatible a specific communication interface.
MCU	Microcontroller unit. A part of the software and electronics of the sensor. The MCU contains a computer processing unit that includes memory.
Measurement Uncertainty	Commonly referred to as “accuracy”, “measurement uncertainty” is the worst-case error between the measured value and the true load. The measurement uncertainty is specified as a percentage of the full-scale measurement range for a given sensor model and calibration size. This value takes into account multiple sources of error. The sensor’s calibration certificate lists the measurement uncertainty percentage. For more information, refer to <i>Section 2.2: Measurement Uncertainty</i> in the Frequently Asked Questions (FAQ) document located at: https://www.ati-ia.com/library/documents/FT_FAQ.pdf .

Term	Definitions
Mechanical Coupling	When an external object such as customer tooling or utilities contacts a sensor's surface between the sensor's mounting side and tool side.
N/A	Not applicable.
NVM	Non-Volatile Memory. Storage of information or device memory that can be retrieved even after the device goes through a power cycle (turned off and then back on).
Overload	The condition where more load is applied to the transducer than it can measure. This will result in saturation.
PCB	Printed circuit board.
P/N	Part Number
Power Cycle	When a user removes and then restores power to a device.
Resolution	The smallest change in load that can be measured. Resolution is usually much smaller than accuracy.
Sample Rate	How fast the ADCs are sampling inside the unit.
Saturation	The condition where the transducer or data acquisition hardware has a load or signal outside of its sensing range.
Sensor	The component that converts a detected load into electrical signals.
Sensor Reference Frame Origin	The point on the sensor from which all forces and torques are measured.
Sensor System (or configuration)	The entire assembly consisting of a sensor body and a system interface to translate force and torque signals into a specific communication interface/protocol.
Status Bit	A unit of computer data sent from the ATI F/T sensor.
Status Word	The status code
STRING n	String of n characters
STRING(8)	A data type representing (8) characters, using (8) bytes.
STRING(20)	A data type representing (20) characters, using (20) bytes.
STRING(30)	A data type representing (30) characters, using (30) bytes.
STRING(40)	A data type representing (40) characters, using (40) bytes.
STRING(100)	A data type representing (100) characters, using (100) bytes.
Torque	The application of a force through a lever or moment arm that causes something to want to turn. For example, a user applies torque to a screw to make it turn. Torque = force x moment arm length
T _{xy}	The resultant torque vector comprised of components T _x and T _y .

1. Safety

The safety section describes general safety guidelines to be followed with this product, explanations of the notifications found in this manual, and safety precautions that apply to the product. Product specific notifications are imbedded within the sections of this manual (where they apply).

1.1 Explanation of Notifications

These notifications are used in all of ATI manuals and are not specific to this product. The user should heed all notifications from the robot manufacturer and/or the manufacturers of other components used in the installation.



DANGER: Notification of information or instructions that if not followed will result in death or serious injury. The notification provides information about the nature of the hazardous situation, the consequences of not avoiding the hazard, and the method for avoiding the situation.



WARNING: Notification of information or instructions that if not followed could result in death or serious injury. The notification provides information about the nature of the hazardous situation, the consequences of not avoiding the hazard, and the method for avoiding the situation.



CAUTION: Notification of information or instructions that if not followed could result in moderate injury or will cause damage to equipment. The notification provides information about the nature of the hazardous situation, the consequences of not avoiding the hazard, and the method for avoiding the situation.

NOTICE: Notification of specific information or instructions about maintaining, operating, installing, or setting up the product that if not followed could result in damage to equipment. The notification can emphasize, but is not limited to: specific grease types, best operating practices, and maintenance tips.

1.2 General Safety Guidelines

The customer should verify that the sensor is rated for the maximum load and torque expected during operation. Because static forces are less than the dynamic forces from the acceleration or deceleration of the robot, be aware of the dynamic loads caused by the robot.

1.3 Safety Precautions



CAUTION: Modifying or disassembly of the sensor could cause damage and void the warranty. Use the supplied mounting interface plate and the provided tool side mounting bolt pattern to mount the sensor to the robot and customer tooling to the sensor. For more information, refer to the ATI customer drawings.



CAUTION: Probing openings in the sensor causes damage to the instrumentation. Avoid prying into the openings of the sensor.



CAUTION: Do not overload the sensor. Exceeding the single-axis overload values of the sensor causes irreparable damage.



CAUTION: The sensor should be protected from impact and shock loads that exceed rated ranges during transportation as the impacts can damage the sensor's performance. For more information about rated ranges, refer to the appropriate sensor manual in [Table 2.1](#).

2. Product Overview

The RS422 Axia Force/Torque (F/T) sensor measures six components of force and torque ($F_x \setminus F_y \setminus F_z \setminus T_x \setminus T_y \setminus T_z$) and communicates this data to a device (such as a personal computer, robot, or PLC) that is compatible with an RS422 serial communication interface. The ATI Axia-series product line differs from the other (non-Axia) ATI F/T sensor models. Thus, the Axia sensors have different options and available features. The Axia-series force/torque sensors are available in several different payload and communication interface versions. This manual covers the following topics for the RS422 Axia interface version:

- Electrical specifications and wire information for cables.
- Initial set-up of a console for RS422 communications.
- Operation (LEDs, filter rates, sampling rates, and Status codes)
- RS422 commands and operations.
- Robot mode commands and operations.
- Troubleshooting guidance that relates to RS422.

For additional sensor information, such as installation on a robot, operation, and general troubleshooting, refer to the appropriate ATI Axia F/T sensor manual listed in the following table:

Table 2.1—ATI Axia F/T Sensor Manual	
ATI Axia Sensor Model	Refer to the ATI Axia F/T Sensor Document Number:
Axia80	ATI F/T Axia80 Sensor Manual (ATI Document # 9620-05-B-Axia80)
Axia90	ATI F/T Axia90 Sensor Manual (ATI Document # 9620-05-B-Axia90)
Axia130	ATI F/T Axia130 Sensor Manual (ATI Document # 9620-05-B-Axia130)

3. Installation

 **WARNING:** Performing maintenance or repair on the sensor when circuits (for example: power, water, and air) are energized could result in death or serious injury. Discharge and verify all energized circuits are de-energized in accordance with the customer’s safety practices and policies.

 **CAUTION:** Avoid damage to the sensor from electrostatic discharge. Ensure proper grounding procedures are followed when handling the sensor or cables connected to the sensor. Failure to follow proper grounding procedures could damage the sensor.

 **CAUTION:** Do not apply excessive force to the sensor and cable connector during installation, or damage will occur to the connectors. Align the keyway on the sensor and cable connector during installation to avoid applying excessive force to the connectors.

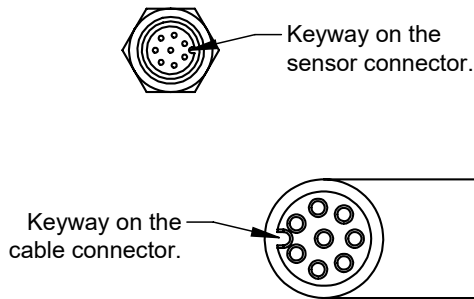

3.1 Installation of the Sensor to the Robot

For instructions on how to install the sensor to the robot, refer to the appropriate sensor manual in [Table 2.1](#).

NOTICE: Unless the sensor is purchased as part of a robot-specific kit, the customer must supply their own RS422 cable from the ATI sensor connector or ATI sensor cable M12 connector to the robot or PC. For example, many RS422 systems use either a DB9 or USB connector. This connector is not provided by ATI.

3.2 Pin and Wire Assignments for Connectors

 **CAUTION:** Ensure the cable shield is properly grounded. Improper shielding on the cables can cause communication errors and an inoperative Axia sensor.

The following section provides the pin assignment for the connector on the Axia sensor and applicable connectors on the cables. For supply voltage ratings, refer to the following table or [Section 9.1—Electrical Specifications](#). For additional cable technical specifications, refer to [Section 9.2—Cable Specifications](#).

Power Source	Voltage			Power Consumption
	Minimum	Nominal	Maximum	Maximum
DC Power	12 V	24 V	30 V	1.5 W

Notes:

1. The power supply input is reverse polarity protected. If the power and ground to the power supply inputs are plugged in reverse, then the reverse polarity protection stops the incorrectly wired supply input from damaging or powering on the sensor.

3.2.1 Axia F/T Sensor

Signals and corresponding pin numbers for the Axia models are listed in the following sections.

3.2.1.1 Axia80 and Axia90 Pin Assignment for the 8-pin M8 Male Sensor Connector

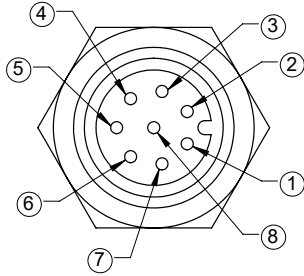
Connector Schematic	Pin Number	Signal
	1	Clock Sync Ground ¹
	2	V +
	3	V - / Ground
	4	Tx -
	5	Rx +
	6	Tx+
	7	Clock Sync ¹
	8	Rx -
	Shell	Shield

Note:

- This connection is optional and is not required for basic functionality. If not using the clock sync functionality, these lines do not need to be connected to anything in the user's system. For more information about the clock sync functionality, refer to [Section 4.1—Clock Sync Functionality](#).

3.2.1.2 Axia130 Pin Assignment for the 8-pin M12 Male Sensor Connector

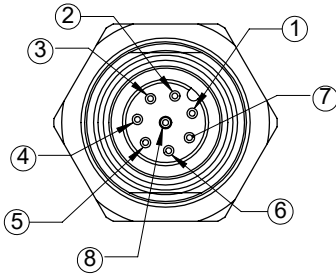
Connector Schematic	Pin Number	Signal
	1	Clock Sync Ground ¹
	2	V +
	3	V - / Ground
	4	Tx -
	5	Rx +
	6	Tx+
	7	Clock Sync ¹
	8	Rx -
	Shell	Shield

Note:

- This connection is optional and is not required for basic functionality. If not using the clock sync functionality, these lines do not need to be connected to anything in the user's system. For more information about the clock sync functionality, refer to [Section 4.1—Clock Sync Functionality](#).

3.2.2 Axia80 and Axia90 Sensor Cable (P/N 9105-C-ZC27-ZC28)

Table 3.4—ZC27 Connector, M8, 8-pin, Female		
Connector Schematic	Pin Number	Signal
	1	Clock Sync Ground ¹
	2	V +
	3	V - / Ground
	4	Tx -
	5	Rx +
	6	Tx +
	7	Clock Sync ¹
	8	Rx -
	Shell	Shield

Note:

1. This connection is optional and is not required for basic functionality. If not using the clock sync functionality, these lines do not need to be connected to anything in the user's system. For more information about the clock sync functionality, refer to [Section 4.1—Clock Sync Functionality](#).

Table 3.5—ZC28 Connector, M12, 8-pin, Male		
Connector Schematic	Pin Number	Signal
	1	Clock Sync Ground ¹
	2	V +
	3	V - / Ground
	4	Tx -
	5	Rx +
	6	Tx +
	7	Clock Sync ¹
	8	Rx -
	Shell	Shield

Note:

1. This connection is optional and is not required for basic functionality. If not using the clock sync functionality, these lines do not need to be connected to anything in the user's system. For more information about the clock sync functionality, refer to [Section 4.1—Clock Sync Functionality](#).

3.2.3 Axia130 Sensor Cable (P/N 9105-C-ZC28-ZC28)

Table 3.6—ZC28 Connector, M12, 8-pin, Female		
Connector Schematic	Pin Number	Signal
	1	Clock Sync Ground ¹
	2	V +
	3	V - / Ground
	4	Tx -
	5	Rx +
	6	Tx +
	7	Clock Sync ¹
	8	Rx -
	Shell	Shield
<p>Note:</p> <p>1. This connection is optional and is not required for basic functionality. If not using the clock sync functionality, these lines do not need to be connected to anything in the user's system. For more information about the clock sync functionality, refer to Section 4.1—Clock Sync Functionality.</p>		

Table 3.7—ZC28 Connector, M12, 8-pin, Male		
Connector Schematic	Pin Number	Signal
	1	Clock Sync Ground ¹
	2	V +
	3	V - / Ground
	4	Tx -
	5	Rx +
	6	Tx +
	7	Clock Sync ¹
	8	Rx -
	Shell	Shield
<p>Note:</p> <p>1. This connection is optional and is not required for basic functionality. If not using the clock sync functionality, these lines do not need to be connected to anything in the user's system. For more information about the clock sync functionality, refer to Section 4.1—Clock Sync Functionality.</p>		

3.3 Set-up of the RS422 Communication Interface

The RS422 Axia sensor is a serial device that is used programmatically with the user's application.

When the sensor is attached via cable to the customer's device such as a personal computer or robot, the computer assigns the sensor a COM port. Then by using a console on the computer, the user can communicate with the sensor. Free console software, such as PuTTY, is available online. Commands are covered in [Section 5—RS422 Commands](#) and [Section 6—RS422 Axia Sensor "Robot Mode"](#).

If, rather than a personal computer console, the customer chooses to use their own software application to communicate with the RS422 Axia sensor, refer to [Section 7—Pseudocode Example](#). This example depends on the user's software application language.

For additional instructions on setting up a console like PuTTY, refer to the following procedure:

1. If an RS422 serial port is not on the customer device, use a third party serial device to add the port.
Examples of a third party serial device include: a high-speed USB to an RS422 adapter module, or a PCI/PCI-E/PCI-X RS422 serial card.
2. Connect the RS422 cable from the Axia F/T sensor configuration to the RS422 serial port.
3. Find the COM port that is assigned to the Axia sensor device.
 - In Windows®, from the Control Panel go to the Device Manager > **ports** > **USB Serial Port**. The sensor is assigned **COM6** in the following figure.

NOTICE: The name of the device may differ based on the name of the PC's RS422 port or name of the third-party RS422 device.

Figure 3.1—Device Manager, Port Assignment

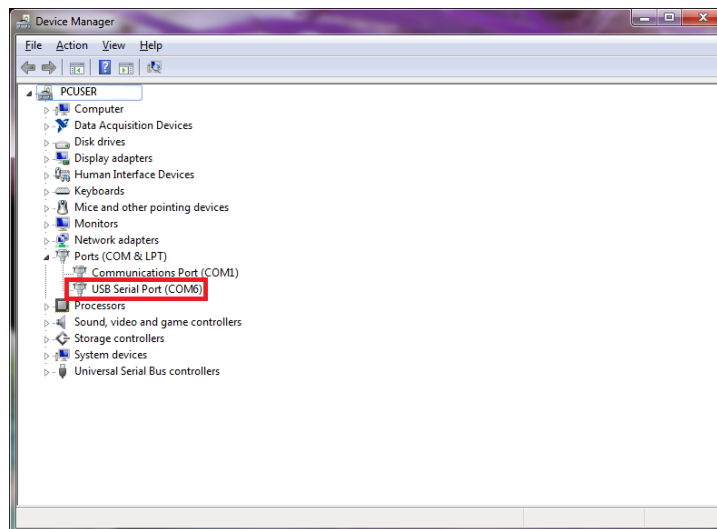

4. Open the console, for example: PuTTY. A window opens that allows the user to set the configuration for the session.

5. Set the configuration:
 - a. Under **Connection type**: select the radio button for **Serial**.

Figure 3.2—Set the Connection Type to Serial

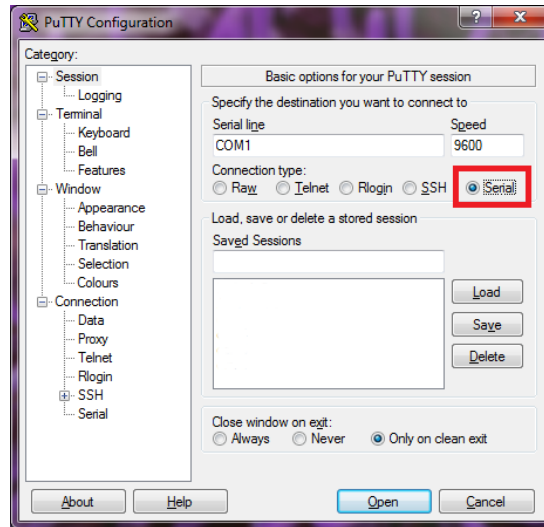

- b. In the **Serial Line** field, enter the assigned COM port from step 3.
- c. In the **Speed** field, enter the default baud rate of 115200 or the baud rate to which the user has set the RS422 Axia sensor. Refer to [Section 5.9—Baud Rate Command: “set baud”](#) for more information on how to set the baud rate.

NOTICE: If the baud rate that is set on the console configuration does not match the baud rate set on the RS422 Axia sensor, then the console terminal window will open but commands cannot be sent. The factory default baud rate is 115200.

Figure 3.3—Set the COM port and the Baud Rate

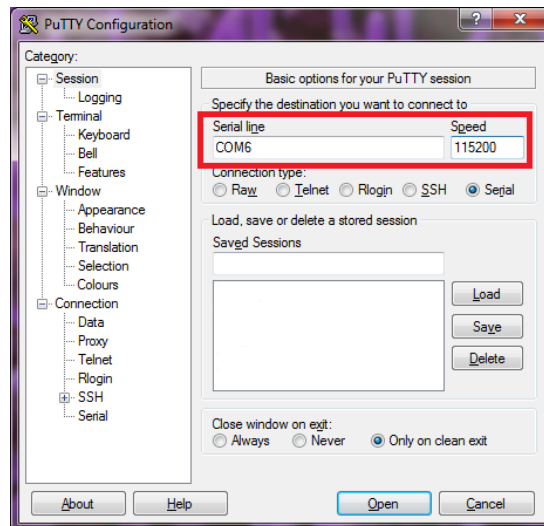

- d. Select **Open**.

- e. After a terminal window opens, the user can then start entering commands.
- f. After a command is entered from [Section 5—RS422 Commands](#) or [Section 6—RS422 Axia Sensor “Robot Mode”](#), press the (enter) key to send the command.

NOTICE: Commands which are entered are not case sensitive.

Figure 3.4—PuTTY Terminal Window

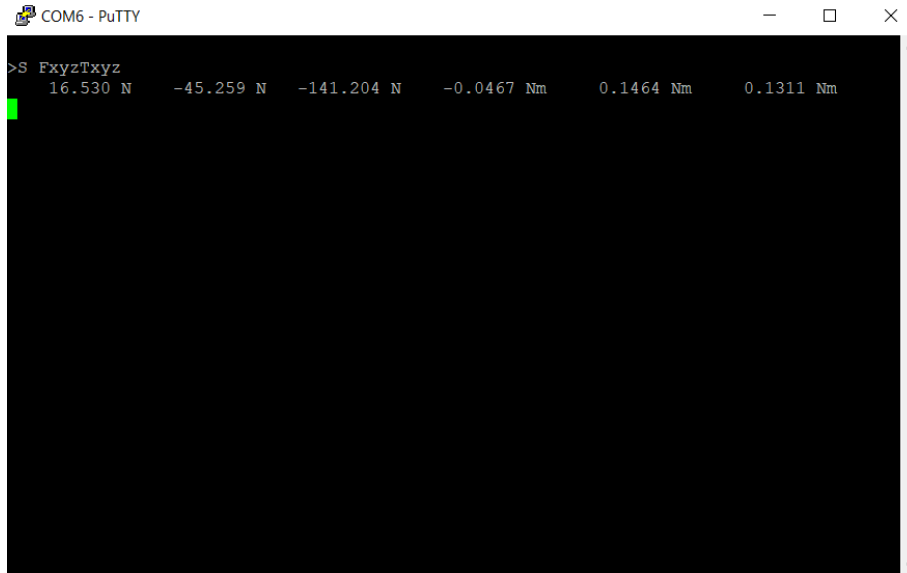

4. Operation

For general operation information about the sensor, refer to the appropriate sensor manual in [Table 2.1](#).

4.1 Clock Sync Functionality

Clock sync functionality activates when the user applies a rising edge of at least 5 V to the conductors (refer to [Section 3.2—Pin and Wire Assignments for Connectors](#)). Upon activation of the sync function, the sensor outputs the most recently collected data point which is equivalent to the output from the “s” command ([Section 5.3—Query Commands: “S” or “C”](#)) sent over an RS422 cable interface.

An electrical pulse is shown in the following figure. The rising edge of the pulse starts at 5 V. The falling edge of the pulse is when the voltage is no longer within 5-12 V. 12 V is the maximum voltage that the cable allows. The sync functionality is no longer activated when the voltage is outside the 5-12 V range.

Figure 4.1—Electrical Pulse

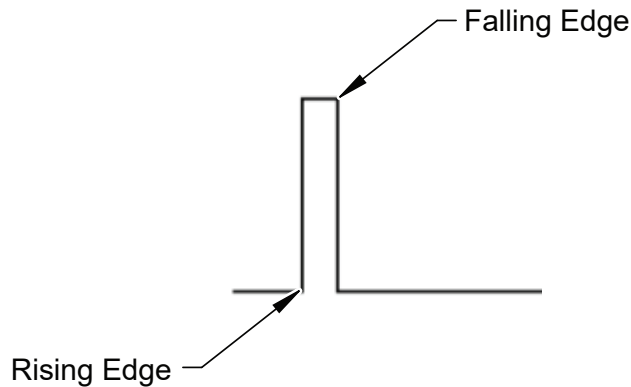

4.2 LED Self-Test Sequence

The RS422 Axia sensor has three LEDs: Sensor Status, Link/Activity, and Diag. When the user applies power, the sensor completes a self-test, during which the LEDs under firmware control turn-on individually.

Table 4.1—LED Self-Test Sequence			
Sequence Order	LED	State	Duration
0	All	At power on, some transient activity may be seen for only a few milliseconds.	
1	All	Off	Approximately one second for each state.
2	Status	Red	
3	Diag	Red	
4	L/A	Red	
5	Status	Green	
6	Diag	Green	
7	L/A	Green	
8	All	Off	
9	All	Normal Operation	

Figure 4.2—LED Label on the Sensor

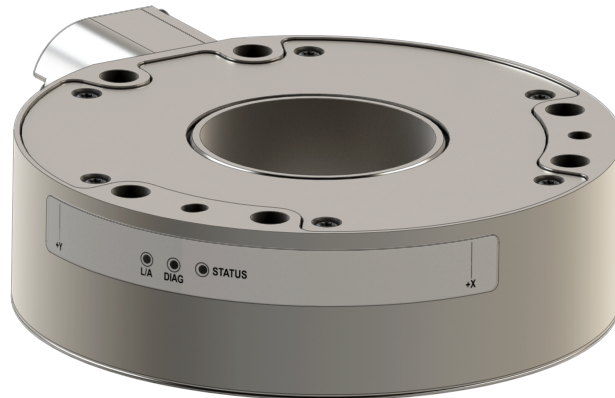

4.3 LED Normal Operation

4.3.1 Sensor Status LED

One LED signals the health status of the sensor as follows:

Table 4.2—Sensor Status LED		
LED Color	State	Description
Off	No power	Electricity is not supplied to the sensor.
Green	Normal Operation	The sensor's electronics are functioning and communicating.
Amber ¹	Sensing range exceeded	Indicates that a F/T axis is out of range. Reduce the applied load or use a larger calibration if available.
Red (flash at 1 Hz speed)	Calibration error	Calibration was not stored in the EEPROM.
Red (flash at 10 Hz speed)	Communication error	The sensor is not able to communicate data over the communication protocol.
Red (solid)	Status code error	For more information on the error set, refer to Table 4.7 .
Note:		
1. Amber is when both green and red LEDs are on.		

4.3.2 Diag LED

One LED signals the diagnostic status of the RS422 Axia sensor interface as follows:

Table 4.3—Diag LED		
LED Color	State	Description
Green Blinking	Pre-operational	Defined by the communication/protocol standard.
Green	Operational	No errors are found.
Red	Error	Indicates an error reported by the internal electronic components. After a UART error, the LED stays red for five seconds.

4.3.3 RS422 Link/Activity (L/A) LED

All ATI Axia sensors include Link/Activity LEDs. However, the L/A LEDs are not active on RS422 sensors.

4.4 Sample Rate

The power-on default sample rate is the rate the user sets before removing power. The sample rate is stored to nonvolatile memory. The ADC rate controls the current sample rate. The following table lists the rounded and exact sample rates.

Table 4.4—Sample Rate					
Rounded Sample Rate	0.5 kHz	1 kHz	2 kHz	4 kHz	8 kHz
Exact Sample Rate	488 Hz	976 Hz	1953 Hz	3906 Hz	7912 Hz

4.4.1 Sample Rate Versus Data Rate

The data rate is how fast data can be output over the RS422 interface.

If the data rate is faster than the sample rate, the customer sees duplicate samples output over the network until the next sample is read internally. A faster data rate could be useful so that the sensor sends data at the same rate that other devices in a customer’s system are outputting. For example: if a device on the same application as the Axia is outputting data at 7,000 Hz, the customer may want the Axia to be outputting data to the network at 7,000 Hz as well, even though the sensor is not sampling that quickly internally.

If the sample rate is faster than the data rate, the customer does not receive the data from every internal sample over the network. However, any filters that are enabled work based on the internal sample rate, so the sensor filters out higher frequency noise sources.

4.5 Low-Pass Filter

The power-on default selection is “no filtering.” The “set” filTC field (refer to [Table 5.3](#)) controls the current filter selection. The cutoff frequency (for example: -3 dB frequency) is dependent on the sample rate selection, which is defined in [Section 4.4—Sample Rate](#). The cutoff frequencies for the different sampling rates are listed in the following table.

Table 4.5—Low-Pass Filtering					
Selected Filter	-3dB Cutoff Frequency (in Hz)				
	at 488 Hz Sample Rate	at 976 Hz Sample Rate	at 1953 Hz Sample Rate	at 3906 kHz Sample Rate	at 7912 Hz Sample Rate
0	200	350	500	1000	2000
1	58	115	235	460	935.10
2	22	45	90	180	364.04
3	10	21	43	84	169.52
4	5	10	20	40	81.24
5	2.5	5	10	20	39.84
6	1.3	3	5	10	20.31
7	0.6	1.2	2.4	4.7	9.37
8	0.3	0.7	1.4	2.7	5.47

Figure 4.3—Filter Attenuation at 0.5 kHz Sample Rate

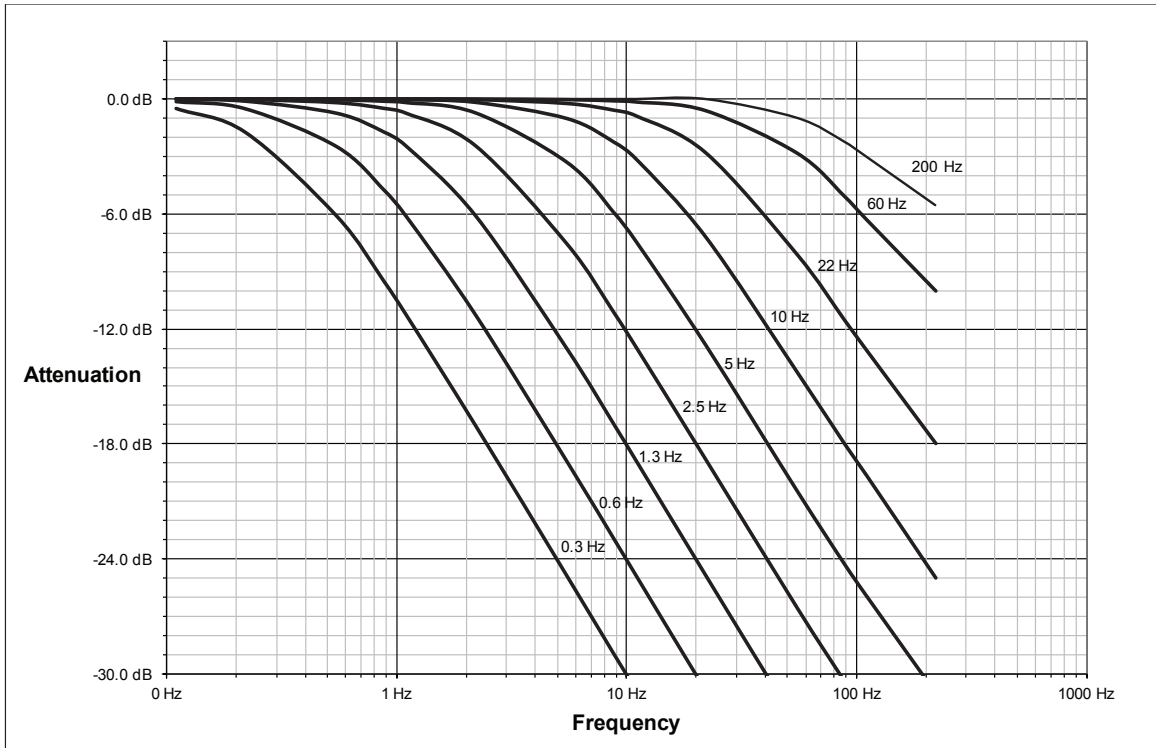

Figure 4.4—Filter Attenuation at 1 kHz Sample Rate

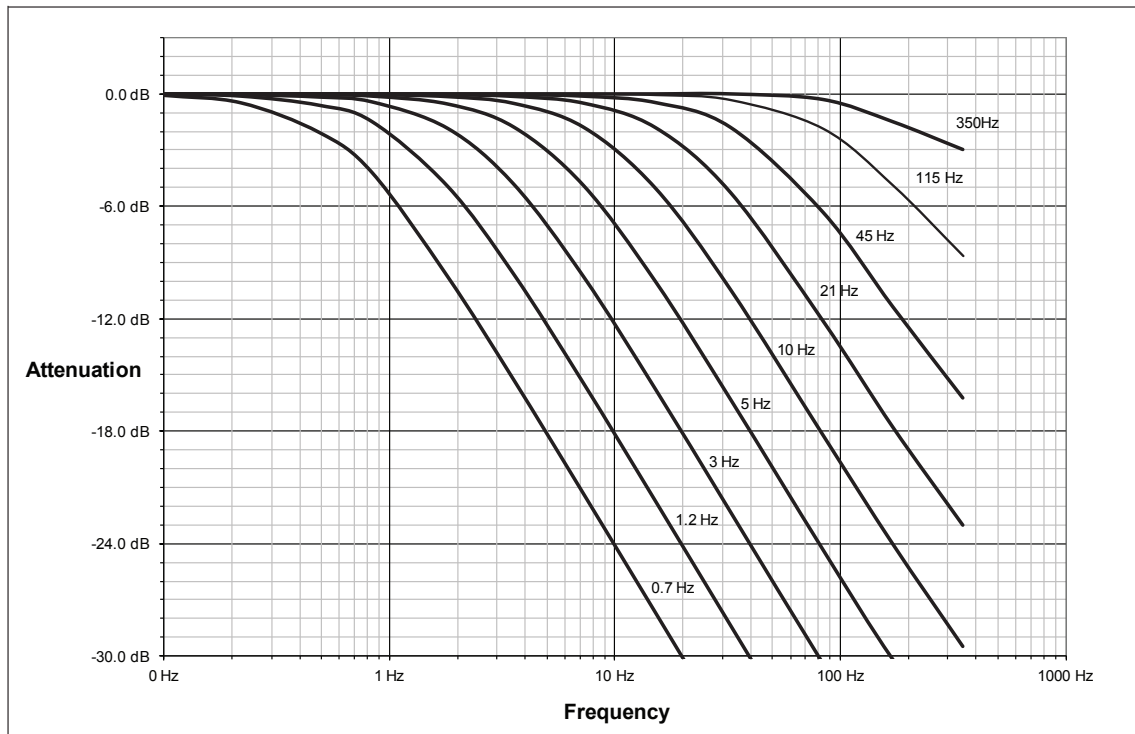

Figure 4.5—Filter Attenuation at 2 kHz Sample Rate

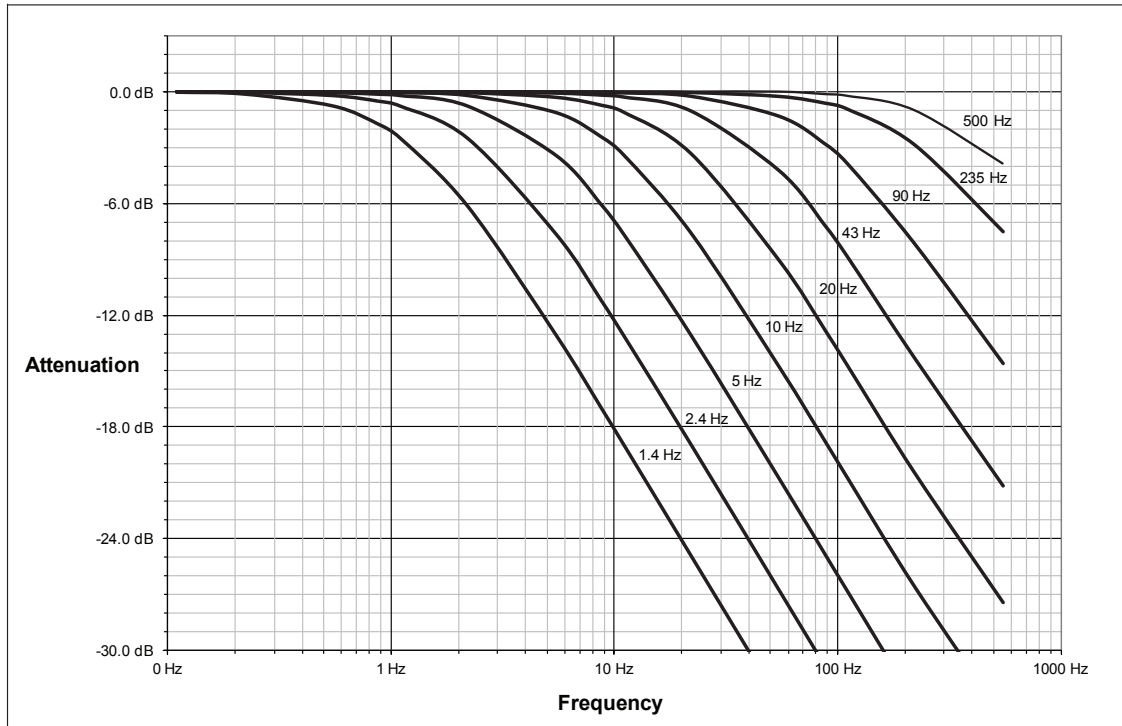

Figure 4.6—Filter Attenuation at 4 kHz Sample Rate

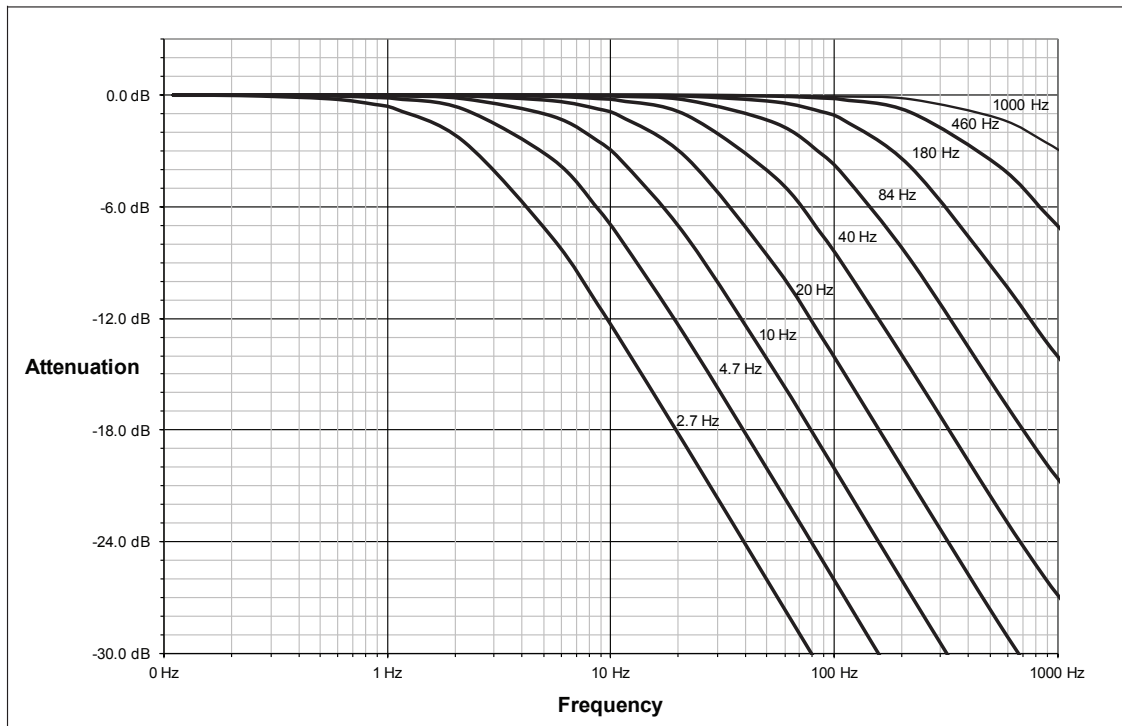
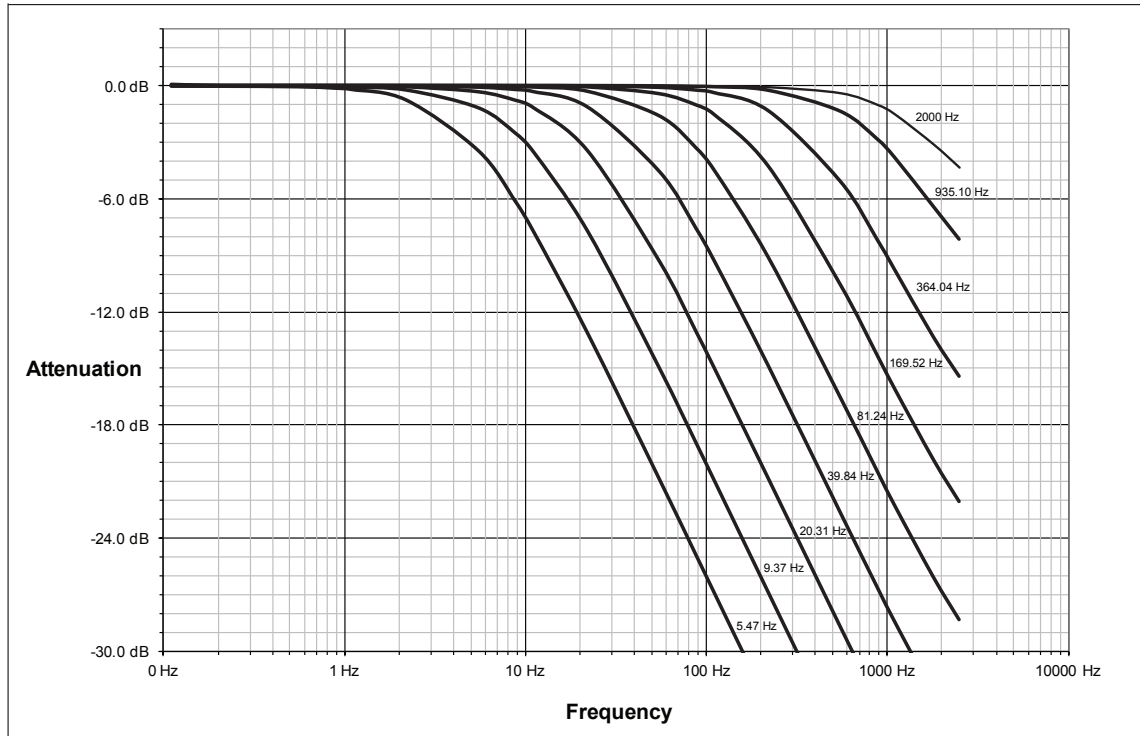

Figure 4.7—Filter Attenuation at 8 kHz Sample Rate



4.6 Status Code

A bitmap from bit number 0 to 31 for the current condition of the sensor is in the following table. The user can retrieve the status code using the RS422 commands (refer to [Section 5.3.4—How to Interpret the Output from “!” Specifier](#)).

Table 4.6—Status Code		
Bit Number	Description	Indicates an Error?
0	Internal Temperature Out of Range: This bit is active (high) if the temperature is outside the range -5° to 70°C.	Yes
1	Supply Voltage Out of Range: This bit is active (high) if the input voltage is outside the range of 12 V to 32 V.	Yes
2	Broken Gage: This bit is active (high): <ul style="list-style-type: none"> • A gage reads positive full scale and indicates that the electrical connection to a gage is open or disconnected. • The sensor reports loads significantly higher than its sensing range. It self resets 32 sample periods after the condition clears.	Yes
3	Busy Bit: The sensor is performing (1) or more of the following activities that may temporarily affect the F/T data: <ul style="list-style-type: none"> • Committing a change to NVM. • Changing the filter time constant. • Changing the calibration in use. • Changing the ADC sampling rate. • Any ADC ISR overrun. 	No
4	Reserved.	N/A
5	Other Error Bit: This bit is set whenever an error other than those specified in this table exists.	Yes
6 to 26	Reserved.	N/A
27	Gage Out of Range: This bit is set whenever a gage sample is outside of the range gageMinRange to gageMaxRange. It self resets 32 sample periods after the condition clears.	Yes
28	Simulated Error: This bit is used to test user error handling.	No
29	Calibration Checksum Error: This bit is set if the active calibration has an invalid checksum.	Yes
30	Force/Torque Out of Range or Sensing Range Exceeded: This bit is active whenever the force/torque sample is out of range or saturated. It self resets 32 sample periods after the condition clears.	Yes
31	Error: This bit is set whenever any status code bit that indicates an error is set.	Yes

4.6.1 Status Code: Force/Torque Out of Range or Sensing Range Exceeded

Bit 30 in [Table 4.7](#) is set when an F/T load is outside the sensor's detection capability. Bit 30 is set when either of the following conditions are TRUE:

- The total percentage of the calibrated range used by F_{xy} and T_z axes is greater than 105%. Refer to the following F_{xy} T_z equation:

$$\frac{\sqrt{F_x^2 + F_y^2}}{F_{XY} \text{CalibratedRange}} + \frac{|T_z|}{T_z \text{CalibratedRange}} > 105\%$$

- The total percentage of the calibrated range used by F_z and T_{xy} axes is greater than 105%. Refer to the following F_z T_{xy} equation:

$$\frac{|F_z|}{F_z \text{CalibratedRange}} + \frac{\sqrt{T_x^2 + T_y^2}}{T_{XY} \text{CalibratedRange}} > 105\%$$

- For Example:

An Axia90-M50 sensor that uses calibration range 0 is subjected to the following loads and has the following calibration ranges (Note: for calibration ranges, refer to the appropriate sensor manual in [Table 2.1](#)):

Axis	Applied Load	Calibration Range 0 Value
F_x	170.5 N	1000 N
F_y	-300.6 N	1000 N
F_z	-1400 N	2000 N
T_x	1.0 Nm	50 Nm
T_y	2.0 Nm	50 Nm
T_z	-45.5 Nm	50 Nm

The F_{xy} T_z equation simplifies as follows:

$$\frac{\sqrt{(170.5 \text{ N})^2 + (-300.6 \text{ N})^2}}{1000 \text{ N}} + \frac{|-45.5 \text{ Nm}|}{50 \text{ Nm}}$$

$$\frac{346 \text{ N}}{1000 \text{ N}} + \frac{45.5 \text{ Nm}}{50 \text{ Nm}}$$

$$35 \% + 91 \%$$

$$126 \% > 105 \%$$

TRUE

The $F_z T_{xy}$ equation simplifies as follows:

$$\frac{|-1400 \text{ N}|}{2000 \text{ N}} + \frac{\sqrt{(1.0 \text{ Nm})^2 + (2.0 \text{ Nm})^2}}{50 \text{ Nm}}$$

$$\frac{1400 \text{ N}}{2000 \text{ N}} + \frac{2.24 \text{ Nm}}{50 \text{ Nm}}$$

$$70 \% + 4.5 \%$$

$$74.5 \% \neq 105 \%$$

FALSE

Because the $F_{xy} T_z$ equation simplified to TRUE, bit 30 in [Table 4.7](#) is set.

5. RS422 Commands

These commands can be used to view the status, parameters, and adjust settings of the sensor. For setting up a console, refer to [Section 3.3—Set-up of the RS422 Communication Interface](#).

5.1 Help Command: “help”, “h”, or “?”

The help command reports a list of the main commands and software version.

“h” command format:

user: h

response:

```
=====
ATI Industrial Automation ATI Axia F/T Sensor
Version: 1.0.73 => Aug  3 2021 14:39:50 BL=4 locally-built
=> Enter most commands without operands to display current status.
=====
HELP      [string] => Print help for commands that start with the given string
SYSVER    => Print version
WHOAMI    => Print console input source
BIAS      [ON | OFF | <values>] => Control user bias
PEAK      [R | C] => View, Reset runtime peaks, display in Counts
SET       => Print all fields
|         [field-name] => Print matching field(s)
|         [field-name] [value] => Write field with value
VIEW      [0 -> 2 | A] => View calibrations: 0 to 2, or Active
DIAG      => Diagnostic status report
SIMERR    [ON | OFF] => Control simulated error
RESET     => Reset the MCU
STATUS    => Print Status Report
PINS      => Print Pins report
GPIO      => Print GPIO configuration report
SAVEALL   => Save all parameters to NVM
C         [HDB01234567FTXYZMS in any order] => Continuous mode
|         0->7=gages
|         XYZ=Forces/Torques M=Magnitude C=Counts U=Units H=Hex
|         D=Decimal B=Binary F=Force T=Torque '>'=condensed '<'=formatted
|         S=checksum #=LineCounter @=ADC_SampleCounter !=StatusWord
|         ;=Comma Delimiter -- Press multiple keys to exit
S         => Single Sample, same format as Continuous mode
FLOW      => Signal Flow Report
MC        => Print all monitor conditions
UART      => Print last bytes received report
=====
```

5.2 Reset Sensor Command: “reset”

The “reset” command resets the MCU.

“reset” command example format (the response varies per configuration of the system):

user: reset

response:

BL4I0+I1+C=

=====

RESET due to: SoftwareReset

I2C EEPROM verified

0.000 N 0.000 N 0.000 N 0.0000 Nm 0.0000 Nm 0.0000 Nm

5.3 Query Commands: “S” or “C”

The query command starts the high-speed data transmission of FT data. The ”S” command reports a single line of FT data that is scaled by the counts per force or counts per torque. The “C” command reports continuous lines of FT data that stop when the user holds another key, for example: “enter”, until the output of data ceases. The “C” command reports data at the rate specified in the rdtRate. The data reported by issuing a query command can be adjusted as detailed in the following section.

Query “S” command format:

user: S

response: > 34.928 N 10.234 N -0.370 N -0.1196 Nm -0.0787 Nm -0.9156 Nm

Query “C” command format:

user: C

response: > 34.946 N 10.277 N -0.398 N -0.1179 Nm -0.0791 Nm -0.9163 Nm

34.915 N 10.290 N -0.419 N -0.1179 Nm -0.0793 Nm -0.9154 Nm

34.922 N 10.253 N -0.397 N -0.1185 Nm -0.0783 Nm -0.9159 Nm

...

...

...

user: <presses another key such as ‘Enter’ to stop the data transmission >

No return data.

5.3.1 Converting Counts Per Force/Torque to FT Values

To obtain the real force and torque values, each force value must be divided by the counts per force (cpf) factor, and each torque value must be divided by the counts per torque (cpt) factor. For example: if a calibration reports 1,000,000 counts per N and the F_z reports 4,500,000 counts, then the force applied in the Z axis is 4.5 N.

Find the cpf and cpt factors using the “set” command; refer to [Section 5.7—Set Command: “set”](#).

5.3.2 Secondary Commands for the Query “C” or “S” Command

The type of data reported from the query “C” or “S” command can be adjusted using secondary commands or specifiers. This feature is useful for users who want to develop their own program for storing the data to an external file or view the data in figures such as charts. A list of secondary commands is in [Table 5.1](#).

If a “S” or “C” command is issued without a specifier(s), the specifier(s) from the previous “S” or “C” command is used in the data print out. The power-on default specifier is the following: “FXYZTXYZ”.

Table 5.1—Secondary “S” or “C” Commands		
Category	Secondary Command or Specifier	Notes
Gage number(s)	0	Gage values are printed in counts only. As many as all gage numbers can be reported or as few as a single gage number.
	1	
	2	
	3	
	4	
	5	
	6	
	7	
Axis	X	The user can choose to view force and torque data in the x, y, z axis. The output value can be displayed in F/T counts or engineering units. Counts are converted to units by scaling or dividing the count value by the cpf or cpt. Refer to Section 5.3.1—Converting Counts Per Force/Torque to FT Values .
	Y	
	Z	
Force and/or Torque	F	The XYZM force data is displayed.
	T	The XYZM torque data is displayed.
Magnitude	M	Force or torque data is displayed as the magnitude of the vector components in the x, y, and z axis. The output value can be displayed in F/T counts or engineering units. Counts are converted to units by scaling or dividing the count value by the cpf or cpt. Refer to Section 5.3.1—Converting Counts Per Force/Torque to FT Values .
Counts or Units	C	The XYZM data is displayed in counts.
	U	The XYZM data is displayed with the selected user units, for example: N or Nm. Units are the default setting.
Numeric System	H	The data is displayed as a hexadecimal number. Except any data printed in units is always displayed as a decimal number by default.
	D	The data is displayed as a decimal number.
Format	>	The data is displayed in a formatted human-readable output, for example: lined-up columns. “>” is the default setting.
	<	The data is displayed in a compressed output that has no leading zeros, trailing zeros, or unnecessary blanks. This output is intended for high-speed applications that are used in an automated setting.
Additional inputs to aid in the development of a software program	S	This command specifies a CRC.
	#	This command specifies a sample counter that is incremented each time that a “c” or “s” line is printed.
	@	This command specifies an ADC read counter that is incremented each time that the ADC is read.
Troubleshooting	!	This command specifies the 32-bit status code. Refer to Section 5.3.4—How to Interpret the Output from “!” Specifier .

5.3.3 Examples of Secondary Commands (Specifiers)

The following are examples of an “S” or “C” command with specifiers:

1. C XTY is interpreted as:

```
user:          C XTY
response:      0.001 N      0.0009 Nm
```

- a. The C is a command for reporting continuous lines of data.
- b. The X specifies printing F_x , because force is the default.
- c. The T specifies printing torques whenever an X, Y, Z, or M is seen from now on (on this line).
- d. The Y specifies printing T_y .

2. C TXY is interpreted as:

```
user:          C TXY
response:      0.0009 Nm    0.0009 Nm
```

- a. The C is a command for reporting continuous lines of data.
- b. The T specifies printing torques whenever an X, Y, X, or M is seen from now on (on this line).
- c. The X specifies printing T_x .
- d. The Y specifies printing T_y .

3. S D0123 is interpreted as:

```
user:          S D0123
response:      246123  245592  246707  246029
```

- a. The S is a command for reporting a single line of data.
- b. The D specifies printing raw ADC values in counts decimal.
- c. A number 0 through 7 specifies to print the data for the corresponding gage number. For example, the 0 specifies to print data for gage 0, and the 3 specifies to print data for gage 3.

4. S CDFXYZTXYZ is interpreted as:

```
user:          S CDFXYZTXYZ
response:      961    959    963    960    966    965
```

- a. The S is a command for reporting a single line of data.
- b. The C and D specifies printing x, y, z, or m F/T data in counts decimal.
- c. The F specifies printing torques whenever an X, Y, Z, or M is seen from now on (on this line).
- d. The T specifies printing the torques whenever an X, Y, Z, or M is seen from now on (on this line).

5.3.4 How to Interpret the Output from “!” Specifier

The output from “!” specifier reports an output in hexadecimal that must be converted to a 32-bit binary number that correlates to a status code from [Table 4.7](#). Refer to the following table for an example of bit patterns:

Bit Number	Simple Description Refer to Table 4.7 .	Bit Pattern
0	Temperature	0x80000001
1	Supply voltage	0x80000002
2	Broken gage	0x80000004
3	Busy bit	0x80000008
4	Reserved	N/A
5	Other	0x80000020
6 to 26	Reserved	N/A
27	Gage out of range	0x88000000
28	Simulated error	0x10000000
29	Calibration checksum error	0xA0000000
30	F/T out of range	0xC0000000
31	Any error	0x80000000
--	Healthy	0x00000000

If there is more than one error present, the bit pattern can be different, for example:

user: S !
 response: 80000005

Using a free online calculator, the user can convert the hexadecimal number to a binary number:

Hex	8	0	0	0	0	0	0	5
Binary	1000	0000	0000	0000	0000	0000	0000	0101

The binary number has 32-bits total. The least significant bit is on the right end of the following table. “1” means the bit is on. “0” means the bit is off.

Binary Number	1	0	0	0	0	000	0000	0000	0000	0000	00	0	0	0	1	0	1
Bit Position	31	30	29	28	27	26 to 6						5	4	3	2	1	0

So in this example, bit number 0, 2 and 31 are on. According to the preceding table, the sensor has a “temperature”, “broken gage error”, and “any error” status codes. For more information, refer to [Table 4.7](#).

5.4 Bias Command: “bias”

The “bias” command reports the current bias status of the sensor.

“bias” command format:

```
user:      bias
response:  BIAS OFF
```

In this case, the command reports the status that the bias feature is off.

5.4.1 Secondary Bias Commands: “on”, “off”, “[values]”

The secondary commands allow the user to turn the bias feature on and off. Turning the feature on, sets the FT output to 0. Turning the feature off, clears the bias bit. Also, the user can bias the sensor with user determined values.

“bias” command format for turning the feature “on” or “off”:

```
user:      bias on
response:  BIAS ON
```

“bias” command format for turning the feature on with values that are determined by the user:

```
user:      bias [values]
response:  BIAS
```

5.5 Peak Command: “peak”

The “peak” command reports the highest and lowest values of $F_x \setminus F_y \setminus F_z \setminus T_x \setminus T_y \setminus T_z$ that occurred for a run-time and for all-time. The peak reset command resets the run-time peaks only.

All time peaks are largest values seen while the sensor was powered on and operating. When the sensor is powered on, the sensor records the peak values detected on any single axis. If the sensor detects all-time peak values higher than the ATI factory defaults, the sensor was loaded past the intended calibrated sensing range. For the ATI factory default all-time peak values (listed in Counts), refer to the applicable Axia sensor manual in [Table 2.1](#). For similar commands, refer to the following sections: [Section 5.5.1—Peak Command in Counts: “peak C”](#) and [Section 5.5.2—Peak Reset Command: “peak reset”](#).

“peak” command format:

```
user:      peak
response:  F/T    Units    RunPeak-    RunPeak+    AllPeak-    AllPeak+
           ---     -
           Fx      N      34.205     35.264     -750.000    750.000
           Fy      N       7.573     10.596     -750.000    750.000
           Fz      N      -4.591     3.248     -1350.000   1350.000
           Tx      Nm     -0.157     0.071     -30.000     30.000
           Ty      Nm     -0.138     -0.042     -30.000     30.000
           Tz      Nm     -0.952     -0.890     -30.000     30.000
```

5.5.1 Peak Command in Counts: “peak C”

The “peak c” command reports the highest and lowest of $F_x \setminus F_y \setminus F_z \setminus T_x \setminus T_y \setminus T_z$ in counts that occurred for a run-time and for all-time. The peak reset command resets the run-time peaks only.

All time peaks are largest values seen while the sensor was powered on and operating.

“peak c” command format:

```

user:      peak C
response:  F/T    Units  RunPeak-  RunPeak+  AllPeak-  AllPeak+
          ---    -
          Fx    counts  22774    148876    -345426   1067466
          Fy    counts  -136938  -15879    -2565031  5115055
          Fz    counts  -90228856 -89963912 -91565040  0
          Tx    counts  -8214    -5740    -66667    17719
          Ty    counts  -7288    -4711    -10387    68340
          Tz    counts  22306    26798    -2995     74981
  
```

5.5.2 Peak Reset Command: “peak reset”

The highest and lowest values of $F_x \setminus F_y \setminus F_z \setminus T_x \setminus T_y \setminus T_z$ that occurred for a run-time can be set to the following values by using the “peak reset” command.

“peak reset” command format:

```

user:      peak reset
response:  F/T    Units  RunPeak-  RunPeak+  AllPeak-  AllPeak+
          ---    -
          Fx    N      2147.484  -2147.484  -750.000   750.000
          Fy    N      2147.484  -2147.484  -750.000   750.000
          Fz    N      2147.484  -2147.484  -1350.000  1350.000
          Tx    Nm     2147.484  -2147.484  -30.000    30.000
          Ty    Nm     2147.484  -2147.484  -30.000    30.000
          Tz    Nm     2147.484  -2147.484  -30.000    30.000
  
```

5.6 Save All Command: “saveall”

The “saveall” command records all values that remain through a power cycle to NVM.

“saveall” command format:

```

user:      saveall
response:  Parameters saved to NVM bank 0
           Parameters saved to NVM bank 1
  
```

5.7 Set Command: “set”

The “set” command reports all settings. Note that “CAL” is synonymous for “set”, but in this manual, the command is referenced to as “set”. Many settings are read-only fields that are configured onto the sensor during ATI factory calibration. All setting fields are listed in [Table 5.3](#).

“set” command format, for example:

```
user:      set
response:  Field                               Value
          -----
          serialNum                           FT22835
          partNum                             SI-150-8
          calFamily                           RS422
          ...
```

To read a stored parameter in NVM for a field from [Table 5.3](#), type “set [field]”, for example:

```
user:      set cpf
response:  Field                               Value
          -----
          cpf                                  100000
```

A secondary “set” command allows the user to write or edit the stored parameter in a certain field in [Table 5.3](#). The “set” command is synonymous with a “cal” command. All write commands are temporary until a “saveall” command is issued. When a “saveall” command is given, the parameter is stored in NVM.

Table 5.3—“set” Fields					
Field	Long Name	User Read/Write	Description (and if applicable, Secondary Commands)	Example Contents	Type
serialNum	FT Serial	Read	The FT serial number	FT33859	STRING(8)
partNum	Calibration Part Number	Read	The calibration part number	SI-150-8	STRING(30)
calFamily	Calibration Family	Read	The field always reads “RS422”.	RS422	STRING(8)
calTime	Calibration Time	Read	The date and time the sensor was calibrated.	9/21/2021	STRING(30)
max0	Max F _x Counts	Read	The maximum rated value for this axis, in F/T counts.	111369318	32-bit unsigned integer
max1	Max F _y Counts				
max2	Max F _z Counts				
max3	Max T _x Counts				
max4	Max T _y Counts				
max5	Max T _z Counts				

Table 5.3—"set" Fields					
Field	Long Name	User Read/Write	Description (and if applicable, Secondary Commands)	Example Contents	Type
forceUnits	Force Units		Force units, secondary commands: 0 = Lbf 1 = N 2 = Klbf 3 = kN 4 = Kg	1	8-bit unsigned integer
torqueUnits	Torque Units	Read	Torque units, secondary commands: 0 = Lbf-in 1 = Lbf-ft 2 = Nm 3 = Nmm 4 = Kg-cm 5 = kN-m	2	
cpf	Counts per Force	Read	Calibration counts per force unit.	1000000	32-bit unsigned integer
cpt	Counts per Torque		Calibration counts per torque unit.		
peakPos0	PeakLoadsPosF _x	Read	All-time peak positive force/torque loads that are in F/T counts.	225000000	
peakPos1	PeakLoadsPosF _y			225000000	
peakPos2	PeakLoadsPosF _z			705000000	
peakPos3	PeakLoadsPosT _x			12000000	
peakPos4	PeakLoadsPosT _y			12000000	
peakPos5	PeakLoadsPosT _z			12000000	
peakNeg0	PeakLoadsNegF _x	Read	All-time peak negative force/torque loads that are in F/T counts.	-225000000	
peakNeg1	PeakLoadsNegF _y			-290524128	
peakNeg2	PeakLoadsNegF _z			-1215670272	
peakNeg3	PeakLoadsNegT _x			-12000000	
peakNeg4	PeakLoadsNegT _y			-12000000	
peakNeg5	PeakLoadsNegT _z			-12000000	
sensorHwVer	N/A	Read	The version of the sensor hardware	0	16-bit integer
adcRate	N/A	Read and Write	The ADC update rate in Hz. The ADC rate must be one of the following in units of Hz: 488 976 1953 3906 7812	976	16-bit integer

Table 5.3—"set" Fields					
Field	Long Name	User Read/Write	Description (and if applicable, Secondary Commands)	Example Contents	Type
rdtRate	N/A	Read and Write	The RDT transmission rate in units of Hz. The RDT transmission rate must be 1 to the adcRate.	333	16-bit integer
rdtSize	N/A	Read and Write	The number of RDT records to include in each UDP packet that is transmitted.	1	
filTc	N/A	Read and Write	The IIR filter shift value.	0	8-bit integer
calib	N/A	Read and Write	The calibration to use, secondary commands: 0 or 1 This bit controls which of the two sets of calibrations are displayed in the preceding fields.	0	
location	N/A	Read and Write	Display the physical location of the sensor.	Alex's Bench	String(40)
serNum	N/A	Read	The serial number	Serial number	String(100)
hwProdCode			The hardware product code	HW Product Code	String(20)
ttdu	N/A	Read and Write	Tool transformation distance units, secondary commands: 0 = in 1 = ft 2 = mm 3 = cm 4 = m	0	8-bit integer
ttau	N/A	Read and Write	Tool transformation angle units, secondary commands: 0 = degrees 1 = radians	0	
ttdx	D_x	Read and Write	Tool transform distances (in units specified by "ttdu" field)	0	float
ttdy	D_y			0	
ttdz	D_z			0	
ttrx	R_x		Tool transform rotation angles (in units specified by the "ttau" field)	0	
ttry	R_y			0	
ttrz	R_z			0	

Table 5.3—"set" Fields					
Field	Long Name	User Read/Write	Description (and if applicable, Secondary Commands)	Example Contents	Type
baud	N/A	Read and Write	UART baud rate. Must be in range from 300 baud to 3M baud. Any baud rate change is temporary until a SAVEALL command is issued.	115200	32-bit integer
msg	N/A	Read and Write	Unprompted error messages, secondary commands: 1 = print unprompted messages 0 = do not print unprompted messages	0	8-bit integer

5.8 Calibration Commands

5.8.1 Calibration Range Command: “set calib”

The user can set the calibration range or index number, where:

0 = calibration range 0.

1 = calibration range 1.

The calibration ranges for the sensor are listed in more detail in the specific ATI sensor manual that is listed in [Table 2.1](#).

“set calib” read and write command format, for example:

```
user:      set calib
response:  Field          Value
          -----
          CALIB          0

user:      set calib 1
response:  calib was 0 now 1
```

5.8.2 View Calibration Command: “view”

The view calibration command reports properties such as F/T part number, units, calibration date, calibration family of a certain calibration or multiple calibrations. The view command can be used in conjunction with a second operand, where:

- 0 = calibration 0
- 1 = calibration 1
- A = active calibration
- (No Operand) = all calibrations

“view” command format, for example:

```
user:      view 0
response:  Field          Contents
          -----
          CalSlot          0
          serialNum        FT22835
          partNum          SI-150-8
          calFamily        RS422
          calTime          2/6/2018
          forceUnits        N
          torqueUnits      Nm
```

5.8.3 Example of Switching Between Calibration Ranges

To safely switch between calibration ranges, use the following procedure as a guide:

1. Read the name of the current active calibration:

```
>set partNum  
Field      Value  
-----  
partNum    SI-150-8
```

2. Read the index number of the current active calibration:

```
>set calib  
Field      Value  
-----  
calib      0
```

3. Set the active calibration to index number 1 (note: "calib" is a writeable field):

```
>set calib 1  
calib was "0" now "1"
```

4. Read the name of the current active calibration:

```
>set partNum  
Field      Value  
-----  
partNum    SI-75-4
```

5. Read the index number of the current active calibration:

```
>set calib  
Field      Value  
-----  
calib      1
```

5.9 Baud Rate Command: “set baud”

The user can set the baud rate of the sensor. The baud rate must be a value from 300 to 3000000.

“set baud” read and write command format:

user: set baud

response:	Field	Value
	-----	-----
	baud	115200

user: set baud 300

response: baud was 115200 now 300

Changing the RS-422 baud rate to 300 now!

Make sure you change your console baud rate to match.

The response “to change your console baud rate to match” refers to the *speed* field in [Figure 5.1](#), which shows PuTTY but may be different if another console is used.

Figure 5.1—Changing the Speed to Match the “set baud” Rate

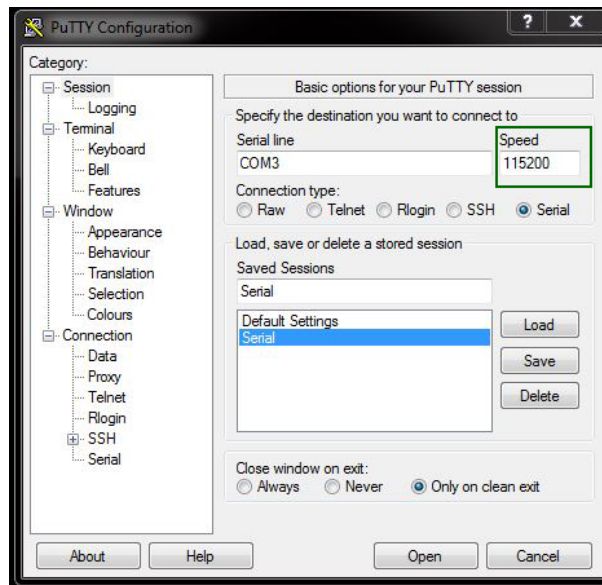

5.10 Simulated Error Command: “simerr”

The “simerr” command refers to bit 28 from [Table 4.7](#). The command can be issued to view status of bit 28 or turn bit 28 on or off. The simulated error command is useful for customers, who need to test their error-handling routines. When a simulated error occurs, the “red” status LED turns on.

“simerr” read command format, for example:

```
user:          simerr
response:      SIMERR ON
```

“simerr” write command format, for example:

```
user:          simerr off
response:      SIMERR OFF
```

5.11 Diagnostic Status Command: “diag”

The diagnostic status command provides a report for each of the gages within the sensor. The information can be compared to the sensor’s calibration range values. Use [Section 5.12—Status Command: “status”](#) for troubleshooting.

“diag” command format:

```
user:          diag
```

response:

Ch	Counts	Axis	Units	F/T	AllPeak-	AllPeak+	ToolTransform
---	-----	----	-----	---	-----	-----	-----
0	-360067	Fx	N	20.890	-225.000	225.000	Dx 0.000 in
1	-383899	Fy	N	-48.897	-290.524	225.000	Dy 0.000 in
2	-431150	Fz	N	-161.278	-1215.670	705.000	Dz 0.000 in
3	-76542	Tx	Nm	-0.015	-12.000	12.000	Rx 0.000 deg
4	-221676	Ty	Nm	0.114	-12.000	12.000	Ry 0.000 deg
5	-215717	Tz	Nm	0.079	-12.000	12.000	Rz 0.000 deg
6	-854279						
7	6252728	-18.3	*C				

5.12 Status Command: “status”

If there could be an underlying problem within the sensor hardware, the “status” command can be used to retrieve detailed information or for the user to send the information to ATI for troubleshooting.

“status” command format (the content may vary among sensors):

user: status

response:

```
Label           Stat Details
-----
NVM-Image-0 Good 182 Kbytes ==
NVM-Image-1 Good 182 Kbytes ==
SPI-EEPROM Good 2048 Kbytes Addr: 24-bit Mfg: Macronix Part: MX25V1635F Tries: 1
SPI-Param-0 Good 1917 bytes
SPI-Param-1 Good 1917 bytes
RAM-Param Good 1917 bytes
MCU-RAM Good 512 Kbytes Errors: 0
Stack Good 376 Kbytes of 379 Kbytes available
Heap Good 120 bytes of 136 bytes available
MCU-Clock Good 168.0 MHz Clock: SYSCLK
REFCLKO2 ---- 14.0 MHz Clock: SYSCLK
SQI1-ECAT ---- 14.0 MHz Clock: REFCLKO2 State: ON
SPI2-ADC ---- 14.0 MHz Clock: PBCLK2 State: ON Bits: 8 CKE: 0 CKP: 1 Timeouts: 0
SPI3-ECAT ---- 28.0 MHz Clock: PBCLK2 State: ON Bits: 8 CKE: 0 CKP: 1 Timeouts: 0
SPI4-EEPROM ---- 2.0 MHz Clock: PBCLK2 State: ON Bits: 8 CKE: 0 CKP: 1 Timeouts: 0
UART1-Main ---- 114.8 KHz Clock: PBCLK2 State: ON brgh: 1 8N1 RS-422 Ovf: 0 Framing: 0 Parity: 0
UART2-SFE ---- 114.8 KHz Clock: PBCLK2 State: ON brgh: 1 8N1 RS-422 Ovf: 0 Framing: 0 Parity: 0
I2C3-EEPROM Good 50.0 KHz BitBang
ISR-TMR1 ---- 1.0 KHz 1.0 usec Max: 3.0 usec Overruns: 0
ISR-TMR5 ---- 1.7 KHz 0.7 usec Max: 2.2 usec Overruns: 0
ISR-ADCM Good 976.6 Hz 34.1 usec Max: 39.8 usec Overruns: 0
ISR-PDI Good 4.3 KHz 0.0 usec Max: 0.4 usec Overruns: 0
ISR-SYNC0 ---- 4.3 KHz 0.0 usec Max: 0.5 usec Overruns: 0
ISR-SYNC1 ---- 4.3 KHz 0.0 usec Max: 0.4 usec Overruns: 0
ISR-CLKSYNC ---- 4.3 KHz 0.0 usec Max: 0.5 usec Overruns: 0
StreamOut ---- 27.9 Hz 9.1 usec Max: 135.8 usec Overruns: 0
Background ---- 248.5 KHz 4.1 usec Max: 17.2 msec Overruns: 0
Firmware ---- 9031-05-1065 1.0.73 => Aug 3 2021 14:39:50 BL=4 locally-built
Harmony ---- 2.05
Compiler ---- 4.8.3 MPLAB XC32 Compiler v2.05
MCU-Part Good PIC32MZ2048EFH064 A6 S/N: 7e454997 193bf259
MCU-Mode Good Mode=Run Protection=On
MCU-FPU ---- ID=a7 REV=32 UFRP=1 FC=1 HAS08=1 F64=1 L=1 W=1 3D=0 PS=0 D=1 S=1 FS=1 FO=0 FN=0 MAC=0 ABS=1 NAN=1 RM=0
MCU-Cache ---- Inst: Size=16384 bytes Lsize=16 bytes Ways=4 Data: Size=4096 bytes Lsize=16 bytes Ways=4
MCU-WatchDg ---- 2.0 sec Windowed: Off
MCU-RCON BAD WatchdogTimer ERREPC=9d02ac2c
MCU-Supply Good 23.9 V
MCU-IVref Good 1.2 V
MCU-Regs Good
MCU-PC Good
THERM1 ---- -18.3 *C
THERM2 ---- -18.3 *C
THERM3 Good 27.9 *C
ADC-Gages Good Spikes: 2
ADC-RegWr ---- Resets: 3 Fails: 0
EtherCAT ----
MCU-GPIO Good

>
```

6. RS422 Axia Sensor “Robot Mode”

“Robot mode” is not required to communicate with all robots, but it presents the data in a useful format for certain robot integrations. When in “robot mode” the RS422 Axia sensor is able to complete these following actions:

- enter and exit “robot mode”
- print a single reading or continuous reading of FT values
- print the counts per force and counts per torque

In addition to the preceding basic commands, the RS422 Axia sensor is able to complete the following, more advanced actions:

- set either 16-bit or 32-bit output values
- set the ADC sample rate
- set the IIR filter shift value
- set the calibration value
- view the current output bit or calibration value
- bias FT data

For an explanation of each command for entering and exiting “robot mode” and commands for obtaining and manipulating FT data, refer to the following sections. For instructions on setting up a console, refer to [Section 3.3—Set-up of the RS422 Communication Interface](#).

NOTICE: After the user has entered “robot mode”, do not press the (enter) key after issuing a command. As soon as the user types the character, for example “r”, the software recognizes the input command and outputs data. The console does not echo or show the command the user has entered.

6.1 Enter and Exit “Robot Mode”: “M” command

To enter or leave “Robot Mode”, the sensor must first be attached via a USB cable to a serial port on a personal computer. After opening up the console, enter “Robot Mode” by typing the character “M”. Then the sensor can be installed on the robot, for example:

<the user enters “M”>

```
response:  Parameters saved to NVM bank 0
           Parameters saved to NVM bank 1
```

To exit “robot mode”, remove the sensor from the robot. Attach the sensor to a personal computer and open a console. Type the character “M”. For example:

<the user enters “M”>

```
response:  Parameters saved to NVM bank 0
```

6.2 Print a Single Reading of FT Values: “R” command

To receive a single FT reading of each axis, type the character “R”. The output is in hexadecimal. There is not a delimiter between FT values.

The output has the following format: N (record number 0-9), $F_x \setminus F_y \setminus F_z \setminus T_x \setminus T_y \setminus T_z$

To understand how to read these outputs, refer to [Section 6.5—How to Interpret Robot Mode Readings](#).

The “R” command format, for example:

<the user enters “R”>

```
response:  200000000FFFFFFFFFFFFFF0000
```

6.5 How to Interpret Robot Mode Readings

The following is an example of how to interpret “robot mode” FT readings into decimal values.

The “P” counts per force and counts per torque command and “R” single FT reading command have the following outputs:

P = 15.2588, 15.2588, 15.2588, 15.2588, 15.2588, 15.2588

R = 1FFFF00000023000000000000

The “P” command has this format:

Table 6.1—The “P” Command Format					
Counts per F_x	Counts per F_y	Counts per F_z	Counts per T_x	Counts per T_y	Counts per T_z
15.2588	15.2588	15.2588	15.2588	15.2588	15.2588

The “R” command has this format in hexadecimal:

Table 6.2—The “R” and “S” Command Format						
Counter	F_x Counts	F_y Counts	F_z Counts	T_x Counts	T_y Counts	T_z Counts
1	FFFF	0000	0023	0000	0000	0000

Free calculators are available on the internet to convert hexadecimal values to decimal values.

After converting the hexadecimal to decimal, divide the output from the “R” command by the output from the “P” command to obtain human readable F/T values. For example:

$$F_x = \text{FFFF} \div 15.2588 = -1 \div 15.2588 = -0.06554 \text{ N}$$

$$F_y = 0000 \div 15.2588 = 0 \div 15.2588 = 0 \text{ N}$$

$$F_z = 0023 \div 15.2588 = 35 \div 15.2588 = 2.2938 \text{ N}$$

$$T_x = 0000 \div 15.2588 = 0 \div 15.2588 = 0 \text{ N}$$

$$T_y = 0000 \div 15.2588 = 0 \div 15.2588 = 0 \text{ N}$$

$$T_z = 0000 \div 15.2588 = 0 \div 15.2588 = 0 \text{ N}$$

6.6 Other Commands

The following sections list and describe more advanced commands in “robot mode”. All of the commands must be issued while the sensor is connected via an RS422 cable to an RS422 port on a personal computer. After issuing commands to adjust the settings, the sensor can then be installed on a robot. To adjust the settings on the sensor again, the sensor must be removed from the robot.

6.6.1 Set 16 or 32-Bit Output Values for Each Axis: “W” command

Type the character “W” followed by a “2” to select 2 byte or 16-bit output values (4 hexadecimal characters). 16-bit output values are the default setting. Type the character “W” followed by a “4” to select 4 bytes or 32-bit output values (8 hexadecimal characters). For example:

<the user enters “W2”>

```
response: Parameters saved to NVM bank 0
          Parameters saved to NVM bank 1
```

The 32-bit output mode provides the user with more resolution or precision of F/T data than the 16-bit output mode because the 16-bit reading shows the upper 16-bits of the 32-bit reading.

6.6.2 Set the ADC Sample Rate: “A” command

The ADC sample rate that is set for the sensor must match the same sample rate set on the console; refer to [Figure 5.1](#).

Type the character “A” and one of the following values 0 to 4 for ADC sample rate:

- 0 for 488
- 1 for 976
- 2 for 1953
- 3 for 3906
- 4 for 7912

The selected ADC sample rate is saved to NVM. For example:

<the user enters “A0”>

```
response: Parameters saved to NVM bank 0
          Parameters saved to NVM bank 1
```

6.6.3 Set the IIR Filter Shift Value: “F” command

Type the character “F” and an index value from 0 to 8. The value is saved to NVM. For example:

<the user enters “F0”>

```
response: Parameters saved to NVM bank 0
          Parameters saved to NVM bank 1
```

6.6.4 Set the Calibration Value: “C” command

Type the character “C” and a value of “0” or “1”. The value is saved to NVM. For example:

<the user enters “C0”>

```
response: Parameters saved to NVM bank 0
          Parameters saved to NVM bank 1
```

6.6.5 View the Current Output Bit or Calibration Value in NVM: “R” command

Type the character “W” or “C” followed by “R”, to see the current value that is stored to NVM. For example:

<the user enters “CR”>

```
response: 0
          Parameters saved to NVM bank 0
          Parameters saved to NVM bank 1
```

6.6.6 Bias Command: “O” command

Type the character “O” command, and the FT output is reset to zero. There is not a response, when the command is entered.

7. Pseudocode Example

The following pseudocode provides a general idea of how to communicate with a sensor over a terminal interface from a user's custom software.

7.1 Assumed Functions For Pseudocode

To use the example pseudocode, the user must already have the following functions. These functions are dependent on the user's specific programming language and environment. The user may need to create functions that are different from the descriptions and examples in the following table.

Function	Description	Example (for most programming languages)
writeToSerial	writes the given string to the serial port and followed by a line terminator	"\r"
readToEndOfResponse	reads data from the serial port until it finds a new line character	"\n" followed by a prompt symbol such as ">"
readToNewLine	reads from the serial port until encounters a new line	no example available
splitWhiteSpace	returns a list of all fields in a given text string as an array with the first index starting at 0	no example available
parseFieldValue	returns the field value that is associated with a given field name in a structured response	similar to the output from the Set command (refer to Section 5.7—Set Command: "set")

7.2 Pseudocode to Read Tool Transform Distance Units

Sending "set ttdu" with no further arguments results in the sensor reporting the current value of the tool transform distance units (refer to [Table 5.3](#)), for example:

```
Field      Value
-----
ttdu      0
>
```

To write software that reads this value:

1. Send the command "set ttdu".

```
writeToSerial( "set ttdu" )
```

2. Read the response.

```
response = readToEndOfResponse()
```

3. Parse out the line that contains the field name and value (the line "ttdu 0" in the example output above).

- The specifics to implement the string parsing function depend on the user's programming environment and language.

```
myDistanceUnits = parseFieldValue(response, "ttdu")
```

7.3 Pseudocode to Read Tool Transform Distance Units

The command “C !FXYZTXYZ” instructs the sensor to begin streaming, with each sample include:

- the status code (the “!” specifier)
- the three force axes (“FXYZ”)
- the three torque axes (“TXYZ”)

Example record:

```
00000000  -0.007 N    0.005 N    0.060 N    0.0035 Nm
-0.0013 Nm  -0.0032 Nm
writeToSerial( "C !FXYZTXYZ")
```

read the data in a loop until user decides to quit.

```
while ( not done reading data )
```

```
    recordText = readToNewLine()
    splitRecord = splitWhiteSpace(recordText)
    statusValue = splitRecord[0]
```

Note that there are also spaces before the “N” and “Nm” unit markers. Skip over entries in the split record, for example: skipping fields 2, 4, and 6.

```
    forceX      = splitRecord[1]
    forceY      = splitRecord[3]
    forceZ      = splitRecord[5]
    torqueX     = splitRecord[7]
    torqueY     = splitRecord[9]
    torqueZ     = splitRecord[11]
```

Use the statusValue, force, and torque values in the user’s sensor system here.

8. Troubleshoot

This section includes answers to some issues that might arise when using RS422 with the ATI F/T Axia sensor. For more troubleshooting guidance, refer to the appropriate sensor manual in [Table 2.1](#). Answers to frequently asked questions are available on the ATI website: https://www.ati-ia.com/library/documents/FT_FAQ.pdf.

Note

Please read the manual before calling customer service. Before calling, have the following information available:

1. Serial number (e.g., FT01234)
2. Sensor model (e.g., Axia90-M50)
3. Calibration (e.g., US-15-50, SI-65-6, etc.)
4. Accurate and complete description of the question or problem
 - For the status code; refer to [Section 4.6—Status Code](#).
 - For the system's response to the status command; refer to [Section 5.12—Status Command: "status"](#).
5. Computer and software information (operating system, PC type, drivers, application software, and other relevant information about the application's configuration)

If possible, be near the F/T system when calling.

For additional troubleshooting information or to speak with a customer service representative, please contact ATI at:

ATI Industrial Automation

1031 Goodworth Drive
Apex, NC 27539 USA
www.ati-ia.com

Application Engineering

Tel: +1.919.772.0115, Extension 511
Fax: +1.919.772.8259
E-mail: ft_support@ati-ia.com
24/7 Support: +1 855 ATI-IA 00 (+1 855-284-4200)

8.1 LED Errors

Symptom: Status LED stays red after the (20) second power up phase.	Solution: Check the sensor cable connections. Verify the sensor cable is not damaged. There may be an internal error in the sensor. Check the status code, refer to Section 4.6—Status Code .
Symptom: Status LED is red for the first (20) seconds, after power up, and then turns green.	Solution: Normal.
Symptom: The RS422 Link/Activity LED is not green or flashing green.	Solution: Check the Ethernet cable connection.
Symptom: All LEDs are off.	Cause: The sensor is not powered on. Solution: Check the cables and the power source for the sensor.

8.2 Basic Guidance for Troubleshooting

Basic symptoms of inaccurate data and system errors are listed in the following section. For each symptom, causes and appropriate solutions are suggested.

Symptom: Noise — jumps in F/T readings greater than 0.05% of full-scale counts.

Cause: Noise can be caused by mechanical vibrations and electrical disturbances that are possibly from a poor ground. Electrical interference can also come from a high noise output device such as a motor.

Solution: Make sure that the DC supply voltage for the Axia sensor has little to no noise superimposed. Ground the sensor by connecting the cable's shield to ground. In most setups, 0 V is also connected to the ground. Connect the robot or other fixture to the same ground.

Verify that the sensor cables do not cross over other cables. Verify the sensor cables are not within close proximity to other equipment that could generate electrical noise.

Avoid sources of mechanical noise. If not possible, apply a filter to the data as described in [Section 4.5—Low-Pass Filter](#). For more information about Noise, refer to [Section 8.3—Reducing Noise](#).

Cause: Noise can also indicate component failure within the system.

Solution: Check the status code of the sensor; refer to [Section 4.6—Status Code](#).

Perform an accuracy check as described in the applicable ATI sensor manual in [Table 2.1](#) or in [Section 4.5: How do I evaluate the accuracy of health of the sensor?](#) in the Frequently Asked Questions (FAQ) ATI document located at: https://www.ati-ia.com/library/documents/FT_FAQ.pdf.

If the sensor fails the accuracy check, return the sensor to ATI for inspection. Contact ATI at rma-admin@ati-ia.com for a Returned Materials Authorization (RMA).

Symptom: Drift — when the F/T data continues to increase or decrease after a load is removed.

Cause: Some drift from a change in temperature is normal. Drift is observed more easily in the Z axis, compared to the X and Y axes.

Solution: After powering on the sensor, allow the sensor to warm-up for approximately thirty minutes or until the sensor is at a steady state with the air and other objects that contact the sensor. Use the bias command to shift the readings back to zero. Bias regularly.

Use an insulator between the sensor and any tooling or fixtures that are at a different temperature. Avoid creating a temperature gradient across the sensor. Shield the sensor from excessive air flow.

For more information about how to avoid drift from temperature change, refer to the following ATI document: <https://www.ati-ia.com/Library/Documents/DriftExplanation.pdf>.

Symptom: Hysteresis — when the sensor is loaded from a zeroed or biased state and then the load is removed, the sensor output does not immediately return to zero.	Cause: Mechanical coupling or internal failure can cause Hysteresis which is outside of the sensor’s specified and acceptable measurement uncertainty (error) range. Solution: Verify the sensor is properly installed, fasteners are tightened, and the customer tooling is securely installed; refer to the <i>Installation Section</i> in the applicable ATI F/T sensor manual in Table 2.1 . Use the bias command to shift the readings back to zero.
Symptom: Status Code ; Bit 1 - Supply voltage is out of range.	Cause: If the supply voltage is out of range, the bit is active which indicates a potential system fault or failure. Solution: Power cycle the system. Verify the power supply is within range per Section 9—Specifications .
Symptom: Status Code ; Bit 3 - Busy Bit	Cause: While the sensor is busy, the Busy Bit will be ON = 1. The sensor is busy applying a change such as an ADC rate change, filter, or an active calibration. Solution: After applying changes, wait until the Busy Bit is OFF = 0. Then read data or make any other changes.
Symptom: Status Code ; Bit 2, 27, or 30 - Out of Range	Cause: A load that is outside of the sensor’s calibrated measurement range has been applied to the sensor. Solution: Remove applied loads. If the errors do not go away, continue troubleshooting. Unmount the sensor. Improper mounting methods can induce high loads in the sensor. Switch to a larger calibration size, if the application requires loads outside the range of the smaller calibration size. After using the larger calibration size and without applying a load, if errors such as “Sensing Range Exceeded”, “Gage Out of Range”, or “Gage Broken” persist, the sensor is likely permanently damaged due to overload. Perform an accuracy check (refer to the applicable ATI sensor manual in Table 2.1) or refer to <i>Section 4.5: How do I evaluate the accuracy of health of the sensor?</i> in the Frequently Asked Questions (FAQ) ATI document located at: https://www.ati-ia.com/library/documents/FT_FAQ.pdf . If the sensor fails the accuracy check, return the sensor to ATI for inspection. Contact ATI at rma-admin@ati-ia.com for a Returned Materials Authorization (RMA).

<p>Symptom: The sensor is not responsive.</p>	<p>Cause: The sensor has insufficient power supply. Solution: Verify the power supply meets the requirements listed in Section 9—Specifications. Verify the cables are not damaged and are properly routed per the <i>Installation Section</i> in the applicable ATI manual in Table 2.1.</p> <p>Cause: The sensor has a hardware or software failure. Solution: Observe the Axia sensor LEDs; refer to Section 4.3—LED Normal Operation.</p>
<p>Symptom: The sensor is connected but not streaming data.</p>	<p>Cause: The user’s devices are not compatible with real time RS422 communication; refer to Section 3.3—Set-up of the RS422 Communication Interface. Solution: Verify devices are compatible; refer to Section 3.3—Set-up of the RS422 Communication Interface.</p> <p>Cause: The current baud rate of the user’s device does not match the current baud rate of the sensor. Solution: Verify the baud rate is properly set; refer to the “baud” field in Table 5.3 or Section 5.9—Baud Rate Command: “set baud”.</p> <p>Cause: The sensor has had a hardware or software failure. Solution: Observe the Axia sensor LEDs; refer to Section 4.3—LED Normal Operation.</p>
<p>Symptom: The actual data output rate of the sensor is less than expected.</p>	<p>Cause: The ADC and data rate may be set too high; refer to Section 4.4—Sample Rate. Solution: Reduce the ADC sample rate and the data rate; refer to the fields “adcRate” and “rdtRate” in Table 5.3.</p>
<p>Symptom: The values do not match expected values, for example: the F/T values are fluctuating but are higher than a known applied load.</p>	<p>Cause: The user may be viewing gage data instead of F/T data. Solution: Gage data is not a 1:1 correlation to F/T axis data. To view F/T data, refer to Section 5.3—Query Commands: “S” or “C”.</p> <p>Cause: It is normal to see an offset in the data, even when unloaded. Solution: Use the bias command to zero/tare the data.</p> <p>Cause: The sensor outputs data in counts. Counts must be divided by the Counts per Force (CpF) or Counts per Torque (CpT) in order to convert them to Calibration units (such as N and Nm). Solution: Verify if the user or user’s software is scaling the F/T values to convert into units. Use the CpF and CpT to convert the raw F/T values into units. For the CpF and CpT values, refer to the fields “cpF” and “cpt” in Table 5.3.</p> <p>Cause: If the raw F/T values are already converted into units and the values are high or nonsensical, verify that the sensor is not in one of these conditions: saturation, gage out of range, or F/T out of range. Check the status code of the sensor; refer to Section 4.6—Status Code. Solution: If the values exceed the ATI sensor’s calibration range per the ATI manual in Table 2.1, the reported values are incorrect. For more information, refer to Section 2.1: Measurement Range & Overload Limits in the Frequently Asked Questions (FAQ) ATI document.</p>

Symptom: The sensor does not report accurate F/T data.

Cause: The sensor may have been overloaded beyond its calibration limits. For calibration limits, refer to the applicable ATI manual listed in [Table 2.1](#).

Solution: Check the status code. Error bits related to overload are: 2, 27, and 30. See solution for [Symptom—Status Code; Bit 2, 27, or 30 - Out of Range](#).

Cause: The sensor system configuration is not set-up correctly in the user's software.

Solution: Verify the system is properly configured; refer to [Section 3—Installation](#) or contact ATI for assistance.

Cause: The user enabled tool transformation.

A tool transformation moves the origin and coordinates of the sensor data. If the tool transformation is incorrectly applied, the F/T data is skewed.

Solution: Check if a tool transformation is applied, and adjust it if needed. If all fields are 0, tool transformation is not applied; refer to the tool transformation fields in [Table 5.3](#).

For more information on the concept of tool transformation, refer to the applicable ATI manual in [Table 2.1](#).

Cause: The sensor is not properly installed, for example: improper fasteners are used, or the sensor is not mounted to a flat, stiff surface.

Solution: Verify the sensor is correctly installed; refer to the [Installation](#) and [Troubleshooting Sections](#) in the appropriate ATI F/T sensor manual listed in [Table 2.1](#).

Cause: It is normal to see an offset in the data, even when unloaded.

Solution: Use the bias command to zero/tare the data.

Cause: Mechanical coupling — an external object such as customer tooling or utilities is contacting a sensor's surface between the mounting side and tool side.

Solution: Remove any debris between the tool side and interface plate. Use proper cable management for cables and hoses; do not connect them tightly between the mounting and tool side of the sensor.

Anything that contacts surfaces such as the through hole in the sensor or cover plates on either side of the sensor induces loading or movement that could result in inaccurate F/T data.

Symptom: The initial F/T values are non-zero and no load is applied.

Solution: Normal. Bias the sensor to bring all the F/T values back to zero.

8.3 Reducing Noise

8.3.1 Mechanical Vibration

In many cases, perceived noise is actually a real fluctuation of force and/or torque, caused by vibrations in the tooling or the robot arm. The Axia sensor offers digital low-pass filters that can dampen frequencies above a certain threshold. If digital low-pass filters are insufficient, a digital filter may be added to the application software.

8.3.2 Electrical Interference

To reduce the effects of electrical noise on the sensor, do the following:

- If interference by motors or other noise-generating equipment is observed, check the sensor's ground connections.
- If sufficient grounding is not possible or does not reduce noise, consider using the sensor's digital low-pass filters.
- Verify the power supply is Class 1 which has an earth ground connection.

9. Specifications

9.1 Electrical Specifications

Power Source	Voltage			Power Consumption
	Minimum	Nominal	Maximum	Maximum
DC Power	12 V	24 V	30 V	1.5 W

Notes:

1. The power supply input is reverse polarity protected. If the power and ground to the power supply inputs are plugged in reverse, then the reverse polarity protection stops the incorrectly wired supply input from damaging or powering on the sensor.

9.2 Cable Specifications

9.2.1 P/N 9105-C-ZC27-ZC28

Table 9.2—9105-C-ZC27-ZC28 M8, 8-pin, Female Connector to M12 A-Coded, 8-pin, Male Connector	
Parameter	Value
Voltage Rating	> 30 V
Current Rating	> 0.25 A
IP Rating	IP67 ¹
Operating Temperature Range (Min-Max)	-5°C to 70°C
Note:	
1. The cable is rated IP67 when the cable is connected at both ends. The IP rating of the cable may exceed the IP rating of the sensor, but the sensor IP rating remains the value listed in the sensor manual's specifications. For the applicable sensor manual, refer to Table 2.1 .	

9.2.2 P/N 9105-C-ZC28-ZC28

Table 9.3—9105-C-ZC28-ZC28 M12, 8-pin, Female Connector to M12, 8-pin, Male Connector	
Parameter	Value
Voltage Rating	60 V
Current Rating	> 0.25 A
IP Rating	IP67 ¹
Operating Temperature Range (Min-Max)	-5°C to 70°C
Note:	
1. The cable is rated IP67 when the cable is connected at both ends. The IP rating of the cable may exceed the IP rating of the sensor, but the sensor IP rating remains the value listed in the sensor manual's specifications. For the applicable sensor manual, refer to Table 2.1 .	

9.2.3 P/N 9105-C-ZC28-MS-ZC35-4

Table 9.4—9105-C-ZC28-MS-ZC35-4 M12, 8-pin, Female Connector Split to M12, 5-pin, and DB9 Connectors	
Parameter	Value
Voltage Rating	> 30 V
Current Rating	> 0.25 A
IP Rating	IP67 ¹
Operating Temperature Range (Min-Max)	-5°C to 70°C
Note:	
1. The cable is rated IP67 on the M12 connectors when the cable is connected at both ends and the DB9 leg is otherwise protected from the elements. The DB9 leg of this cable is not IP rated and should not be exposed to dirty or wet environments without secondary protection. The IP rating of the cable may exceed the IP rating of the sensor, but the sensor IP rating remains the value listed in the sensor manual's specifications. For the applicable sensor manual, refer to Table 2.1 .	

10. Terms and Conditions of Sale

The following Terms and Conditions are a supplement to and include a portion of ATI's Standard Terms and Conditions, which are on file at ATI and available upon request.

ATI warrants to Purchaser that force torque sensor products purchased hereunder will be free from defects in material and workmanship under normal use for a period of one (1) year from the date of shipment. The warranty period for repairs made under a RMA shall be for the duration of the original warranty, or ninety (90) days from the date of repaired product shipment, whichever is longer. ATI will have no liability under this warranty unless: (a) ATI is given written notice of the claimed defect and a description thereof with thirty (30) days after Purchaser discovers the defect and in any event, not later than the last day of the warranty period and (b) the defective item is received by ATI not later than (10) days after the last day of the warranty period. ATI's entire liability and Purchaser's sole remedy under this warranty is limited to repair or replacement, at ATI's election, of the defective part or item or, at ATI's election, refund of the price paid for the item. The foregoing warranty does not apply to any defect or failure resulting from improper installation, operation, maintenance, or repair by anyone other than ATI.

ATI will in no event be liable for incidental, consequential, or special damages of any kind, even if ATI has been advised of the possibility of such damages. ATI's aggregate liability will in no event exceed the amount paid by the purchaser for the item which is the subject of claim or dispute. ATI will have no liability of any kind for failure of any equipment or other items not supplied by ATI.

No action against ATI, regardless of form, arising out of or in any way connected with products or services supplied hereunder, may be brought more than one year after the cause of action accrued.

No representation or agreement varying or extending the warranty and limitation of remedy provisions contained herein is authorized by ATI, and may not be relied upon as having been authorized by ATI, unless in writing and signed by an executive officer of ATI.

Unless otherwise agreed in writing by ATI, all designs, drawings, data, inventions, software, and other technology made or developed by ATI in the course of providing products and services hereunder, and all rights therein under any patent, copyright, or other law protecting intellectual property, shall be and remain ATI's property. The sale of products or services hereunder does not convey any expressed or implied license under any patent, copyright, or other intellectual property right owned or controlled by ATI, whether relating to the products sold or any other matter, except for the license expressly granted below.

In the course of supplying products and services hereunder, ATI may provide or disclose to Purchaser confidential and proprietary information of ATI relating to the design, operation, or other aspects of ATI's products. As between ATI and Purchaser, ownership of such information, including without limitation any computer software provided to Purchaser by ATI, shall remain in ATI and such information is licensed to Purchaser only for Purchaser's use in operating the products supplied by ATI hereunder in Purchaser's internal business operations.

Without ATI's prior written permission, Purchaser will not use such information for any other purpose or provide or otherwise make such information available to any third party. Purchaser agrees to take all reasonable precautions to prevent any unauthorized use or disclosure of such information.

Purchaser will not be liable hereunder with respect to disclosure or use of information which: (a) is in the public domain when received from ATI, (b) is thereafter published or otherwise enters the public domain through no fault of Purchaser, (c) is in Purchaser's possession prior to receipt from ATI, (d) is lawfully obtained by Purchaser from a third party entitled to disclose it, or (f) is required to be disclosed by judicial order or other governmental authority, provided that, with respect to such to maintain the confidentiality of such information.

D. Custom Application

This modular manual section does not apply to this sensor system.

Please contact an ATI representative for assistance, if needed:

Sale, Service and Information about ATI products:

ATI Industrial Automation

1031 Goodworth Drive

Apex, NC 27539 USA

www.ati-ia.com

Tel: +1.919.772.0115

Fax: +1.919.772.8259

Application Engineering

Tel: +1.919.772.0115, Extension 511

Fax: +1.919.772.8259

E-mail: ft.support@novanta.com

24/7 Support: +1 855 ATI-IA 00 (+1 855-284-4200)