



## **ATI F/T Sensor URcaps Software Installation and Setup Manual for URe Robots**



**Document #: 9610-05-1040**

## Foreword

Information contained in this document is the property of ATI Industrial Automation, Inc. and shall not be reproduced in whole or in part without prior written approval of ATI Industrial Automation, Inc. The information herein is subject to change without notice and should not be construed as a commitment on ATI Industrial Automation, Inc. This manual is periodically revised to reflect and incorporate changes made to the F/T system.

ATI Industrial Automation, Inc. assumes no responsibility for any errors or omissions in this document.

Copyright © (2021) by ATI Industrial Automation, Inc., Apex, North Carolina USA. All Rights Reserved. Published in the USA.

In consideration that ATI Industrial Automation, Inc. (ATI) products are intended for use with robotic and/or automated machines, ATI does not recommend the use of its products for applications wherein failure or malfunction of an ATI component or system threatens life or makes injury probable. Anyone who uses or incorporates ATI components within any potentially life threatening system must obtain ATI's prior consent based upon assurance to ATI that a malfunction of ATI's component does not pose direct or indirect threat of injury or death, and (even if such consent is given) shall indemnify ATI from any claim, loss, liability, and related expenses arising from any injury or death resulting from use of ATI components.

*All trademarks belong to their respective owners.*

*Windows is registered trademarks of Microsoft Corporation.*

*UR is a trademark of Universal Robots.*

### Note

Please read the manual before calling customer service and have the following information available:

1. Serial number (e.g., FT01234)
2. Sensor model (e.g., Axia)
3. Calibration (e.g., US-15-50, SI-65-6, etc.)
4. Accurate and complete description of the question or problem
5. Computer and software information (operating system, PC type, drivers, application software, and other relevant information about the application's configuration)

Be near the F/T system when calling (if possible).

Please contact an ATI representative for assistance, if needed:

Sale, Service, and Information about ATI products:

#### **ATI Industrial Automation**

1031 Goodworth Drive

Apex, NC 27539 USA

[www.ati-ia.com](http://www.ati-ia.com)

Tel: +1.919.772.0115

Fax: +1.919.772.8259

Technical support:

#### **Application Engineering**

Tel: +1.919.772.0115, Extension 511

Fax: +1.919.772.8259

E-mail: [ft\\_support@ati-ia.com](mailto:ft_support@ati-ia.com)

## Table of Contents

<b>Foreword</b> .....	<b>2</b>
<b>Glossary</b> .....	<b>4</b>
<b>1. Safety</b> .....	<b>6</b>
1.1 Explanation of Notifications .....	6
1.2 General Safety Guidelines .....	6
1.3 Safety Precautions .....	6
<b>2. Overview</b> .....	<b>7</b>
2.1 ATI F/T Kits for Ethernet Axia and Serial Axia .....	8
2.1.1 Unpacking the ATI F/T Kit .....	10
<b>3. Installation</b> .....	<b>10</b>
3.1 Installing an ATI F/T Ethernet Sensor to the URe Robot .....	10
3.2 Installing an ATI F/T Serial Axia Sensor to the URe Robot .....	10
3.3 Removing the ATI F/T Serial Axia Sensor from the Robot .....	13
<b>4. Setup of the ATI F/T URcaps Software</b> .....	<b>14</b>
4.1 Downloading ATI F/T URcaps Software from the ATI Website .....	14
4.2 Loading the ATI F/T URcaps Software on the Teach Pendant .....	14
4.2.1 Remove the ATI F/T URcaps Software from the Teach Pendant .....	18
4.3 Set-up an ATI F/T Ethernet Sensor on the Teach Pendant .....	18
4.4 Set-up an ATI F/T Serial Sensor on the Teach Pendant .....	22
4.5 Determining the Tooling Mass and Offset .....	27
4.5.1 Tooling Mass and Offset for a Sensor and Mounting Interface Plate .....	27
4.5.2 Tooling Mass and Offset for Sensor with Mounting and Tool Interface Plates .....	30
<b>5. Troubleshooting</b> .....	<b>33</b>
5.1 Errors with the ATI URcap Software .....	33
<b>6. Terms and Conditions of Sale</b> .....	<b>34</b>

## Glossary

Term	Definition
Acceptable Status Condition	A user set state during which the ATI URcap software ignores certain status bits from the ATI F/T sensor so that the UR robot can continue operation.
Algorithm	A process or set of rules the robot uses to provide force feedback to control the robot motion.
ATI Ethernet Axia Sensor or ATI NET F/T Sensor	An ATI F/T sensor that uses Ethernet protocol.
“ATI FT Daemon failed” Error	An error that occurs if the ATI URcap’s Python™ script is unable to run correctly. The Python™ script/Daemon runs in the background on the UR controller’s Linux computer.
ATI NET F/T Sensor	An ATI Ethernet F/T sensor that is not an Axia80.
ATI Serial Axia Sensor	An ATI F/T Axia sensor that uses RS485 protocol.
ATI F/T URcap Software	An ATI software program that enables the UR robot to use data from an ATI F/T sensor for force feedback control.
Center of Gravity (CG)	The point of a mass around which the resultant torque from gravity forces is zero.
Daemon	A python™ program that runs continuously on the UR controller’s Linux computer. It handles periodic service requests that the ATI URcap software expects to receive. The daemon program can forward these requests to other programs or processes as appropriate.
Demo Program	A downloadable program that demonstrates the capabilities of the ATI URcap software and ATI F/T sensor.
DoF	Degrees of Freedom (refer to the following definition: Six Degrees of Freedom)
Ethernet	An IEEE standard for local network technology.
Force	The push or pull exerted on an object. Mathematically, force is expressed as: Force = mass x acceleration
F/T	Force/Torque
F/T Sensor	The device that converts sense loads from force and torque into an electrical signal.
Interface Plate	A separate plate that attaches the sensor to another surface. Interface plates are often used if the bolt pattern on the MAP or TAP doesn’t match the bolt pattern on the robot arm or customer tooling. The interface plate has (2) bolt patterns on either side of the plate. One side is for the MAP or TAP. The other side is for the robot arm or customer tooling.
Hamburger Menu   	A drop-down menu button on the URe Teach Pendant screen that includes the following: help, about, and settings.
Mounting Adapter Plate   MAP	The surface of the sensor that attaches to a fixed surface like an interface plate or robot arm.
Plug-in Technology	A customized program that when downloaded and installed onto a host device adds a specific feature to an existing computer program.
P/N	Part Number
Polyscope	UR software on the teach pendant.
Six Degrees of Freedom	Fx, Fy, Fz, Tx, Ty, and Tz

Term	Definition
Sense loads	The ATI F/T sensor detects sense loads that are a cumulation of forces and torques acted upon the customer tooling.
Status Bit	A unit of computer data sent from the ATI F/T sensor.
Tool Adapter Plate   TAP	The surface of the sensor that attaches to a fixed surface like an interface plate or the customer tooling.
TCP	Tool Center Point
Teach Pendant	A handheld device or control box for programming the motions of a robot.
Torque	The measurement of force exerted on an object causing it to rotate. Mathematically, force is expressed as: $Torque = Force \times Moment\ Arm\ Distance$
URe robot	A collaborative robot manufactured and distributed by the company, Universal Robots (UR). URe denotes a robot from the UR E-series product line.
URe Kit	A packaged option that includes the ATI Serial Axia F/T sensor, interface plates, mounting hardware, cable to the URe tool port, and downloadable ATI URcap software. This kit can only be used with a URe robot.
UR Kit	A packaged option that includes an ATI Ethernet Axia F/T sensor, interface plate(s), cables, mounting hardware, and downloadable ATI URcap software. This kit can be used with a UR or URe robot.
USB Drive	A USB (universal serial bus) drive is a device that data such as the downloaded ATI URcap software and can be attached to a host device with plug-in technology. Sometimes a USB drive is called a USB stick or USB disk.

## 1. Safety

The safety section describes general safety guidelines to be followed with this product, explanations of the notifications found in this manual, and safety precautions that apply to the product. Product specific notifications are imbedded within the sections of this manual (where they apply).

### 1.1 Explanation of Notifications

These notifications are used in all of ATI manuals and are not specific to this product. The user should heed all notifications from the robot manufacturer and/or the manufacturers of other components used in the installation.



**DANGER:** Notification of information or instructions that if not followed will result in death or serious injury. The notification provides information about the nature of the hazardous situation, the consequences of not avoiding the hazard, and the method for avoiding the situation.



**WARNING:** Notification of information or instructions that if not followed could result in death or serious injury. The notification provides information about the nature of the hazardous situation, the consequences of not avoiding the hazard, and the method for avoiding the situation.



**CAUTION:** Notification of information or instructions that if not followed could result in moderate injury or will cause damage to equipment. The notification provides information about the nature of the hazardous situation, the consequences of not avoiding the hazard, and the method for avoiding the situation.

**NOTICE:** Notification of specific information or instructions about maintaining, operating, installing, or setting up the product that if not followed could result in damage to equipment. The notification can emphasize, but is not limited to: specific grease types, best operating practices, and maintenance tips.

### 1.2 General Safety Guidelines

The customer should verify that the sensor selected is rated for maximum loads and torques expected during operation. Because static forces are less than the dynamic forces from the acceleration or deceleration of the robot, be aware of the dynamic loads caused by the robot.

### 1.3 Safety Precautions



**WARNING:** Performing maintenance or repair on the sensor when circuits (for example: power, water, and air) are energized could result in death or serious injury. Discharge and verify all energized circuits are de-energized in accordance with the customer's safety practices and policies.



**CAUTION:** Ensure the cable shield is properly grounded. Improper shielding on the cables can cause communication errors and an inoperative ATI F/T sensor.

## 2. Overview

This manual provides an overview of the ATI F/T Axia kits compatible with the URe robot, a procedure for installation of the ATI F/T URe kit to a robot, and procedures to set-up the ATI URcaps software. For programming the ATI URcaps software and demo programs, refer to the [9610-05-1041](#) manual. The ATI URcaps software enables the customer to use an URe robot with either an ATI Ethernet or Serial Force/Torque (F/T) sensor.

F/T sensors convert sensed loads from forces and torques into electrical signals. The F/T sensor provides data to the robot. This data is the six Degrees of Freedom (DoF):  $F_x \setminus F_y \setminus F_z \setminus T_x \setminus T_y \setminus T_z$ . URe robots have algorithms to use force feedback to control robot motion. By using plug-in technology, the ATI URcaps software allows a user to input data from an ATI sensor into UR algorithms.

Communicating with the sensor and URe robot requires a knowledge of Ethernet / RS485 protocol, and how to operate the URe teach pendant interface *Polyscope*. For more information about UR products, refer to <https://www.universal-robots.com/support/>. For more information on the ATI F/T sensors, refer to the following table:

Table 2.1—ATI F/T Sensor Manuals	
ATI F/T Sensor	ATI Manual P/N
Serial Axia	<a href="#">9610-05-Serial Axia</a>
Ethernet Axia	<a href="#">9610-05-Ethernet Axia</a>
All Other Ethernet Sensors	<a href="#">9620-05-NET FT</a> and <a href="#">9620-05-Transducer Section</a>

**NOTICE:** The [9105-URe-Axia80 Kit Drawing](#) (ATI P/N 9230-05-1546) is available on the ATI F/T Literature website: [https://www.ati-ia.com/products/ft/ft\\_literature.aspx](https://www.ati-ia.com/products/ft/ft_literature.aspx).

Figure 2.1—Overview

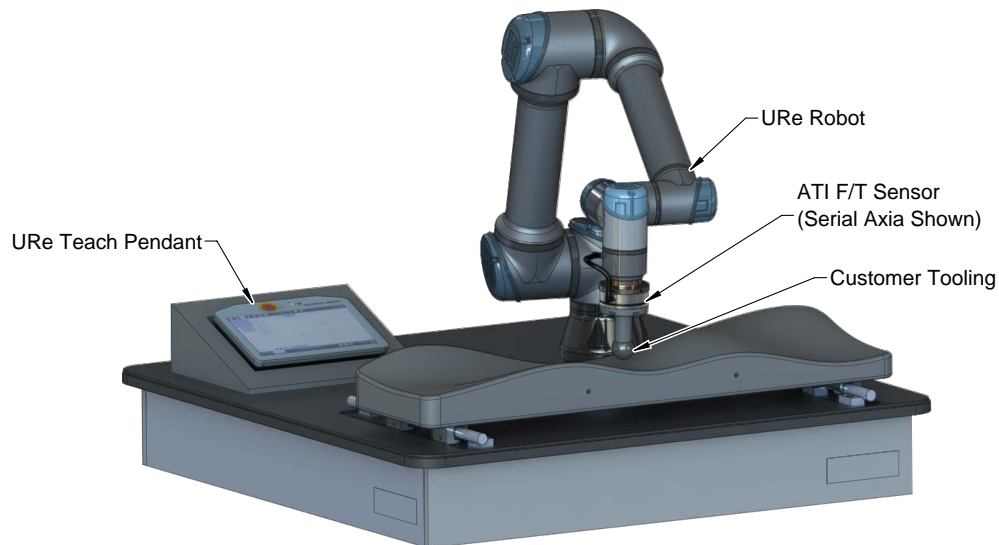

## 2.1 ATI F/T Kits for Ethernet Axia and Serial Axia

ATI provides the following kit options:

Item	P/N	ATI Kit P/N		
		9105-COB- URE- AXIA80-01 (Figure 2.2)	9105-COB- UR- AXIA80-02 (Figure 2.3)	9105-COB- UR- AXIA80-02 (Figure 2.3)
Ethernet Axia F/T Sensor	9105-NET- AXIA80-M20 <sup>1</sup>		✓	✓
Serial Axia F/T Sensor	9105-RS485- AXIA80-M20	✓		
Mounting Interface Plate Assembly	9105-IP-2126	✓	✓	✓
Tool Interface Plate Assembly	9105-IP-2191	✓	✓	
Ethernet and Power Cable Kit	9105-CKIT- ZC22-ZC28-4		✓	✓
Split Power and RJ45 Ethernet Cable: 8-pin M12 connector that splits to a RJ45 Ethernet connection and an unterminated end for power	9105-C-ZC28- U-RJ45S-4		✓	✓
Serial Cable: 6-pin sensor connector and 8-pin robot connector	9105-C-ZC44- ZC45-0.15	✓		
Note:				
1. Part number used to be 9105-NET-AXIA80-M20-ZC22.				

The mounting interface plate assembly (ATI P/N 9105-IP-2126) includes the following:

- (1) interface plate (ATI P/N 3700-05-2126) that mounts the MAP to the robot arm
- (6) M5-0.8 x 12 mm socket head cap screws (ATI P/N 3500-1064012-15) for mounting the sensor to the interface plate
- (4) M6-1 x 18 mm socket head cap screws (ATI P/N 3500-1066018-15) for mounting the interface plate to the robot arm
- (2) M4 x 12 mm dowel pins for aligning the sensor to the interface plate
- (1) M6 x 12 mm dowel pin for aligning the interface plate to the robot
- (1) clamp loop for routing the 9105-C-ZC22-ZC28-4 cable
- (1) 4 mm low profile hex key (ATI P/N 3810-05-2182) for the M5 socket head cap screws

The tool interface plate assembly (ATI P/N 9105-IP-2191) includes the following:

- (1) interface plate (ATI P/N 3700-05-2191) that mounts the TAP to the customer tooling
- (6) M5-0.8 x 12 mm socket head cap screws (ATI P/N 3500-1064012-15) for mounting the interface plater to the sensor
- (1) M3 x 16 mm dowel pin for aligning the sensor to the interface plate
- (1) M4 x 16 mm dowel pin for aligning the sensor to the interface plate

The Ethernet and Power Cable Kit (ATI P/N 9105-CKIT-ZC22-ZC28-4) includes the following:

- (1) Ethernet and power cable (ATI P/N 9105-C-ZC22-ZC28-4) with a 6-pin sensor connector and an 8-pin M12 connector
- (1) L-bracket kit (ATI P/N 9005-05-1076) for cable routing



- (1) P-clip kit and (6) cable straps for cable routing (ATI P/N 9005-05-1077)

**Figure 2.2—URe Kit, P/N 9105-COB-URE-AXIA80-01**

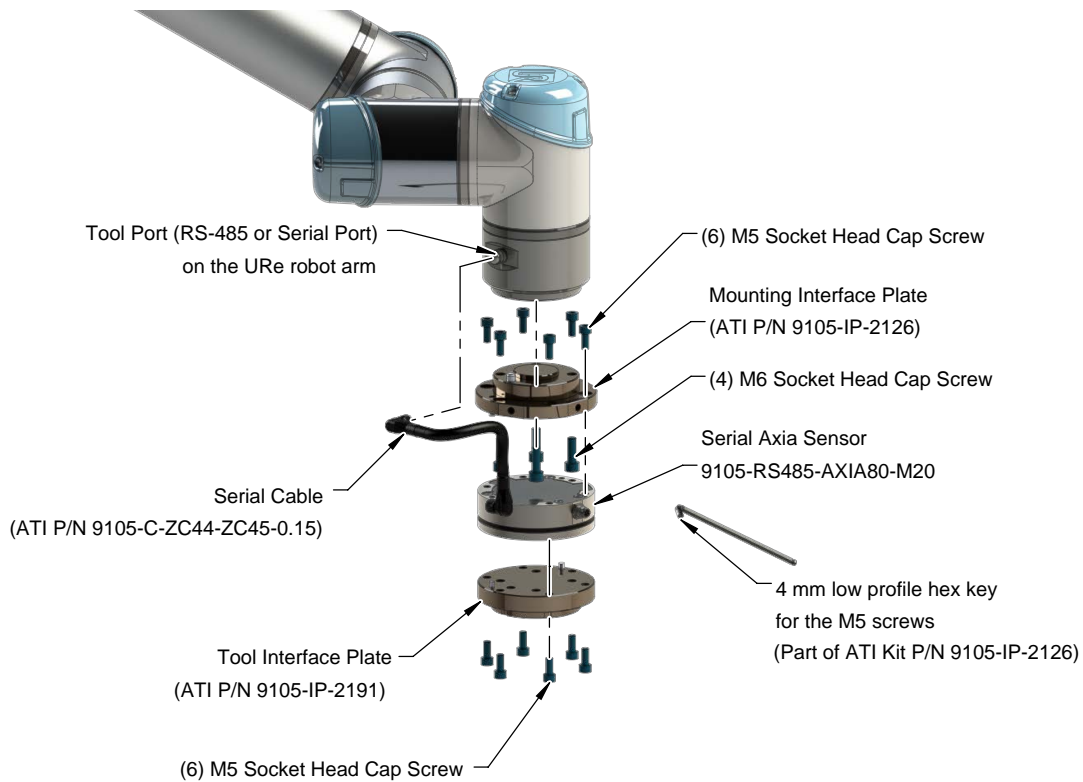

**Figure 2.3—UR Kit, P/N 9105-COB-UR-AXIA80-01 and 9105-COB-UR-AXIA80-02**

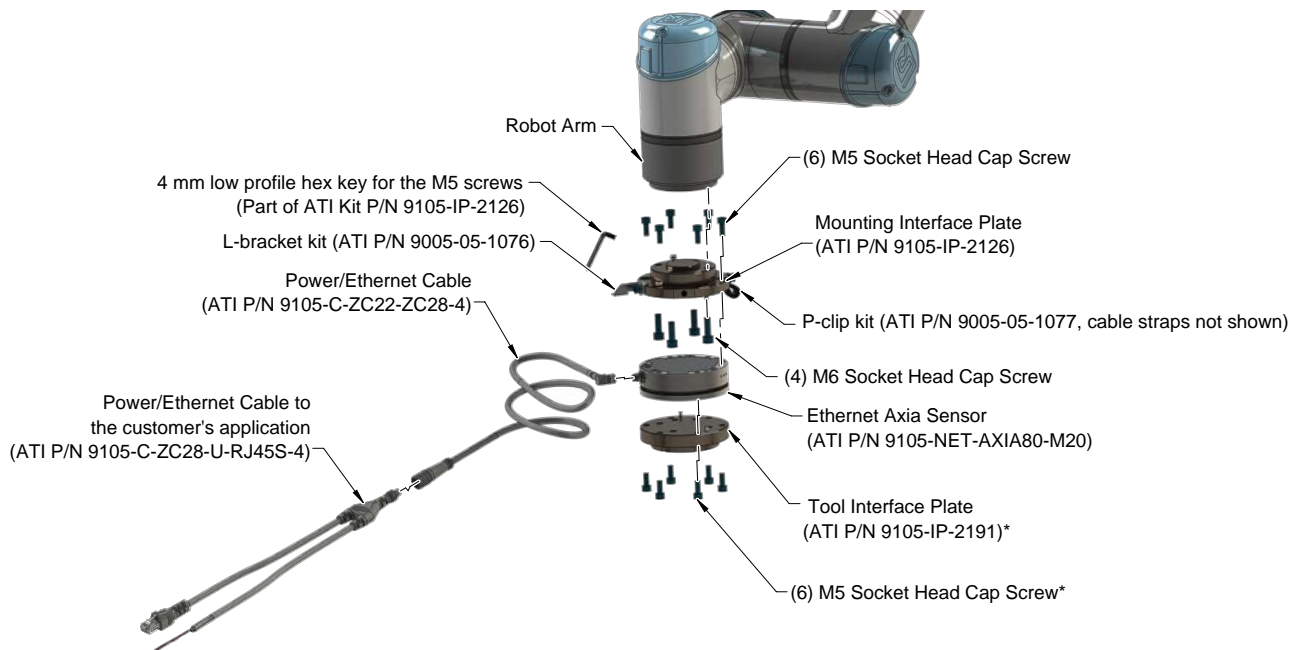

\*Available with the 9105-COB-UR-AXIA80-01 Kit

### 2.1.1 Unpacking the ATI F/T Kit

Upon receipt of a kit, complete the following:

- Check the shipping container and components for damage that may have occurred during shipping. Report damage to ATI Industrial Automation (for contact information, refer to [page 2](#)).
- Verify the components from the packing list are included in the kit.
- For standard components included in the kit, refer to [Section 2.1—ATI F/T Kits for Ethernet Axia and Serial Axia](#).

## 3. Installation



**WARNING:** Performing maintenance or repair on the sensor when circuits (for example: power, water, and air) are energized could result in death or serious injury. Discharge and verify all energized circuits are de-energized in accordance with the customer's safety practices and policies.

### 3.1 Installing an ATI F/T Ethernet Sensor to the URe Robot

Refer to the applicable manual in [Table 2.1](#).

### 3.2 Installing an ATI F/T Serial Axia Sensor to the URe Robot

For the sensor's technical specifications and accuracy check procedure, refer to the [9610-05-Serial Axia](#) manual.

For a visual reference of the following procedure, refer to [Figure 3.1](#).

**Parts required:** Refer to [Section 2.1—ATI F/T Kits for Ethernet Axia and Serial Axia](#)

**Tools required:** 4 mm low profile hex key (part of ATI kit P/N 9105-IP-2126) and 5 mm hex key

**Supplies required:** Clean rag, Loctite® 242 (if applicable)

1. Clean the mounting surfaces.

**NOTICE:** With all fasteners used to mount the sensor and interface plates, consider the following points:

- Screws must have a minimum thread engagement length of 4.5 mm and a maximum thread engagement less than the threaded depth that is listed in the customer drawing in the [9610-05-Serial Axia](#) manual.
- Unless otherwise specified, apply Loctite 242 to the socket head cap screws (class 12.9) so that the fasteners secure the sensor to the mounting plate.

2. Attach the mounting interface plate to the robot arm with the mounting fasteners.
  - a. Using a 5 mm hex key, secure the interface plate to the robot arm with (4) M6 socket head cap screws (class 12.9). Tighten to 89 in-lbs (10 Nm).
3. Attach the sensor to the mounting interface plate.
  - a. Using a 4 mm low profile hex key, secure the sensor to the interface plate with (6) M5 socket head cap screws (class 12.9). Tighten to 52 in-lbs (5.88 Nm).
4. Attach the tool interface plate to the sensor.
  - a. Using a 4 mm hex key, secure the tool interface plate to the sensor with (6) M5 socket head cap screws (class 12.9). Tighten to 52 in-lbs (5.88 Nm).

**NOTICE:** The tool must not touch any other part of the sensor except the tool side; otherwise, the sensor will not properly detect loads.

5. Install the customer tooling.

**Figure 3.1—Installation of the Serial Sensor Kit to the Robot**

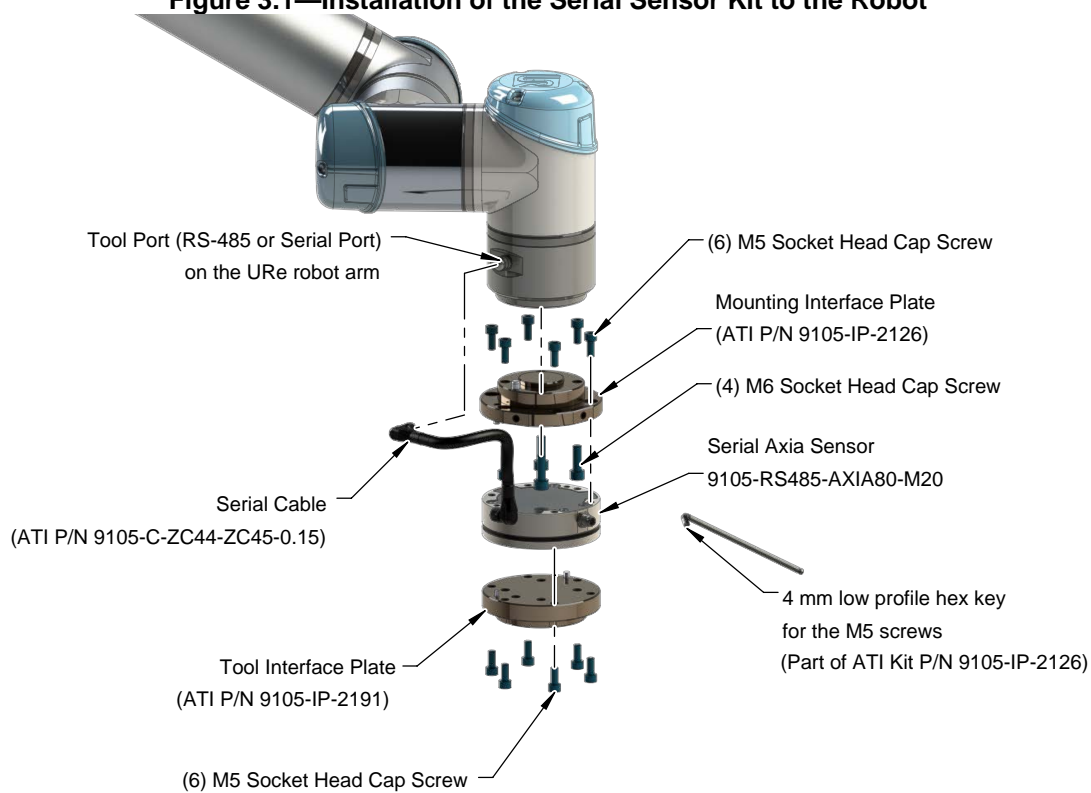

**CAUTION:** Ensure the cable shield is properly grounded. Improper shielding on the cables can cause communication errors and an inoperative Serial Axia sensor.



**CAUTION:** Do not apply excessive force to the sensor and cable connector during installation, or damage will occur to the connectors. Align the keyway on the sensor and cable connector during installation to avoid applying excessive force to the connectors.

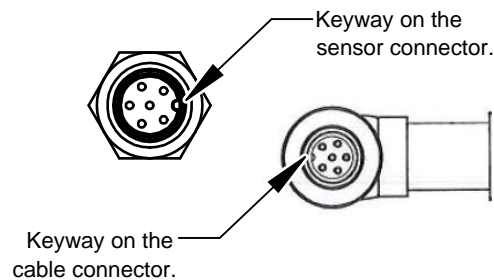

**NOTICE:** After connecting the cable to the sensor and applying power, the customer can refer to the [9610-05-Serial Axia](#) manual for monitoring the sensor status by the LEDs.

**Table 3.1—Power Supply**

Power Source	Voltage			Maximum Power Consumption
	Minimum	Nominal	Maximum	
DC Power	12 V	24 V	30 V	1.5 W

Notes:

1. The power supply input is reverse polarity protected. If the power and ground to the power supply inputs are plugged in reverse, then the reverse polarity protection stops the incorrectly wired supply input from damaging or powering on the sensor.
2. Install the serial cable. For the pin connections, refer to the following tables:
  - a. Connect the 6-pin female M8 connector on the cable to the sensor’s M8 connector. Tighten to 4.43 in-lbs (0.5 Nm).

**Table 3.2—Pin Assignment for the 6-pin M8 Male Serial Axia Sensor Connector**

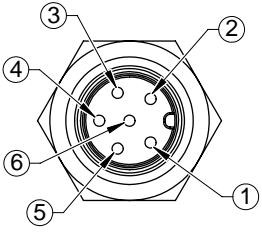
Connector Schematic	Pin Number	Signal
	1	RS485+
	2	RS485-
	3	CLK_SYNC
	4	Ground (for CLK_SYNC)
	5	V +
	6	V -

- b. Connect the 8-pin female M8 connector on the cable to the RS-485 connector on the robot arm. Tighten to 4.43 in-lbs (0.5 Nm).

**Table 3.3—Pin Assignment for the 8-pin M8 Female Connector**

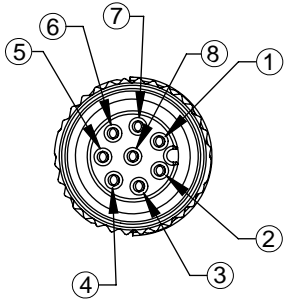
Connector Schematic	Pin Number	Signal
	1	RS485+
	2	RS485-
	3	CLK_SYNC
	4	Ground (for CLK_SYNC)
	5	V +
	6	V -
	7	-
	8	-

3. Complete an accuracy check on the sensor (refer to the [9610-05-Serial Axia](#) manual).
4. Safely start normal operation.

### 3.3 Removing the ATI F/T Serial Axia Sensor from the Robot

**Tools required:** 4 mm low profile hex key (part of ATI kit P/N 9105-IP-2126)

1. Turn off all energized circuits, for example: electrical.
2. Remove the 6-pin female M8 cable from the sensor's connection.
3. Use a 4 mm low profile hex key to remove the (6) M5 socket head cap screws that secure the tool interface plate to the sensor.
4. While supporting the sensor, use a 4 mm low profile hex key to remove the (6) M5 socket head cap screws that secure the sensor to the mounting interface plate.
5. Remove the sensor.

**Figure 3.2—Remove the Sensor from the Robot**

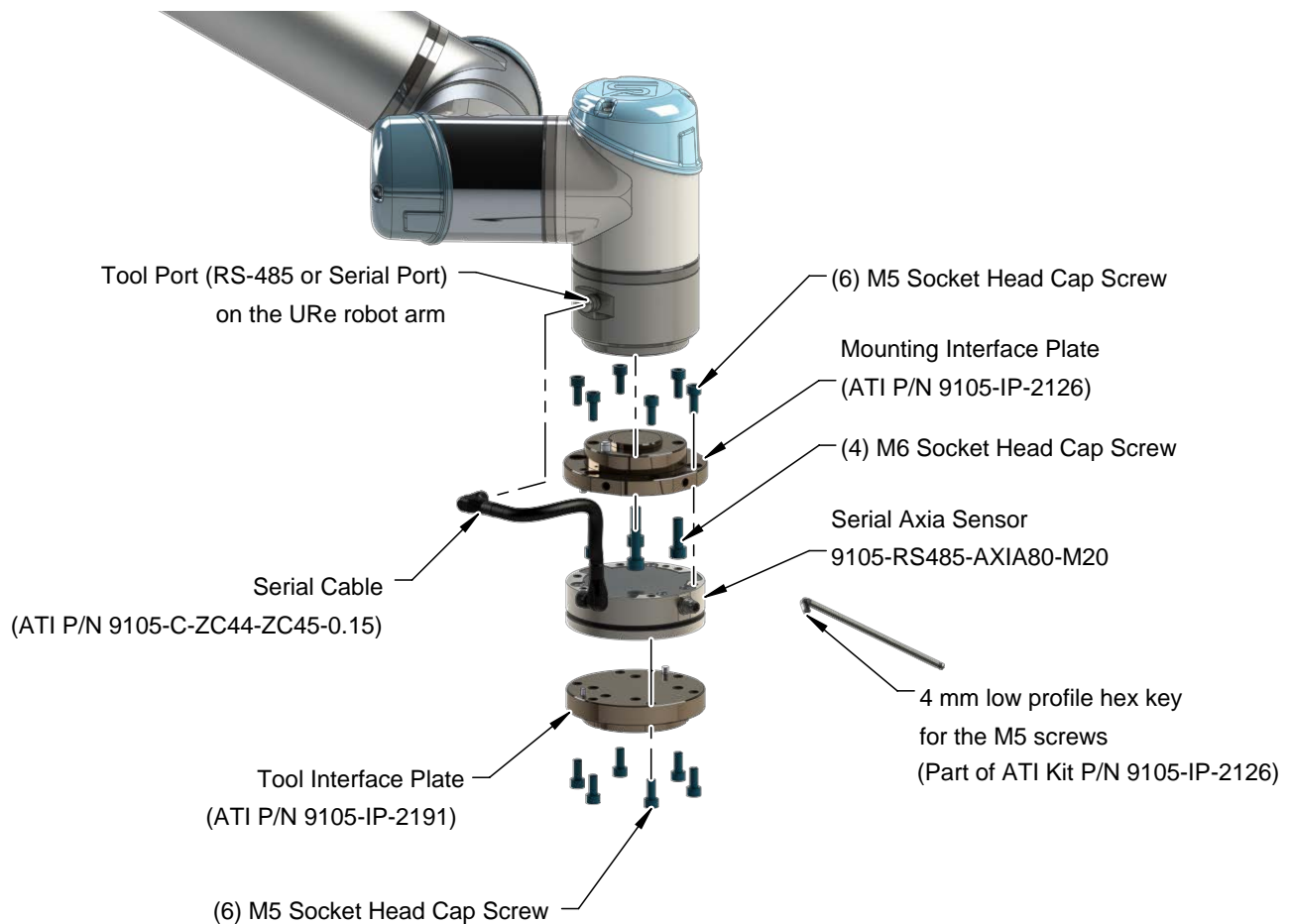

## 4. Setup of the ATI F/T URCaps Software

To use an ATI F/T sensor with a URe robot, the user must first install and set-up the ATI URCaps software to the robot. For more detailed information on the URe teach pendant software functionality such as safety, operation, programming, and URe nomenclature, refer to the [UR Polyscope Manual, Version 5.1.0](#). For consistency, URe nomenclature is used in the following procedures.

### 4.1 Downloading ATI F/T URCaps Software from the ATI Website

**Supplies required:** Computer with web browser and internet access, USB drive

1. Using a web browser, navigate to [http://www.ati-ia.com/Products/ft/software/axia\\_software.aspx](http://www.ati-ia.com/Products/ft/software/axia_software.aspx).
2. Download the ATI F/T URCap software package **F/T Universal Robots Software**.
3. Save the file to a local drive. (right click on the folder, and select **Export** or **Export All**)
4. Unzip the file.
5. Save the **ATI\_FT-\*.urcap** file to a portable USB drive.
6. (Optional) save the **ATI Demo Program.urp** and **ATI Simple Demo Program.urp** to a portable USB drive for transfer to the teach pendant.
7. Eject the USB drive.

### 4.2 Loading the ATI F/T URCaps Software on the Teach Pendant

To load the ATI F/T URCaps software from the USB drive to the teach pendant, refer to the following steps:

1. Insert a USB drive that contains the ATI F/T URCaps package into the USB port on the top of the teach pendant.

**Figure 4.1—Insert USB Drive into USB Port on the Teach Pendant**



2. Turn power on the teach pendant. The **Getting Started** screen appears on the teach pendant.
3. On the upper right hand corner of the screen, select the **Hamburger** menu button.

**Figure 4.2—Getting Started**

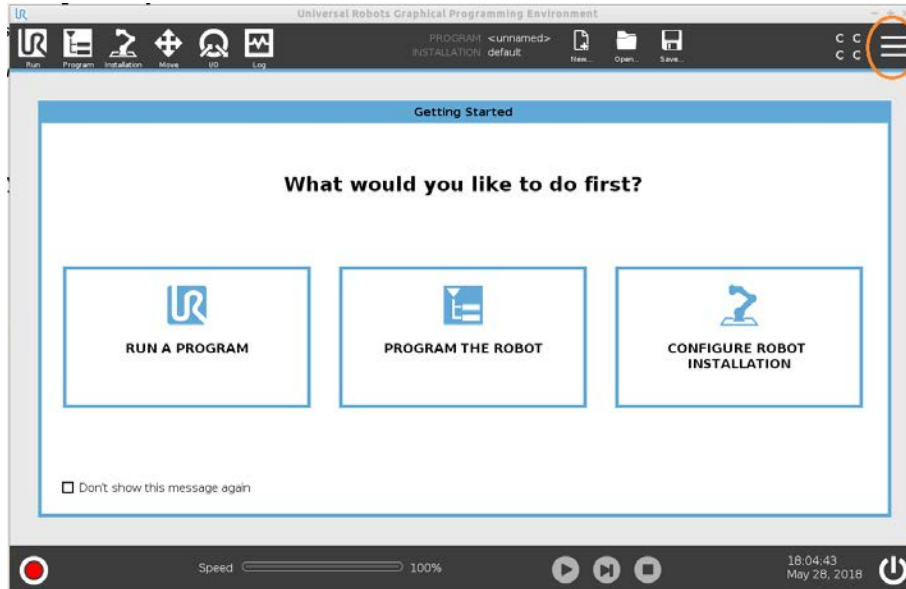

4. From the drop-down menu, select **Settings**.

**Figure 4.3—Select Settings**

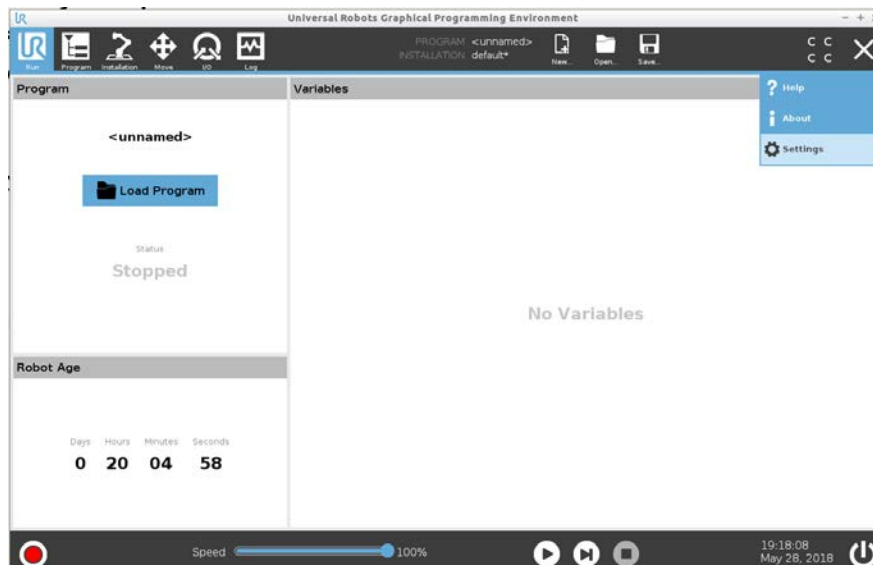

5. The **Settings** window opens. Load the file:
  - a. On the left side menu, select the **System** tab.
  - b. From the drop-down menu, select **URCaps**.
  - c. Select the + button on the lower left hand of the screen.

**Figure 4.4—Settings Window**

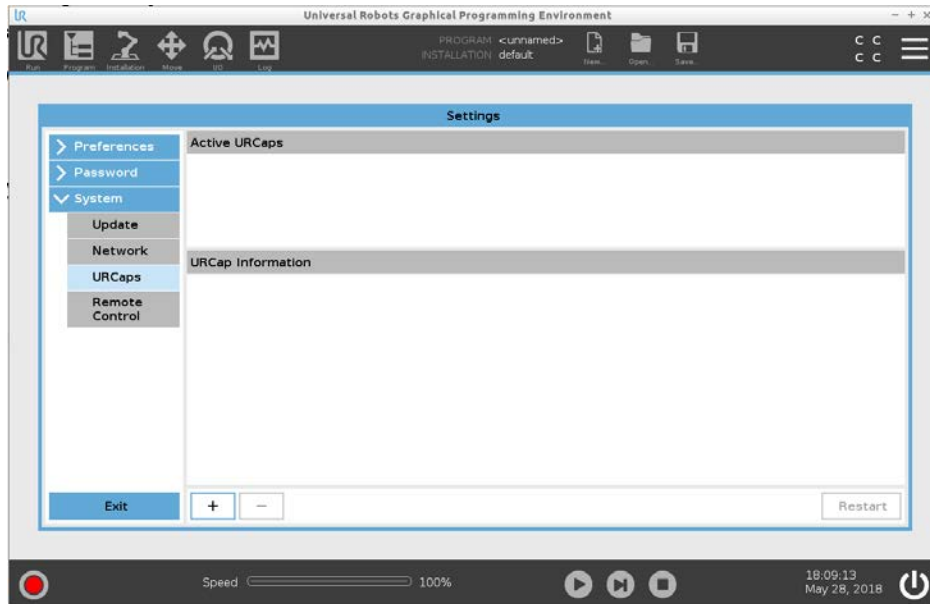

6. Navigate to the directory where the ATI F/T URCaps software file is saved on the USB drive.
7. Select the file.
8. Click **Open**. The file loads onto the teach pendant.

**Figure 4.5—Open the File**

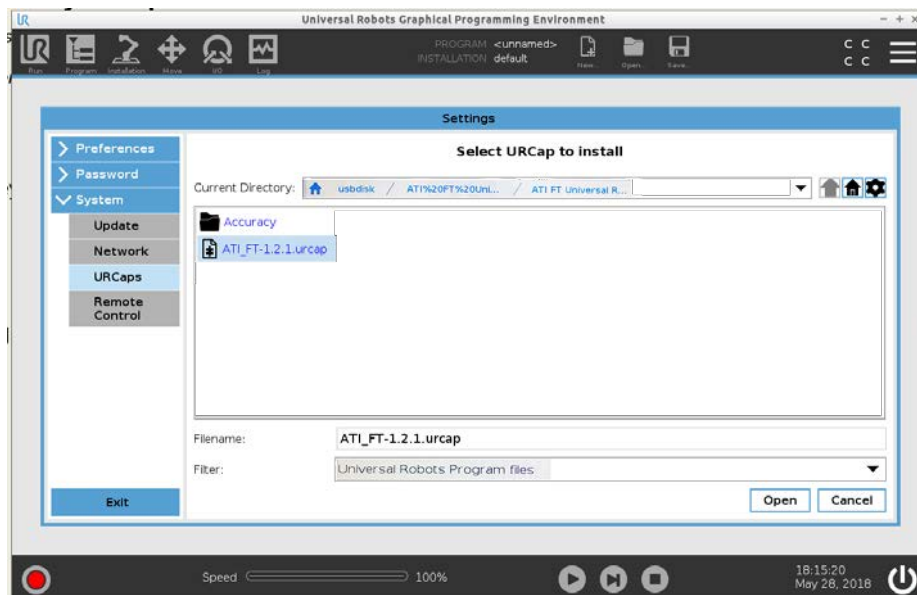



- When the file has loaded, the software **ATI Axia Force/Torque Sensor** appears in the **Active URcaps** field.

**NOTICE:** The UR system prompts a reboot of the robot, after the user installs the URcap software.

**Figure 4.6—Active URcaps**

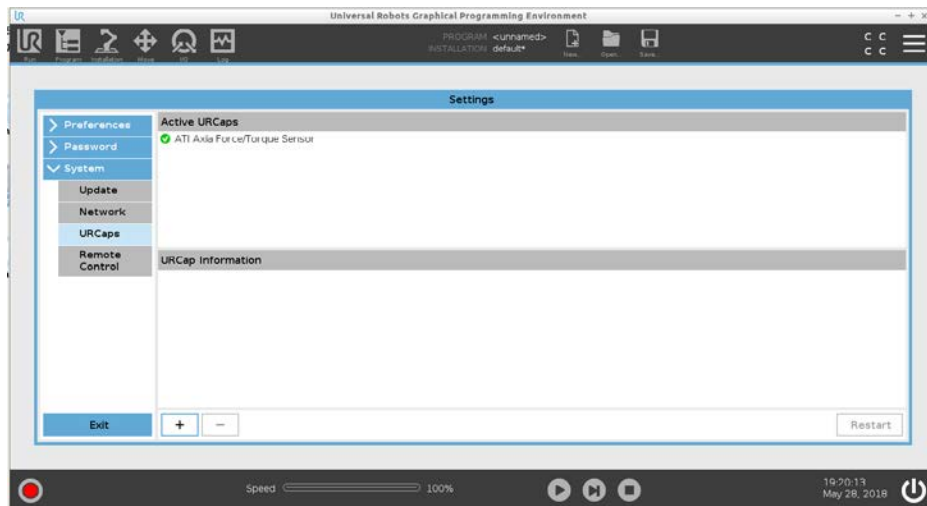

- (Optional) Select the file, **ATI Axia Force/Torque Sensor** and information appears in the **URCap Information** field.

**Figure 4.7—URcaps Information Field**



- Remove the USB drive.
- The user can now setup the sensor on the teach pendant:
  - For Ethernet, refer to [Section 4.3—Set-up an ATI F/T Ethernet Sensor on the Teach Pendant](#).
  - For Serial, refer to [Section 4.4—Set-up an ATI F/T Serial Sensor on the Teach Pendant](#).

## 4.2.1 Remove the ATI F/T URCaps Software from the Teach Pendant

To remove the ATI F/T URCaps software from the teach pendant, complete the following procedure:

1. On the upper right hand corner of the screen, select the **Hamburger** menu button.
2. From the drop-down menu, select **Settings**.
3. When the **Settings** window opens, select the **Systems** tab.
4. From the drop down menu, select **URCaps**.
5. In the **Active URCaps** field, select the file to uninstall from the teach pendant.
6. Click the - button on the lower left side of the screen.

Figure 4.8—Active URCaps

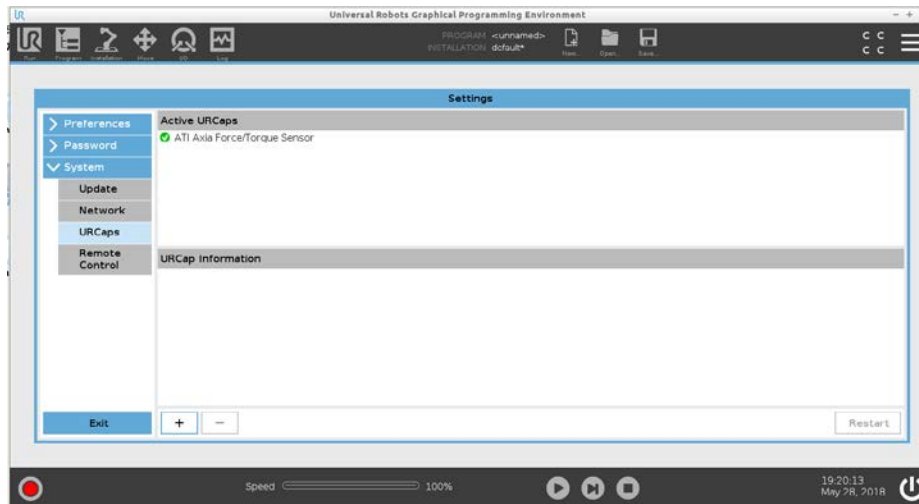

## 4.3 Set-up an ATI F/T Ethernet Sensor on the Teach Pendant

Once the user loads the ATI F/T URCaps software on the teach pendant, now the user may set-up the ATI F/T Ethernet sensor on the teach pendant.

1. On the footer, press the red **Initialize** button to activate the robot arm.

Figure 4.9—URCaps Information Field

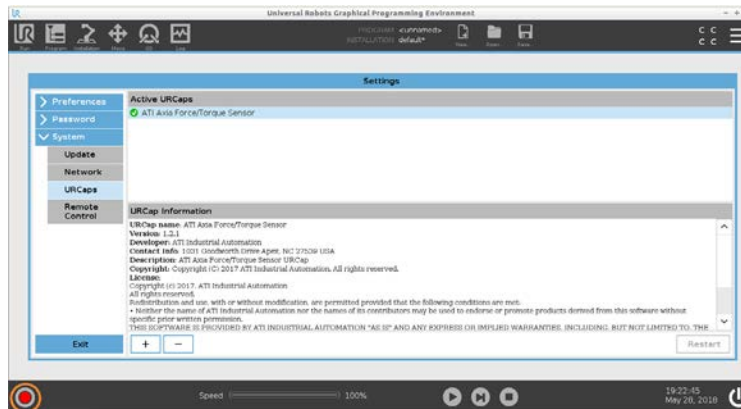

- a. On the **Initialize** screen press the **On** or **Start** button.

**Figure 4.10—Initialize Screen**

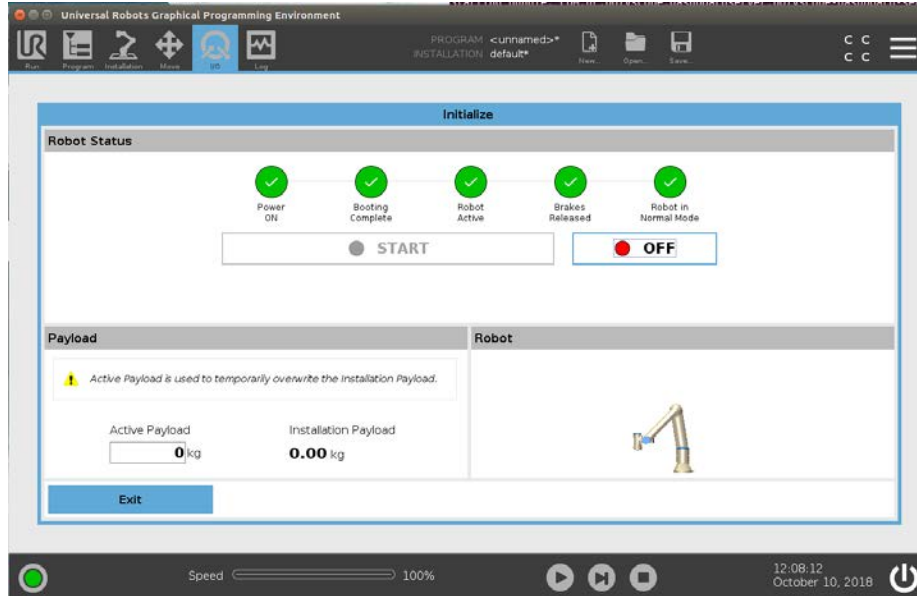

- b. In the **Robot Status** field, the green lights turn on as the robot arm becomes operational.
  - c. On the Ethernet Axia sensor body, the Status LED illuminates green.
  - d. Select **Exit**.
2. On the header, select the **Installation** icon.

**Figure 4.11—Installation Icon on the Teach Pendant Header**



3. On the left side menu ([Figure 4.12](#)), select the **General** tab, and from the drop-down menu, select **TCP**.

**NOTICE:** The TCP position, payload, and center of gravity information should include the ATI products (kits) plus the customer tooling.

- On the **Tool Center Point** screen, type values in the fields, as applicable to the application. For assistance in determining these values, refer to [Section 4.5—Determining the Tooling Mass and Offset](#).
  - Figure 4.12:** The values entered in this figure are an example of a configuration that includes the ATI mounting interface plate, the Axia sensor, and the tool interface plates. These values are from [9105-URe-Axia80 Kit Drawing](#). To these values, the user may need to add additional offset and payload to account for the customer tooling.

**Figure 4.12—TCP Screen (with tool interface plate)**

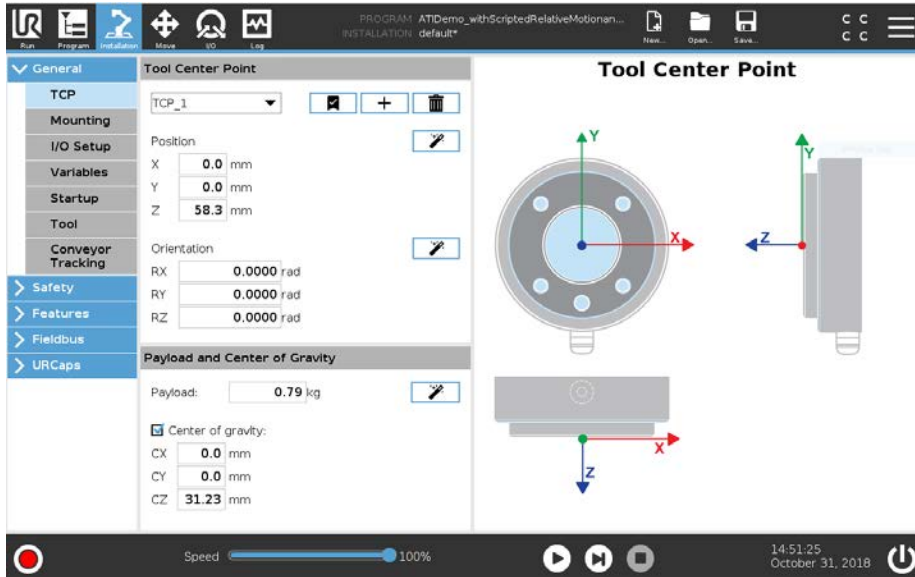

- Figure 4.13:** The values entered in this figure are an example of a configuration that includes the ATI mounting interface plate, the Axia sensor, and the tool interface plate. These values are from [9105-URe-Axia80 Kit Drawing](#). To these values, the user may need to add additional offset and payload to account for the customer tooling.

**Figure 4.13—TCP Screen (without tool interface plate)**

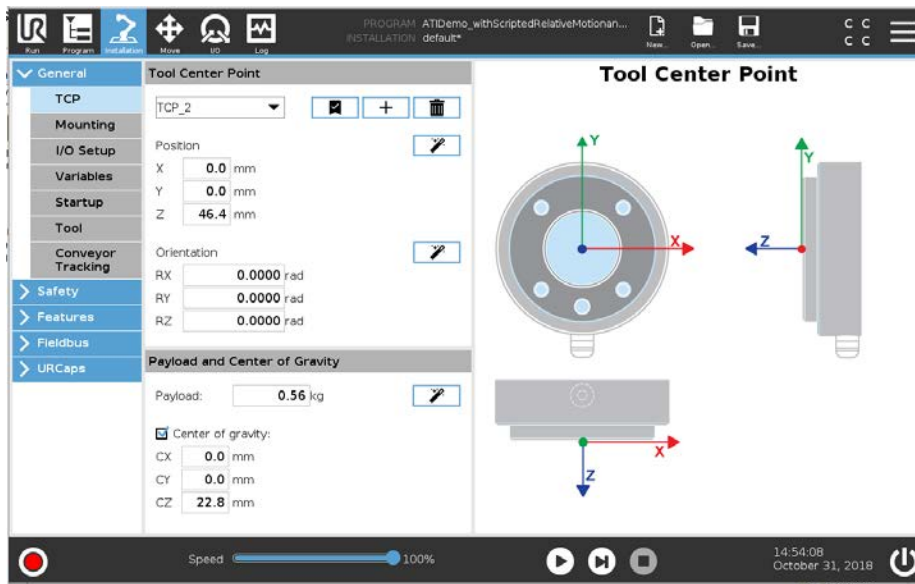

5. On the left side menu, select the **URcaps** tab to view the **Force/Torque Sensor** screen.
6. In the **F/T Sensor Address** field, type the IP address of the sensor: 192.168.1.1

**NOTICE:** ATI ships the sensor with a default IP address: 192.168.1.1. However, the user must set the sensor to an IP address on the same local subnet as the URE robot. For instructions on how to determine or change the IP address of the ATI F/T Ethernet sensor, refer to the applicable manual in [Table 2.1](#).

7. On the bottom of the screen, type the information for the following fields: **Sensor Mass**, **Sensor Measuring Offset**, and **Sensor Center of Gravity**.
  - In parenthesis, ATI includes recommended values next to the **Sensor Measuring Offset** and **Sensor Center of Gravity** fields. Use different values, if using a custom mounting interface plate.

**Figure 4.14—Tool Communication Interface Screen**

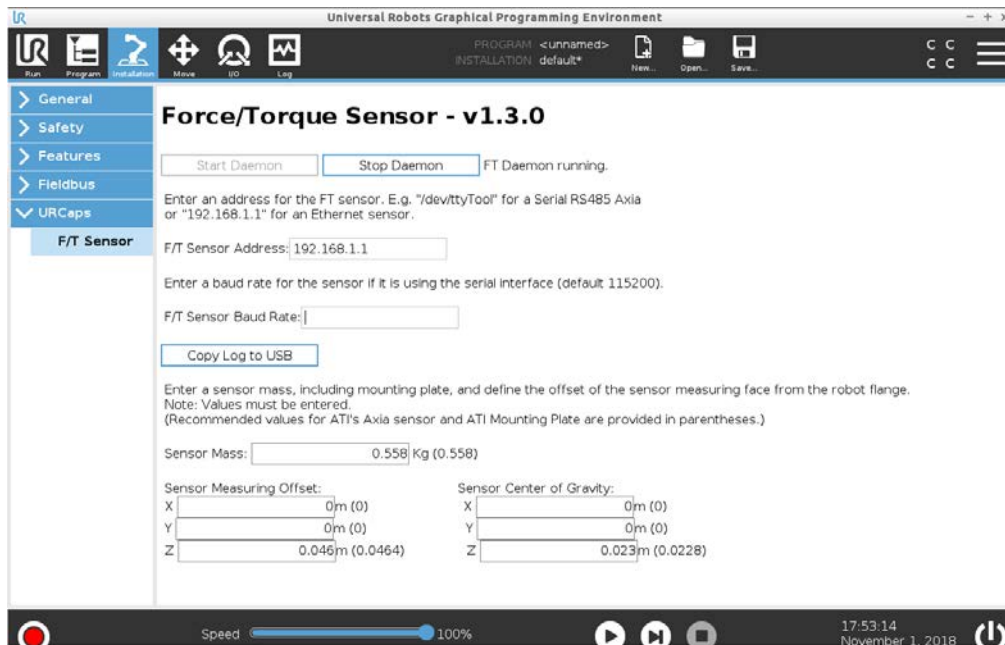

8. Press the **Start Daemon** button.

**NOTICE:** When the Daemon is running, the Stop Daemon is highlighted with a blue shadow box, and the notice “FT Daemon running” appears.



9. On the header, select the **Save** icon, and from the drop-down menu, select **Save Program As**. Save the file.

**NOTICE:** If the user is editing an existing program, then select **Save All** from the drop-down menu.

10. Once the sensor and robot are setup, the user can now create a program or run an ATI demo program (refer to the [9610-05-1041](#) manual for programming).

#### 4.4 Set-up an ATI F/T Serial Sensor on the Teach Pendant

Once the user loads the ATI F/T URCaps software on the teach pendant, the user may set-up the ATI F/T Serial sensor on the teach pendant.

1. On the footer, press the red **Initialize** button to activate the robot arm.

Figure 4.15—URCaps Information Field

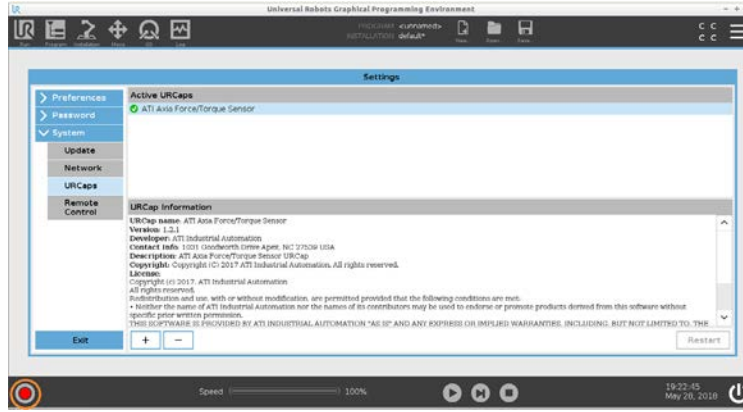

2. On the **Initialize** screen press the **On** or **Start** button.

Figure 4.16—Initialize Screen

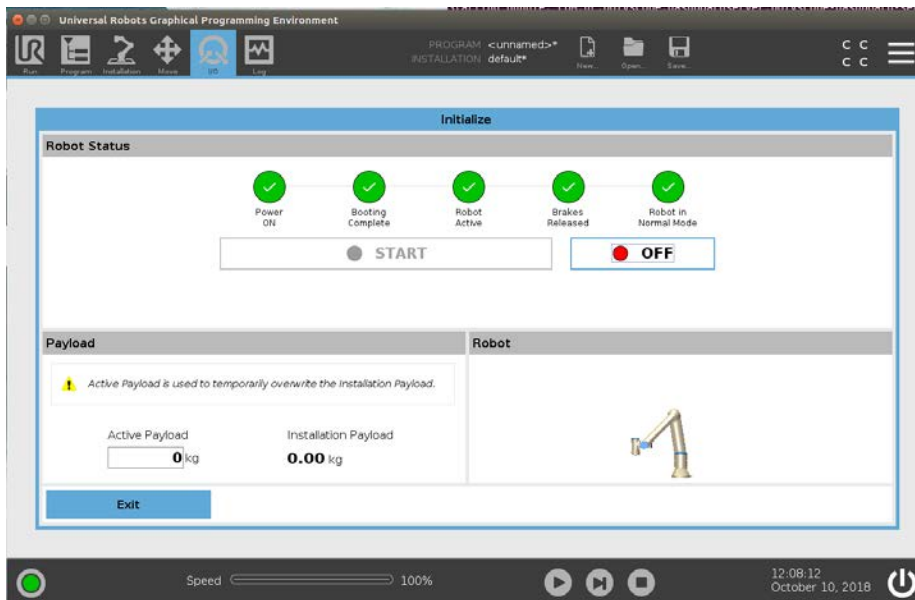

- a. In the **Robot Status** field, the green lights turn on as the robot arm becomes operational.
  - b. On the Serial Axia sensor, the Status LED turns green.
  - c. Select **Exit**.
3. On the header, select the **I/O** icon.

Figure 4.17—I/O Icon on the Teach Pendant Header



4. On the **I/O** icon screen, select the **Internal** tab.
  - a. Select **Robot**.
  - b. In the **Tool Output** field, move the blue ball on the **Voltage** line to **24** (this provides power to the sensor by way of the UR tool port).

Figure 4.18—I/O Screen

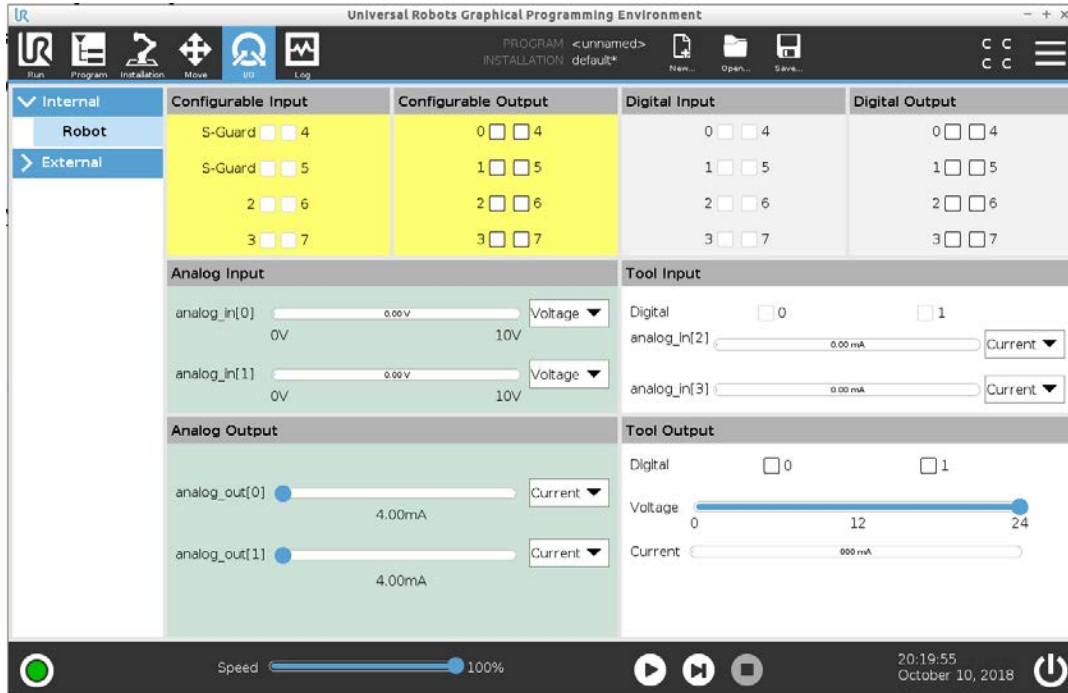

5. On the header, select the **Installation** icon.

Figure 4.19—Installation Icon on the Teach Pendant Header



6. On the left side menu (Figure 4.20), select the **General** tab, and from the drop-down menu, select **TCP**.

**NOTICE:** The TCP position, payload, and center of gravity information should include the ATI products (kits) plus the customer tooling.



- On the **Tool Center Point** screen, type values in the fields, as applicable to the application. For assistance in determining these values, refer to [Section 4.5—Determining the Tooling Mass and Offset](#).
  - Figure 4.20:** The values entered in this figure are an example of a configuration that includes the ATI mounting interface plate, the Axia sensor, and the tool interface plates. These values are from [9105-URe-Axia80 Kit Drawing](#). To these values, the user may need to add additional offset and payload to account for the customer tooling.

**Figure 4.20—TCP Screen (with tool interface plate)**

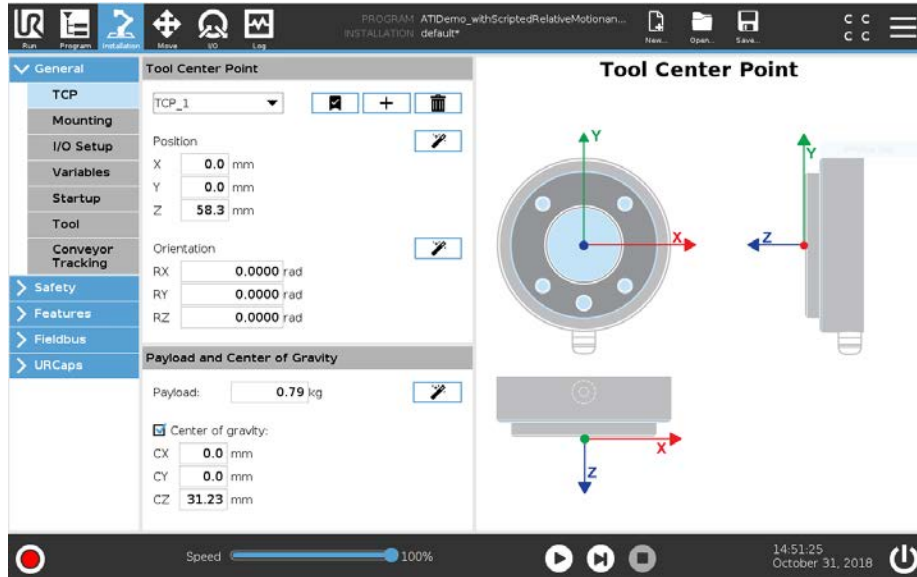

- Figure 4.21:** The values entered in this figure are an example of a configuration that includes the ATI mounting interface plate, the Axia sensor, and the tool interface plates. These values are from [9105-URe-Axia80 Kit Drawing](#). To these values, the user may need to add additional offset and payload to account for the customer tooling.

**Figure 4.21—TCP Screen (without tool interface plate)**

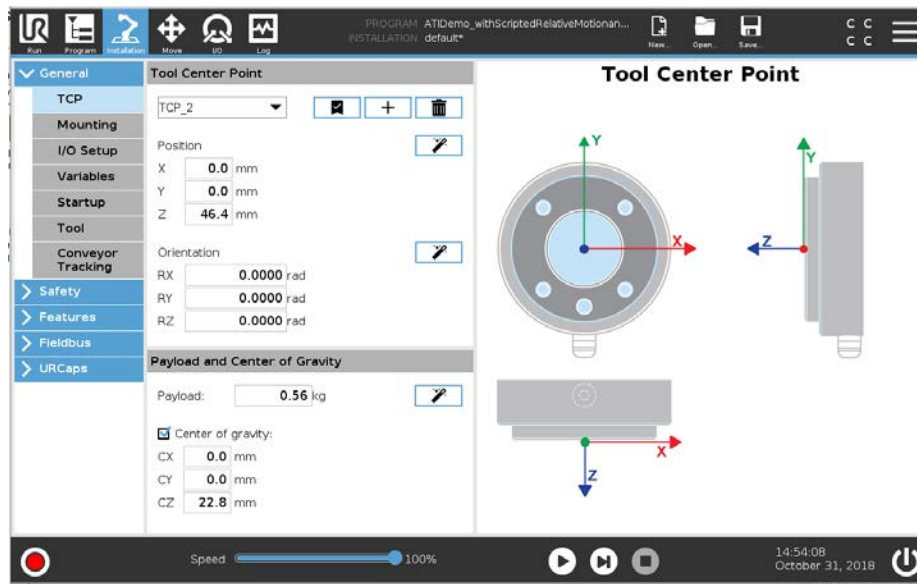



- On the left side menu, select the **General** tab, and from the drop-down menu, select **Tool** (refer to [Figure 4.22](#)).
- On the **Tool Communication Interface** screen, press the **Enable** button to enable the serial tool port on the robot's wrist.

**NOTICE:**

- Use the default values in [Figure 4.22](#) for these fields: Parity, Stop Bits, Rx Idle Chars, and Tx Idle Chars.
- Ensure the value in the Baud Rate field matches the sensor's set baud rate. To find the baud rate of the sensor, refer to the console commands in the [9610-05-Serial Axia](#) manual. If the sensor's baud rate does not match the robot's serial tool port baud rate, the sensor won't operate properly. ATI ships the sensor with a default baud rate that is 115200.

**Figure 4.22—Tool Communication Interface Screen**

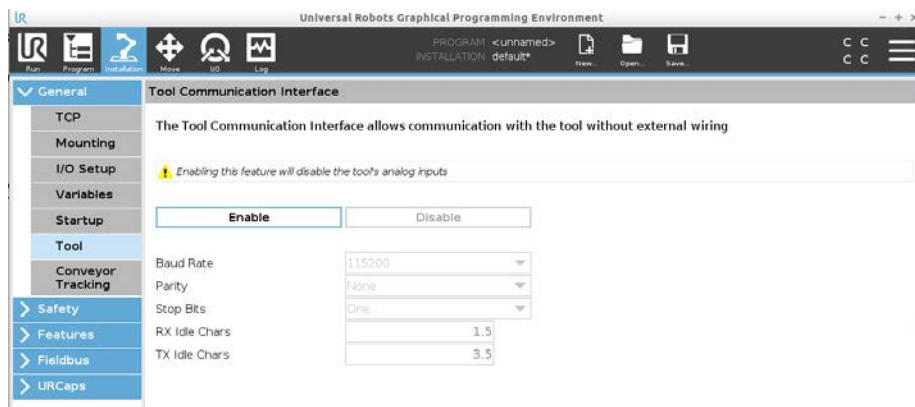

- On the left side menu, select the **URcaps** tab to view the **Force/Torque Sensor** screen.
- In the **F/T Sensor Address** field, type: `/dev/ttyTool`. This is the address of the URe robot's tool port.
- In the **F/T Sensor Baud Rate** field, type the baud rate at which the sensor is set.

**NOTICE:** Ensure the value in the Baud Rate field matches the baud rate at which the sensor is set. To find the baud rate of the sensor, refer to the console commands in the [9610-05-Serial Axia](#) manual. If the sensor's baud rate does not match the robot's serial tool port baud rate, the sensor won't operate properly. ATI ships the sensor with a default baud rate of 115200.

13. On the bottom of the screen, type the information for the following fields: **Sensor Mass**, **Sensor Measuring Offset**, and **Sensor Center of Gravity**. In parenthesis, ATI includes recommended values next to the **Sensor Measuring Offset** and **Sensor Center of Gravity** fields. Use different values, if using a custom mounting interface plate.

Figure 4.23—Tool Communication Interface Screen

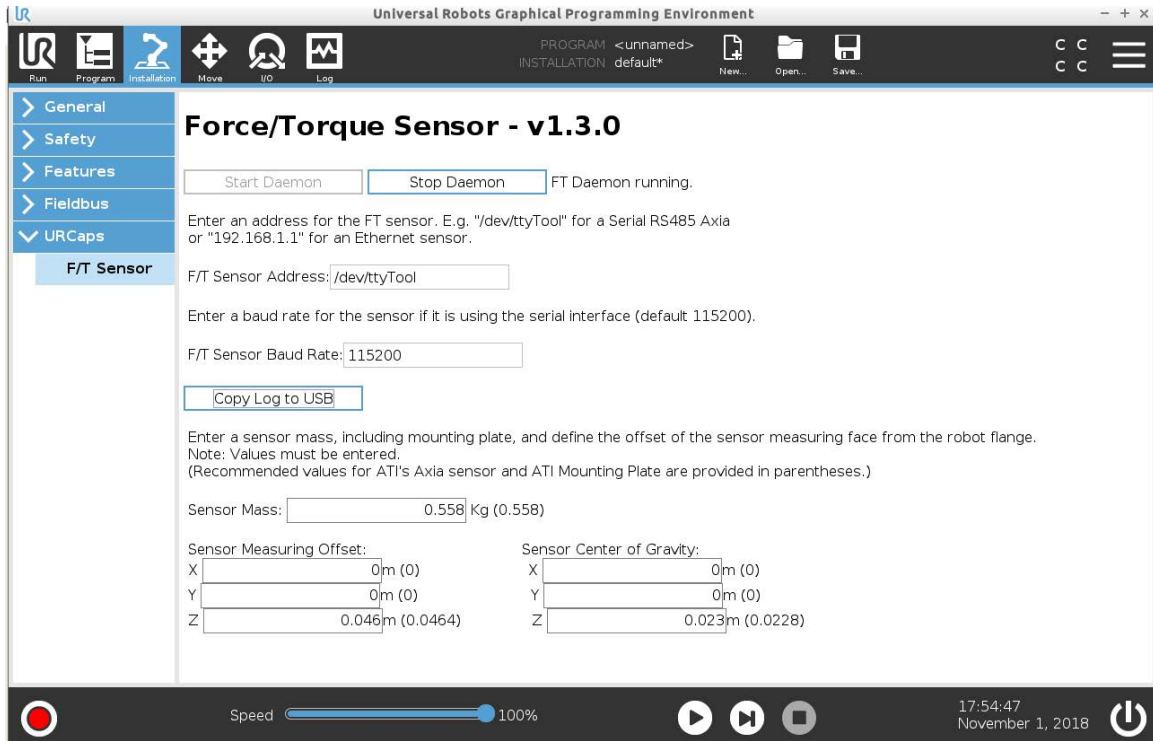

14. Press the **Start Daemon** button.

**NOTICE:** When the Daemon is running, the **Stop Daemon** is highlighted with a blue shadow box, and the notice “FT Daemon running” appears.



15. On the header, select the **Save** icon, and from the drop down menu, select **Save Program As**. Save the file.

**NOTICE:** If editing an existing program, then select **Save All** from the drop down menu.

16. Once the sensor and robot are setup, the user can now create a program or run an ATI demo program (refer to the [9610-05-1041](#) manual for programming).

## 4.5 Determining the Tooling Mass and Offset



**CAUTION:** Do not enter the following default values into the robot controller without accounting for the tooling mass by using the following equations. Failure to account for the tooling mass and offset reduces the performance of the UR robot. Properly account for the customer tooling, when setting up the tool center point or TCP.

Determining the tooling mass and offset depends upon the system configuration: sensor type, interface plate characteristics, and the customer tooling. The following sections explain how to calculate the mass and offset for two scenarios: a sensor with only a mounting interface plate or a sensor with mounting and tool interface plates.

### 4.5.1 Tooling Mass and Offset for a Sensor and Mounting Interface Plate

The ATI provided F/T sensor and mounting interface plate have the following mass characteristics, measuring offset, and CG with no customer tooling installed (refer to [9105-URe-Axia80 Kit Drawing](#) for more information):

Figure 4.24—Mass and Offset

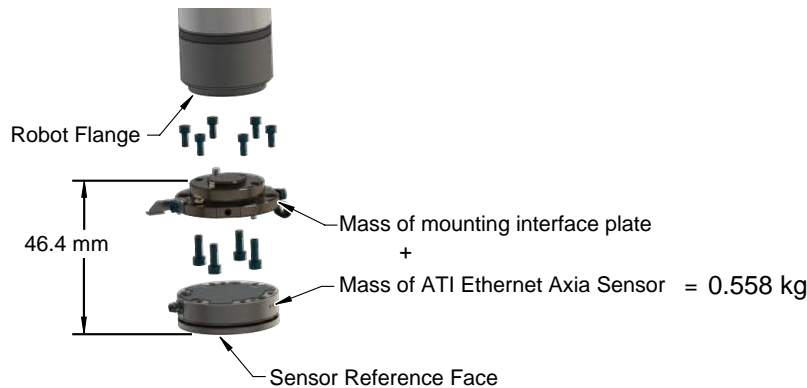

Table 4.1—Sensor and Mounting Interface Plate Mass

Sensor and Mounting Plate Models		
	ATI Axia F/T Sensor and ATI mounting interface plate	ATI F/T Ethernet Sensor and Custom Mounting Interface Plate <sup>2</sup>
Mass	0.558 kg <sup>1</sup>	mass (refer to the <a href="#">9620-05-Transducer Section</a> manual) + mass of the custom mounting interface plate
Notes:		
1. This value assumes the use of an ATI F/T Axia80 sensor and ATI 9105-IP-2126 mounting interface plate.		
2. Different sensor models and mounting plates have different measurements.		

Table 4.2—Sensor Measuring Offset (with mounting interface plate)		
Axis	Sensor and Mounting Interface Plate Models	
	ATI Axia F/T Sensor and ATI mounting interface plate	ATI F/T Ethernet Sensor and Custom Mounting Interface Plate <sup>2</sup>
X	0 m <sup>1</sup>	distance from the center of the robot flange to the center of the sensor reference face
Y	0 m <sup>1</sup>	
Z	0.0464 m <sup>1</sup>	
Notes:		
1. This value assumes the use of an ATI F/T Axia80 sensor and ATI 9105-IP-2126 mounting interface plate.		
2. Different sensor models and mounting plates have different measurements.		

Table 4.3—Sensor Center of Gravity (with mounting interface plate)		
Axis	Sensor and Mounting Plate Models	
	ATI Axia F/T Sensor and ATI mounting interface plate	ATI F/T Ethernet Sensor and Custom Mounting Interface Plate <sup>2</sup>
X	0 m <sup>1</sup>	distance from the center of the robot flange to the center of the CG of the sensor and mounting interface plate
Y	0 m <sup>1</sup>	
Z	0.0228 m <sup>1</sup>	
Notes:		
1. This value assumes the use of an ATI F/T Axia80 sensor and ATI 9105-IP-2126 mounting interface plate.		
2. Different sensor models and mounting plates have different measurements.		

Use the following equations in [Figure 4.26](#) to determine the values to enter in the fields of the TCP screen. Use the following diagram as a reference for the equations.

**Figure 4.25—Center of Gravity Diagram**

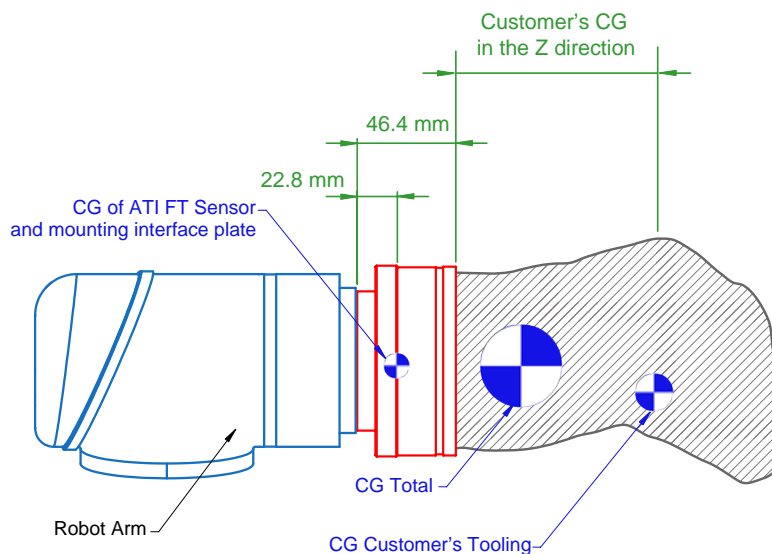

### Figure 4.26—Equations

Payload(kg)=0.558 kg +Customer's Tooling Mass

Center of Gravity (x, mm) =  $\frac{\text{Customer's Tooling Mass} \times \text{Customer's CG in the x direction}}{0.558 \text{ kg} + \text{Customer's Tooling Mass}}$

Center of Gravity (y, mm)= $\frac{\text{Customer's Tooling Mass} \times \text{Customer's CG in the y direction}}{0.558 \text{ kg} + \text{Customer's Tooling Mass}}$

Center of Gravity (z, mm)= $\frac{12.7224 \text{ kg-mm} + \text{Customer's Tooling Mass} \times (\text{Customer's CG in the z direction} + 46.4 \text{ mm})}{0.558 \text{ kg} + \text{Customer's Tooling Mass}}$

Where:

**Center of Gravity (CG):**

The point of a mass around which the resultant torque from gravity forces is zero.

**Customer's Center of Gravity in the X, Y, Z Direction:**

The distance in mm from the F/T sensor's sensing reference frame origin (refer to the customer drawing [9105-URe-Axia80 Kit Drawing](#)) to the center of gravity of the customer's tooling.

This should include the mass and location of all customer-provided fasteners and not ATI-provided parts.

The location of a center of gravity can be found in most CAD packages used to design robot tooling.

**Customer's Tooling Mass:**

The mass of the customer's tooling that includes all fasteners not provided by ATI, in kilograms.

**F/T Mass:**

The mass of the F/T sensor including the interface plate and all hardware required to connect the F/T sensor to the robot.

The F/T mass does not include any hardware the customer uses to mount tooling to the F/T sensor.

### 4.5.2 Tooling Mass and Offset for Sensor with Mounting and Tool Interface Plates

The ATI provided F/T sensor with mounting and tool interface plates have the following mass characteristics, measuring offset, and CG with no customer tooling installed (refer to [9105-URc-Axia80 Kit Drawing](#) for more information):

**Figure 4.27— Mass and Offset**

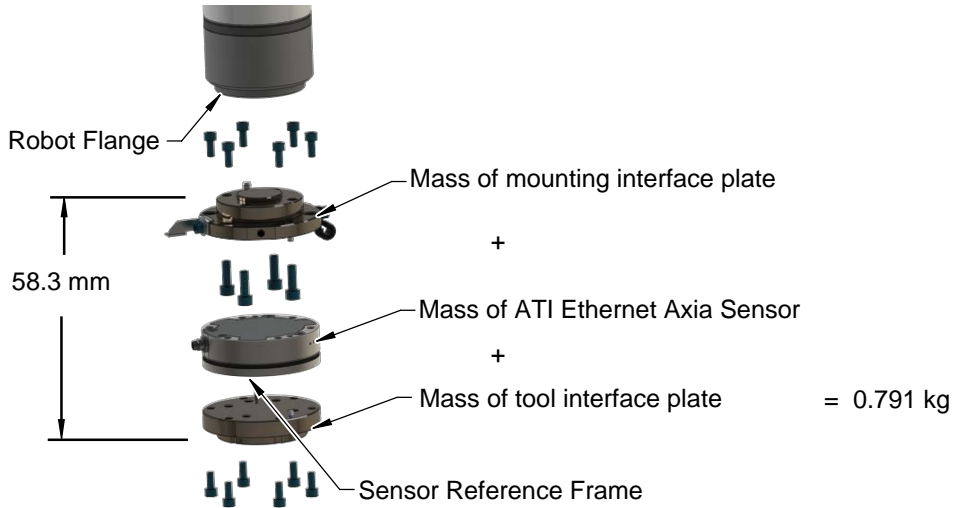

Table 4.4—Mass of a Sensor with Mounting and Tool Interface Plates		
Sensor and Interface Plate Models		
	ATI Axia F/T Sensor with Mounting and Tool Interface Plates	ATI F/T Ethernet Sensor with Custom Interface Plates <sup>2</sup>
<b>Mass</b>	0.791 kg <sup>1</sup>	mass (refer to the <a href="#">9620-05-Transducer Section</a> manual) + mass of the mounting interface plate + mass of the tool interface plate
Notes:		
1. This value assumes the use of an ATI F/T Axia80 sensor and ATI 9105-IP-2126 mounting interface plate and ATI 9105-IP-2191 tool interface plate.		
2. Different sensor models and interface plates have different measurements.		

Table 4.5—Measuring Offset with Mounting Interface Plate		
Axis	Sensor and Mounting Interface Plate Models	
	ATI Axia F/T Sensor with Mounting Interface Plate	ATI F/T Ethernet Sensor with Custom Mounting Interface Plate <sup>2</sup>
X	0 m <sup>1</sup>	distance from the center of the robot flange to the center of the sensor reference face
Y	0 m <sup>1</sup>	
Z	0.0464 m <sup>1</sup>	
Notes:		
1. This value assumes the use of an ATI F/T Axia80 sensor and ATI 9105-IP-2126 mounting interface plate. Tooling offsets, including interface plates, are not accounted for in sensor measuring offset. 2. Different sensor models and mounting plates have different measurements.		

Table 4.6—Center of Gravity of a Sensor with Mounting and Tool Interface Plates		
Axis	Sensor and Mounting Plate Models	
	ATI Axia F/T Sensor and ATI Mounting Interface Plate	ATI F/T Ethernet Sensor and Custom Mounting Interface Plate <sup>2</sup>
X	0 m <sup>1</sup>	distance from the center of the robot flange to the center of the CG of the sensor and custom mounting interface plate
Y	0 m <sup>1</sup>	
Z	0.0228 m <sup>1</sup>	
Notes:		
1. This value assumes the use of an ATI F/T Axia80 sensor and ATI 9105-IP-2126 mounting interface plate. Tooling, including interface plates, is not accounted for in the sensor center of gravity. 2. Different sensor models and mounting plates have different measurements.		

Use the equations in [Figure 4.29](#) to determine the values to enter in the fields of the TCP screen. Use the following diagram as a reference for the equations.

**Figure 4.28—Center of Gravity Diagram**

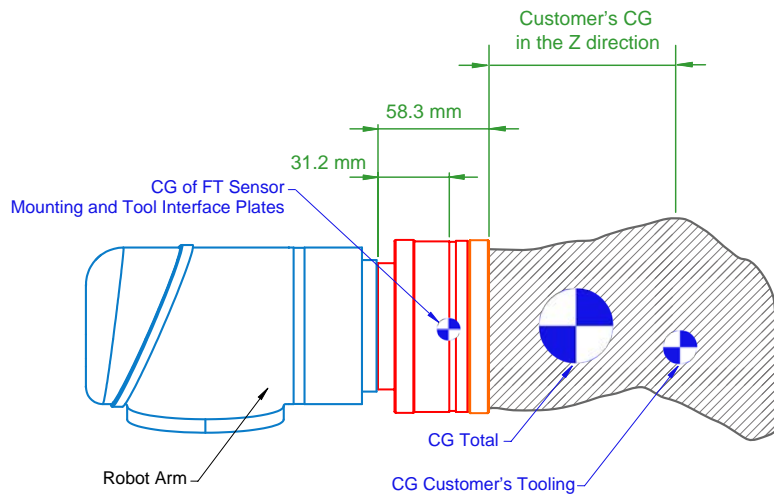

**Figure 4.29—Equations**

$$\text{Payload(kg)}=0.791 \text{ kg} +\text{Customer's Tooling Mass}$$

$$\text{Center of Gravity (x, mm)} = \frac{\text{Customer's Tooling Mass} \times \text{Customer's CG in the x direction}}{0.791 \text{ kg} + \text{Customer's Tooling Mass}}$$

$$\text{Center of Gravity (y, mm)} = \frac{\text{Customer's Tooling Mass} \times \text{Customer's CG in the y direction}}{0.791 \text{ kg} + \text{Customer's Tooling Mass}}$$

$$\text{Center of Gravity (z, mm)} = \frac{24.7 \text{ kg-mm} + \text{Customer's Tooling Mass} \times (\text{Customer's CG in the z direction} + 58.3 \text{ mm})}{0.791 \text{ kg} + \text{Customer's Tooling Mass}}$$

Where:

**Center of Gravity (CG):**

The point of a mass around which the resultant torque from gravity forces is zero.

**Customer's Center of Gravity in the X, Y, Z Direction:**

The distance in mm from the F/T sensor's sensing reference frame origin (refer to [9105-URe-Axia80 Kit Drawing](#)) to the center of gravity of the customer's tooling.

This should include the mass and location of all customer-provided fasteners and not ATI-provided parts.

The location of a center of gravity can be found in most CAD packages used to design robot tooling.

**Customer's Tooling Mass:**

The mass of the customer's tooling that includes all fasteners not provided by ATI, in kilograms.

**F/T Mass:**

The mass of the F/T sensor including the interface plate and all hardware required to connect the F/T sensor to the robot.

The F/T mass does not include any hardware the customer uses to mount tooling to the F/T sensor.



## 5. Troubleshooting

This section includes answers to some issues that might arise when setting up and using the ATI UPCaps software with an ATI sensor. In , the question or problem is listed on the left followed by the plausible solution to the right.

The information in this section should answer many questions that might arise in the field. Customer service is available to users, who have problems or questions addressed in the manuals.

### Note

Please read the manual before calling customer service. Before calling, have the following information available:

1. Serial number (e.g., FT01234)
2. Sensor model (e.g., Ethernet Axia80)
3. Calibration (e.g., US-15-50, SI-65-6, etc.)
4. Accurate and complete description of the question or problem
5. Computer and software information (operating system, PC type, drivers, application software, and other relevant information about the application's configuration)

If possible, be near the F/T system when calling.

For additional troubleshooting information or to speak with a customer service representative, please contact ATI:

### ATI Industrial Automation

1031 Goodworth Drive  
Apex, NC 27539 USA  
[www.ati-ia.com](http://www.ati-ia.com)  
Tel: +1.919.772.0115  
Fax: +1.919.772.8259

### Application Engineering

Tel: +1.919.772.0115, Extension 511  
Fax: +1.919.772.8259  
E-mail: [ft\\_support@ati-ia.com](mailto:ft_support@ati-ia.com)

## 5.1 Errors with the ATI URcap Software

The following table lists basic problems and possible answers/solutions for the operation of the ATI URcap software.

Table 5.1—Errors with the ATI URcap Software	
Problem	Answer/Solution
After clicking <b>Start Daemon</b> on the <b>Force/Torque Sensor</b> screen, an error message "ATI FT Daemon failed appears.	The ATI F/T Sensor address entered may be incorrect. Verify the address and reenter. Refer to <a href="#">Section 4.3—Set-up an ATI F/T Ethernet Sensor on the Teach Pendant</a> or <a href="#">Section 4.4—Set-up an ATI F/T Serial Sensor on the Teach Pendant</a> .
The ATI F/T sensor is malfunctioning.	Refer to the applicable manual in <a href="#">Table 2.1</a> .

## 6. Terms and Conditions of Sale

The following Terms and Conditions are a supplement to and include a portion of ATI's Standard Terms and Conditions, which are on file at ATI and available upon request.

ATI warrants to Purchaser that force torque sensor products purchased hereunder will be free from defects in material and workmanship under normal use for a period of one (1) year from the date of shipment. The warranty period for repairs made under a RMA shall be for the duration of the original warranty, or ninety (90) days from the date of repaired product shipment, whichever is longer. ATI will have no liability under this warranty unless: (a) ATI is given written notice of the claimed defect and a description thereof with thirty (30) days after Purchaser discovers the defect and in any event, not later than the last day of the warranty period and (b) the defective item is received by ATI not later than ten days after the last day of the warranty period. ATI's entire liability and Purchaser's sole remedy under this warranty is limited to repair or replacement, at ATI's election, of the defective part or item or, at ATI's election, refund of the price paid for the item. The foregoing warranty does not apply to any defect or failure resulting from improper installation, operation, maintenance, or repair by anyone other than ATI.

ATI will in no event be liable for incidental, consequential, or special damages of any kind, even if ATI has been advised of the possibility of such damages. ATI's aggregate liability will in no event exceed the amount paid by the purchaser for the item which is the subject of claim or dispute. ATI will have no liability of any kind for failure of any equipment or other items not supplied by ATI.

No action against ATI, regardless of form, arising out of or in any way connected with products or services supplied hereunder, may be brought more than one year after the cause of action accrued.

No representation or agreement varying or extending the warranty and limitation of remedy provisions contained herein is authorized by ATI, and may not be relied upon as having been authorized by ATI, unless in writing and signed by an executive officer of ATI.

Unless otherwise agreed in writing by ATI, all designs, drawings, data, inventions, software, and other technology made or developed by ATI in the course of providing products and services hereunder, and all rights therein under any patent, copyright, or other law protecting intellectual property, shall be and remain ATI's property. The sale of products or services hereunder does not convey any expressed or implied license under any patent, copyright, or other intellectual property right owned or controlled by ATI, whether relating to the products sold or any other matter, except for the license expressly granted below.

In the course of supplying products and services hereunder, ATI may provide or disclose to Purchaser confidential and proprietary information of ATI relating to the design, operation, or other aspects of ATI's products. As between ATI and Purchaser, ownership of such information, including without limitation any computer software provided to Purchaser by ATI, shall remain in ATI and such information is licensed to Purchaser only for Purchaser's use in operating the products supplied by ATI hereunder in Purchaser's internal business operations.

Without ATI's prior written permission, Purchaser will not use such information for any other purpose or provide or otherwise make such information available to any third party. Purchaser agrees to take all reasonable precautions to prevent any unauthorized use or disclosure of such information.

Purchaser will not be liable hereunder with respect to disclosure or use of information which: (a) is in the public domain when received from ATI, (b) is thereafter published or otherwise enters the public domain through no fault of Purchaser, (c) is in Purchaser's possession prior to receipt from ATI, (d) is lawfully obtained by Purchaser from a third party entitled to disclose it, or (f) is required to be disclosed by judicial order or other governmental authority, provided that, with respect to such to maintain the confidentiality of such information.