

Table of Contents

D. Pneumatic and Fluid Modules	D-2
AL2—Air Module	D-2
1. Product Overview	D-2
2. Installation	D-3
2.1 Module Installation	D-3
2.2 Module Removal	D-4
3. Operation	D-5
4. Maintenance	D-5
5. Troubleshooting and Service Procedures	D-6
5.1 Troubleshooting Procedures	D-6
5.2 Service Procedures	D-7
5.2.1 AL2 Master Side Self-Sealing Valve.....	D-7
5.2.2 AL2 Tool Side Self-Sealing Valve	D-9
6. Serviceable Parts	D-10
6.1 AL2 Tool Valve Serviceable Parts	D-10
7. Specifications	D-11
8. Drawings	D-12
8.1 AL2 Module Drawing	D-12

D. Pneumatic and Fluid Modules

AL2—Air Module

1. Product Overview

Fluid/air modules provide fluid and air utility, and are attached to the Master and Tool plates. When the Tool Changer is coupled, the Master module passes the fluid/air supply to the Tool module for use by the customer tooling. Significant forces are encountered when using these modules. Assistance from the robot may be required to overcome these forces when coupling the Tool Changer.

NOTICE: The Master and Tool modules contain self-sealing valves. Do not use self-sealing valves for vacuum utility.

Refer to [Figure 1.1](#), [Section 7—Specifications](#), and [Section 8—Drawings](#) for more information.

Figure 1.1—AL2 Modules

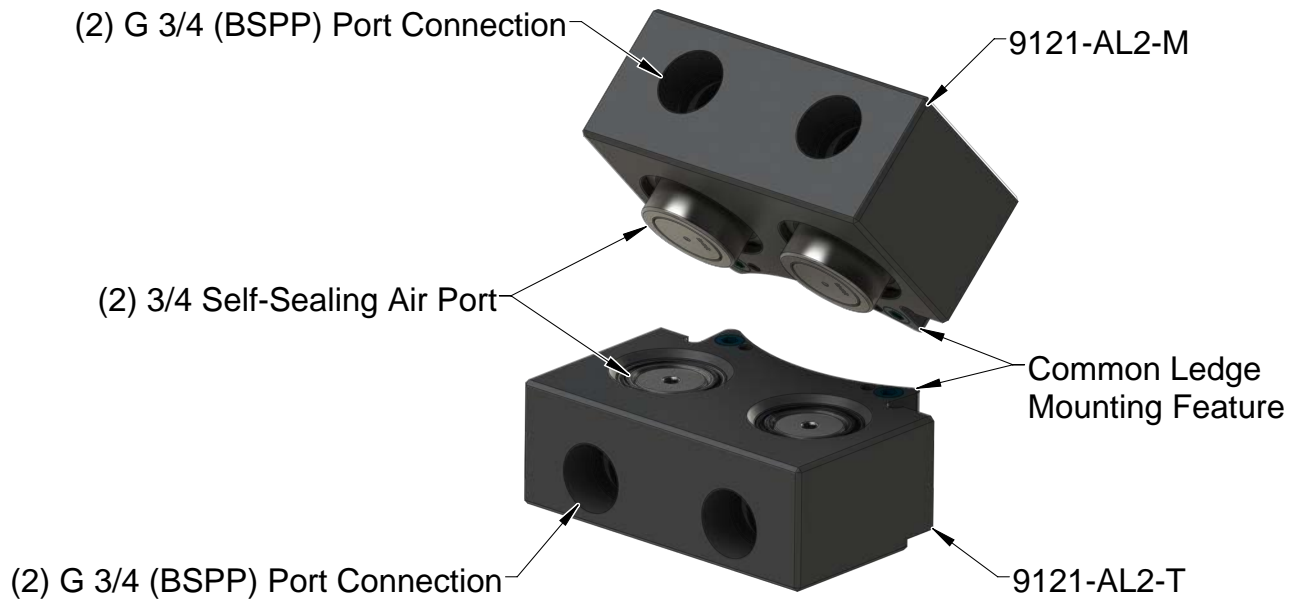

2. Installation

Air modules are typically installed by ATI prior to shipment. Use the following steps to install or remove air modules.



WARNING: Do not perform maintenance or repair(s) on the Tool Changer or modules unless the Tool is safely supported or placed in the tool stand, all energized circuits (e.g. electrical, air, water, etc.) are turned off, pressurized connections are purged and power is discharged from circuits in accordance with the customer's safety practices and policies. Injury or equipment damage can occur with the Tool not placed and energized circuits on. Place the Tool in the tool stand, turn off and discharge all energized circuits, purge all pressurized connections, and verify all circuits are de-energized before performing maintenance or repair(s) on the Tool Changer or modules.



CAUTION: Do not use fasteners with pre-applied adhesive more than once. Fasteners might become loose and cause equipment damage. Always apply new thread locker when reusing fasteners.



CAUTION: Air supply should be clean, dry, and non-lubricated. Supply pressure must not exceed 100 psi and should be filtered minimum 40 micron. Connection lines must be properly strain relieved.

2.1 Module Installation

NOTICE: On the AL2, verify that the Master side valve pistons are seated flush with the valve stem; otherwise, the pistons can swivel inside the housing on the AL2. Refer to [Figure 2.1](#).

Tools required: 5 mm Allen wrench (hex key), torque wrench

Supplies required: Clean rag, Loctite® 242

1. Place the Tool in a secure location.
2. Uncouple the Master and Tool plates.
3. Turn off and de-energize all energized circuits (e.g. electrical, air, water, etc.).
4. Clean the mounting surface on the Tool Changer or Utility Coupler.
5. Place the module into the appropriate location on the Tool Changer or Utility Coupler body. Align the module with the Tool Changer using the dowels in the bottom of the ledge feature.
6. Apply Loctite 242 to the supplied M6 socket head cap screws. Using a 5 mm Allen wrench, install the (2) M6 socket head cap screws securing the module to the Tool Changer or Utility Coupler and tighten to 89 in-lbs (10.0 Nm).
7. Connect air plumbing to the module. Ensure that the connectors are clean.
8. After the procedure is complete, resume normal operation.

Figure 2.1—Master Module Installation

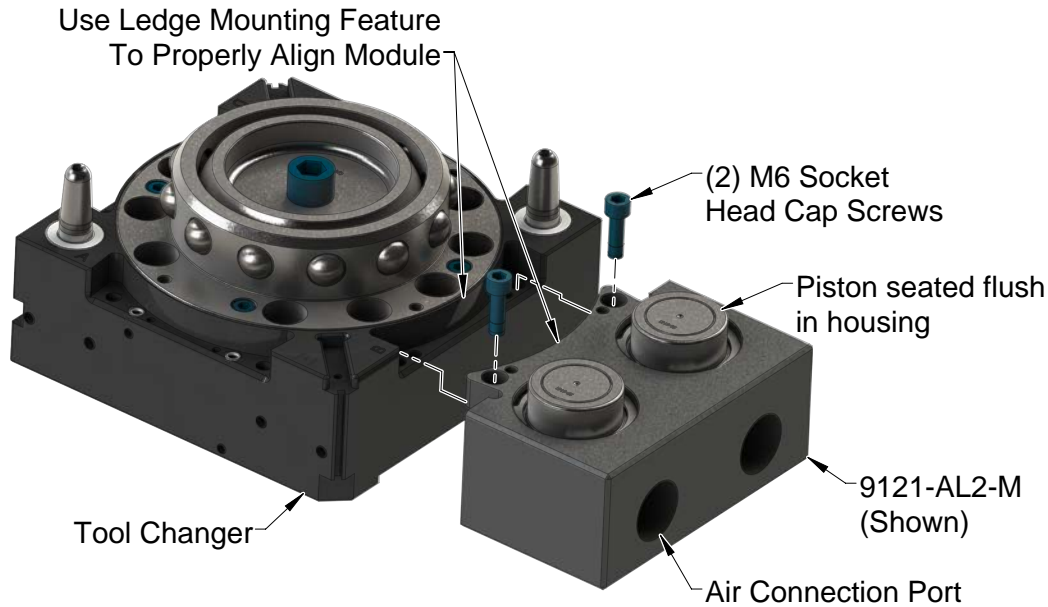

2.2 Module Removal

Tools required: 5 mm Allen wrench

Supplies required: Clean rag

1. Place the Tool in a secure location.
2. Uncouple the Master and Tool plates.
3. Turn off and de-energize all energized circuits (e.g. electrical, air, water, etc.).

NOTICE: Debris can be expelled at high velocity during the purge, take all required safety precautions.

4. All customer plumbing connections to the module must be purged.
 - a. Verify that the supply lines are turned off.
 - b. Cover the valves with a rag for safety.
 - c. Manually actuate the self-sealing valves to purge the line pressure.
5. Use a marker pen to indicate where the module is to be re-installed.
6. Disconnect air plumbing to the module.
7. Remove the (2) M6 socket head cap screws using a 5 mm Allen wrench
8. Remove the module from the Tool Changer or Utility Coupler.

3. Operation

During a tool change, self-sealing valves prevent the air circuits from discharging, which eliminates the need to close upstream circuits. The self-sealing and pass-through ports operate at a maximum pressure of 100 psi (6.9 bar).

4. Maintenance

Perform maintenance to maximize the operational life of the module.

	<p>WARNING: Do not perform maintenance or repair(s) on the Tool Changer or modules unless the Tool is safely supported or placed in the tool stand, all energized circuits (e.g. electrical, air, water, etc.) are turned off, pressurized connections are purged and power is discharged from circuits in accordance with the customer's safety practices and policies. Injury or equipment damage can occur with the Tool not placed and energized circuits on. Place the Tool in the tool stand, turn off and discharge all energized circuits, purge all pressurized connections, and verify all circuits are de-energized before performing maintenance or repair(s) on the Tool Changer or modules.</p>
---	--

A preventive maintenance schedule and checklist are provided in the following tables:

Table 4.1—Preventive Maintenance Schedule	
Inspection Schedule	Action Required
Weekly	Clean and inspect
6 months or 500,000 cycles	Seal replacement

Table 4.2—Preventive Maintenance Checklist
<p>Weekly Maintenance:</p> <ul style="list-style-type: none"> <input type="checkbox"/> Clean mating surfaces using a nylon brush. <input type="checkbox"/> Inspect modules for air leaks. Replace components as necessary.
<p>6 months or 500,000 cycle Maintenance:</p> <ul style="list-style-type: none"> <input type="checkbox"/> On AL2 modules with self-sealing ports, remove and replace self-sealing valve O-rings and seals in both the Master and Tool module. During O-ring and seal replacement inspect components (valve stem, valve piston, and spring) of the valve assemblies in the Master and Tool modules. Refer to Section 5.2.1—AL2 Master Side Self-Sealing Valve or Section 5.2.2—AL2 Tool Side Self-Sealing Valve. <input type="checkbox"/> Check that module mounting bolts are secure. Refer to Section 2.1—Module Installation.

5. Troubleshooting and Service Procedures

The following section provides troubleshooting information to help diagnose conditions with the Tool Changer or air module and service procedures to help resolve these conditions.



WARNING: Do not perform maintenance or repair(s) on the Tool Changer or modules unless the Tool is safely supported or placed in the tool stand, all energized circuits (e.g. electrical, air, water, etc.) are turned off, pressurized connections are purged and power is discharged from circuits in accordance with the customer's safety practices and policies. Injury or equipment damage can occur with the Tool not placed and energized circuits on. Place the Tool in the tool stand, turn off and discharge all energized circuits, purge all pressurized connections, and verify all circuits are de-energized before performing maintenance or repair(s) on the Tool Changer or modules.

5.1 Troubleshooting Procedures

Refer to the following table for troubleshooting information:

Table 5.1—Troubleshooting Procedures		
Symptom	Possible Cause	Correction
Air Leakage	Damaged/Worn seals	Replace the seals as needed. Refer to Section 5.2.1—AL2 Master Side Self-Sealing Valve or Section 5.2.2—AL2 Tool Side Self-Sealing Valve .
	Debris blocking valve seal (for self-sealing valves)	Clean in and around valve components. Ensure the air stream is free of large particulates; filter as necessary.
	Bent valve stem (for self-sealing valves)	Replace the stem. Refer to Section 5.2.2—AL2 Tool Side Self-Sealing Valve . Check the module attachment to Tool Changer. Refer to Section 2.1—Module Installation . Check the robot program and ensure there is a parallel approach trajectory during Tool Changer coupling.
	Corrosion	Consult ATI for assistance.
Poor Flow	Air hose supply/return lines or connections are damaged or blocked.	Inspect the supply/return hoses and connections for damage or blockage. Clean, repair, or replace as necessary.
	Debris blocking valve seal (for self-sealing valves)	Clean in and around the valve components. Ensure the air stream is free of large particulates; filter as necessary.
Modules are unable to couple	Bent valve stem (for self-sealing valves)	Replace the stem. Refer to Section 5.2.2—AL2 Tool Side Self-Sealing Valve . Check the module attachment to the Tool Changer. Refer to Section 2.1—Module Installation . Check the robot program and ensure there is a parallel approach trajectory during Tool Changer coupling.

5.2 Service Procedures

The following service procedures provide instructions for component replacement and adjustment.

5.2.1 AL2 Master Side Self-Sealing Valve

Parts Required: Refer to [Section 8.1—AL2 Module Drawing](#).

Tools required: Snap ring pliers

Supplies required: Clean rag, Magnalube

1. Place the Tool in a secure location.
2. Uncouple the Master and Tool plates.
3. Turn off and de-energize all energized circuits (e.g. electrical, air, water, etc.).

NOTICE: Debris can be expelled at high velocity during the purge, take all required safety precautions.

4. Purge and disconnect all customer plumbing connections to the module.
 - a. Turn the supply lines off.
 - b. Cover the valves with a rag for safety.
 - c. Manually actuate the module's self-sealing valves to purge the line pressure.
5. Remove the retaining ring using snap ring pliers.
6. Remove the valve stem, valve piston and spring, inspect for wear or damage. Replace any worn or damaged components.
7. Remove the O-rings from the valve piston and the valve bore in the housing.
8. Clean the valve bore and internal components with a clean dry rag.

Figure 5.1—Master Self-Sealing Valve

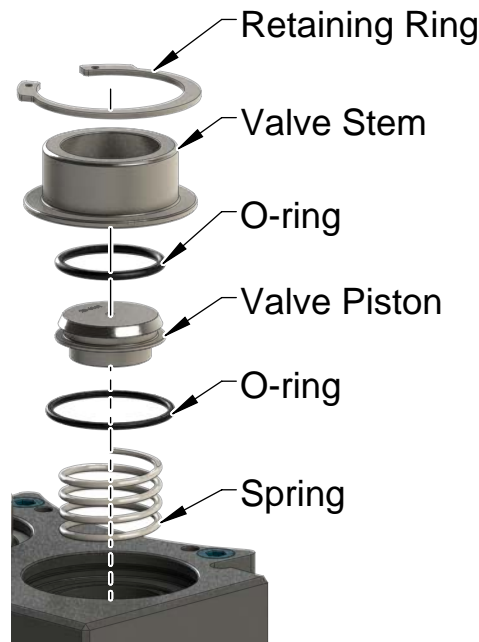
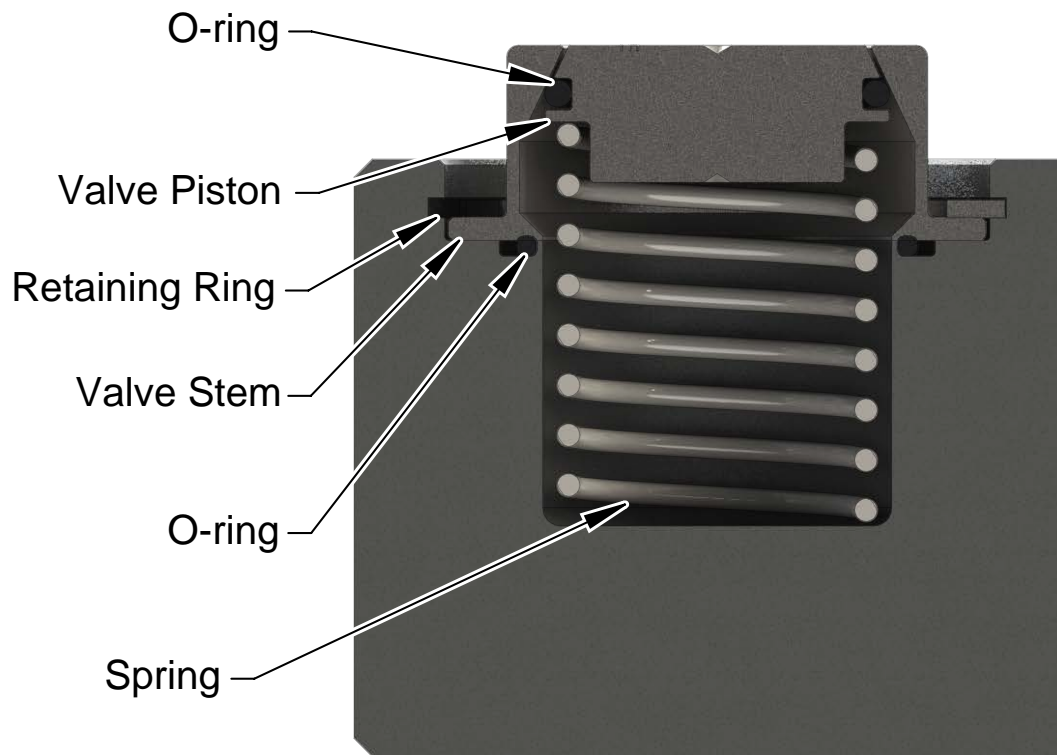

Figure 5.2—Master Self-Sealing Valve Cross Sectional View



9. Lubricate the replacement O-rings and valve piston with Magnalube.
10. Place the larger O-ring on the seat of the valve bore.
11. Place the smaller O-ring in the groove of the valve piston.
12. Place the spring to the bottom boss of the valve piston, and insert into the valve bore.
13. Place the valve stem in the bore of the housing so that the stem's flange rests on the seat of the housing. The valve piston should be flush with the top rim of the valve stem.
14. Using snap ring pliers, secure the self-sealing valve assembly by installing the retaining ring in the groove of the housing.
15. After the procedure is complete, resume normal operation.

5.2.2 AL2 Tool Side Self-Sealing Valve

Parts required: Refer to [Section 6.1—AL2 Tool Valve Serviceable Parts](#).

Tools Required: Spanner wrench (legacy product) or 5 mm Allen wrench (latest product revision)

Supplies Required: Clean rag, Magnalube G lubricant, Loctite 242

1. Place the Tool in a secure location.
2. Uncouple the Master and Tool plates.
3. Turn off and de-energize all energized circuits, for example, electrical, air, and water.

NOTICE: Debris can be expelled at high velocity during the purge; take all required safety precautions.

4. Purge and disconnect all customer plumbing connections to the module.
 - a. Turn the supply lines off.
 - b. Cover the valves with a rag for safety.
 - c. Manually actuate the module's self-sealing valves to purge the line pressure.
5. Use a spanner wrench or 5 mm Allen wrench to remove the valve stem assembly, the valve piston assembly, and spring from the housing.

Figure 5.3—Remove Valve Stem Assembly, Valve Piston Assembly, and Spring

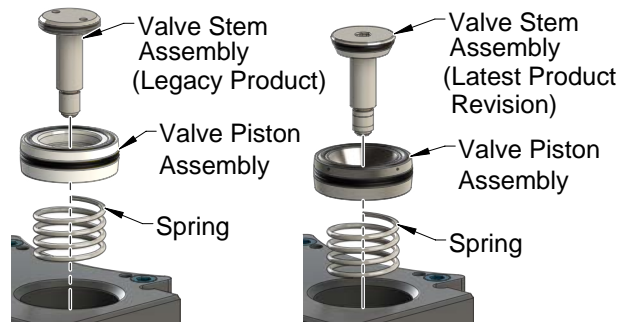

6. Inspect the valve stem, valve piston, and the spring for wear or damage; replace all worn or damaged components.
7. Remove all O-ring and Quad-ring seals from the valve stem and piston assemblies.

Figure 5.4—Replace the O-rings and Quad-rings

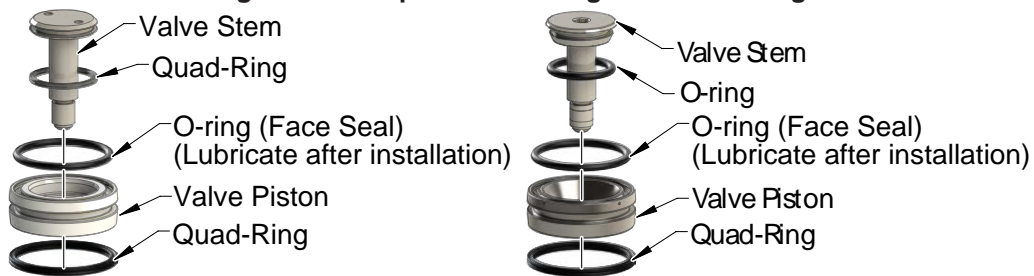

NOTICE: Do not lubricate the O-ring face seal for the valve piston prior to installation.

8. Lubricate the replacement valve Piston Quad-ring and the valve stem Quad-ring or O-ring.
9. Install the O-ring face seal into the top groove in the valve piston. Then lubricate the O-ring.
10. Clean the check port with a clean dry rag. Assemble the components in the order shown.
11. Apply Loctite 242 on the valve stem's threads. Push down, compressing the spring, and thread the valve stem into the housing. Tighten to 110 in-lbs (12.4 Nm) using a spanner wrench or 5 mm Allen wrench.
12. After the procedure is complete, resume normal operation.

6. Serviceable Parts

Refer to *Section 8—Drawings*.

6.1 AL2 Tool Valve Serviceable Parts

Refer to *Section 8—Drawings* for serviceable items on the latest product versions. For the legacy product versions, refer to the following figure and table.

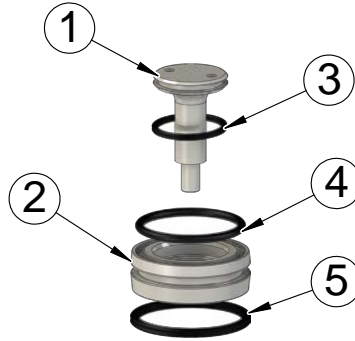

Table 6.1—AL2 Tool Valve Piston, Valve Stem, and Seals (Old Design)

Item No.	Qty	Part Number	Description
1	2	3700-20-9607	Tool Valve Stem
2	2	3700-20-6807	Tool 3/4" Valve Piston
3	2	3410-0001096-01 ¹	4 lobed, low friction seal, Buna N D70, 13/16" ID
4	2	3410-0001341-01 ¹	O-Ring, 1-3/16 ID x 3/32 W, AS568-123 Buna-N, D90
5	2	3410-0001099-01 ¹	4 lobed, low friction seal, Buna N D70, 1-5/16" ID

Notes:
 1. Seals are supplied in a kit 9121-AD2-T-Seal.

7. Specifications

Table 7.1—Master Module Specifications	
9121-AL2-M	Pneumatic Master module with (2) G 3/4 self-sealing ports
Materials of Construction:	Various - Stainless Steel valve components, aluminum housing, Buna-N seals
Self-Sealing Air Ports:	
Quantity	2
Air Pressure	Maximum pressure of 100 psi (6.9 bar)
Cv, Min	8.0 est.
Customer Port Connection	G 3/4
Weight:	2.7 lbs. (1.2 kg)

Table 7.2—Tool Module Specifications	
9121-AL2-T	Pneumatic Tool module with (2) G 3/4 self-sealing port
Materials of Construction:	Various - aluminum housing
Self-Sealing Air Ports:	
Quantity	2
Air Pressure	Maximum pressure of 100 psi (6.9 bar)
Cv, Min	8.0 est.
Customer Port Connection	G 3/4
Weight:	2.3 lbs. (1.0 kg)

8. Drawings

8.1 AL2 Module Drawing

Notes:

1. Significant forces are encountered when using the AL2 Module. Assistance is required to overcome these forces when coupling the tool changer.
2. See Manual for replacement parts, including older valve designs which require a spanner wrench for Stem installation. New Stems install with a hex wrench.

AL2-M Serviceable Parts

ITEM NO.	QTY	PART NUMBER	DESCRIPTION
1	2	3410-0001097-01	Quad Ring, 1-1/16"ID
2	2	3410-0001098-01	Quad Ring, 1-3/8"ID
3	2	3610-2015100-20	Spring, 1.1 inch dia, 2.5" long, 10.8#/in SS
4	2	3690-2100001-20	Retaining Ring
5	2	3700-20-1551	Tool F/A Piston
6	2	3700-20-4301	Master Valve Stem

AL2-T Serviceable Parts

ITEM NO.	QTY	PART NUMBER	DESCRIPTION
1	2	3410-0001099-01	Quad-Ring 1-5/16"ID
2	2	3410-0001341-01	O-Ring, 1-3/16IDx3/32, AS568-123 Buna-N, D90
3	2	3410-0001450-01	O-Ring, AS568-116, Buna-N, A90
4	2	3610-2015001-20	Spring
5	2	3700-20-9609	3/4" Valve Stem, Tool, Conical Seal
6	2	3700-20-9610	3/4" Valve Piston, Tool, Conical Seal

Notes: UNLESS OTHERWISE SPECIFIED, DO NOT SCALE DRAWING. ALL DIMENSIONS ARE IN MILLIMETERS.

PROPERTY OF ATI INDUSTRIAL AUTOMATION, INC. NOT TO BE REPRODUCED IN ANY MANNER EXCEPT FOR GROUP OR UNIT FROM WHICH PURCHASED BY ATI.

ATI INDUSTRIAL AUTOMATION

1031 Goodworth Drive, Apex, NC 27539, USA
 Tel: +1 919.772.0115, Fax: +1 919.772.8259
 Email: info@ati-ia.com, www.ati-ia.com
 ISO 9001 Registered Company

AL2 Module Drawing

DRAWN BY: B. Digeso, 7/18/05
 CHECKED BY: R. Heavner 8/5/05

SCALE: 1:2
 SIZE: B
 DRAWING NUMBER: 9630-20-AL2

PROJECT #: 050607-1 SHEET 1 OF 1
 REVISION: 07