



Force/Torque (F/T) Manual

Introduction

This manual is a compilation of several modular manual sections for an F/T sensor system. The modular manual sections are in the following order and provide the following information:

A. Introduction

This section includes contact information to reach an ATI representative, general safety guidelines, and terms and conditions of sale. The ATI document number for this modular manual section is: 9620-05-A-Introduction.

A comprehensive glossary of terms is here: https://www.ati-ia.com/library/Glossary_of_Robotic_Terminology.aspx.

B. Sensor

This section contains information about the sensor mechanical body.

Content includes a product overview, installation instructions, operation information, preventative maintenance guidance, troubleshooting guidelines, and specifications.

The ATI document number for this modular manual section is: 9620-05-B-XX (XX = sensor model name).

C. Communication Interface Version

This section contains information about the electrical and software features of a specific communication interface version. Examples of communication interface versions are EtherCAT, Ethernet, and RS422. This section also includes cable information.

The ATI document number for this modular manual section is: 9620-05-C-XX (XX = communication interface version).

D. Custom Application

This section contains additional information needed for the sensor system to work within a custom application.

The ATI document number for this modular manual section is: 9620-05-D-XX (XX = custom application).

Engineered Products for Robotic Productivity

Pinnacle Park • 1031 Goodworth Drive • Apex, NC 27539 USA • Tel: +1.919.772.0115 • Fax: +1.919.772.8259 • www.ati-ia.com

A. Introduction

Please contact ATI Industrial Automation with any questions concerning a particular model.



WARNING: Only use ATI products for applications approved by the manufacturer. Using ATI products in applications other than what was intended by the manufacturer could result in damage to equipment and injury to personnel.



CAUTION: This manual describes the function, application, and safety considerations of this product. This manual must be read and understood before any attempt is made to install or operate the product, otherwise damage to the product or unsafe conditions may occur.

Information contained in this document is the property of ATI Industrial Automation, Inc. (ATI) and shall not be reproduced in whole or in part without prior written approval of ATI. The information herein is subject to change without notice. This manual is periodically revised to reflect and incorporate changes made to the product.

The information contained herein is confidential and reserved exclusively for the customers and authorized agents of ATI Industrial Automation and may not be divulged to any third party without prior written consent from ATI. No warranty including implied warranties is made with regard to accuracy of this document or fitness of this device for a particular application. ATI Industrial Automation shall not be liable for any errors contained in this document or for any incidental or consequential damages caused thereby. ATI Industrial Automation also reserves the right to make changes to this manual at any time without prior notice.

ATI assumes no responsibility for any errors or omissions in this document.

Copyright © (2022) by ATI Industrial Automation. All rights reserved.

Note:

Please read the manual before calling customer service, and have the following information available:

1. Serial number, for example: FT01234
2. Model, for example: Axia130-M125
3. Calibration, for example: SI-800-50 or SI-2000-125
4. Accurate and complete description of the question or concern
5. Computer and software information, for example: operating system, PC type, drivers, and application software

Be near the F/T system when calling (if possible).

Please contact an ATI representative for assistance, if needed:

Sale, Service and Information about ATI products:

ATI Industrial Automation

1031 Goodworth Drive

Apex, NC 27539 USA

www.ati-ia.com

Tel: +1.919.772.0115

Fax: +1.919.772.8259

Application Engineering

Tel: +1.919.772.0115, Extension 511

Fax: +1.919.772.8259

E-mail: ft.support@novanta.com

24/7 Support: +1 855 ATI-IA 00 (+1 855-284-4200)

1. Safety

The safety section describes general safety guidelines to be followed with this product, explanations of the notifications found in this manual, and safety precautions that apply to the product. Product specific notifications are imbedded within the sections of this manual (where they apply).

1.1 Explanation of Notifications

These notifications are used in all of ATI manuals and are not specific to this product. The user should heed all notifications from the robot manufacturer and/or the manufacturers of other components used in the installation.



DANGER: Notification of information or instructions that if not followed will result in death or serious injury. The notification provides information about the nature of the hazardous situation, the consequences of not avoiding the hazard, and the method for avoiding the situation.



WARNING: Notification of information or instructions that if not followed could result in death or serious injury. The notification provides information about the nature of the hazardous situation, the consequences of not avoiding the hazard, and the method for avoiding the situation.



CAUTION: Notification of information or instructions that if not followed could result in moderate injury or will cause damage to equipment. The notification provides information about the nature of the hazardous situation, the consequences of not avoiding the hazard, and the method for avoiding the situation.

NOTICE: Notification of specific information or instructions about maintaining, operating, installing, or setting up the product that if not followed could result in damage to equipment. The notification can emphasize, but is not limited to: specific grease types, best operating practices, and maintenance tips.

1.2 General Safety Guidelines

The customer should verify that the sensor selected is rated for maximum loads and torques expected during operation. Because static forces are less than the dynamic forces from the acceleration or deceleration of the robot, be aware of the dynamic loads caused by the robot.

2. Terms and Conditions of Sale

The following Terms and Conditions are a supplement to and include a portion of ATI's Standard Terms and Conditions, which are on file at ATI and available upon request.

ATI warrants to Purchaser that robotic Tool Changer products purchased hereunder will be free from defects in material and workmanship under normal use for a period of three (3) years from the date of shipment. The warranty period for repairs made under a Return Merchandise Authorization (RMA) shall be for the duration of the original warranty, or ninety (90) days from the date of repaired product shipment, whichever is longer. ATI will have no liability under this warranty unless: (a) ATI is given written notice of the claimed defect and a description thereof within thirty (30) days after Purchaser discovers the defect and in any event not later than the last day of the warranty period; and (b) the defective item is received by ATI not later ten (10) days after the last day of the warranty period. ATI's entire liability and Purchaser's sole remedy under this warranty is limited to repair or replacement, at ATI's election, of the defective part or item or, at ATI's election, refund of the price paid for the item. The foregoing warranty does not apply to any defect or failure resulting from improper installation, operation, maintenance or repair by anyone other than ATI.

ATI will in no event be liable for incidental, consequential or special damages of any kind, even if ATI has been advised of the possibility of such damages. ATI's aggregate liability will in no event exceed the amount paid by Purchaser for the item which is the subject of claim or dispute. ATI will have no liability of any kind for failure of any equipment or other items not supplied by ATI.

No action against ATI, regardless of form, arising out of or in any way connected with products or services supplied hereunder may be brought more than one (1) year after the cause of action accrued.

No representation or agreement varying or extending the warranty and limitation of remedy provisions contained herein is authorized by ATI, and may not be relied upon as having been authorized by ATI, unless in writing and signed by an executive officer of ATI.

Unless otherwise agreed in writing by ATI, all designs, drawings, data, inventions, software and other technology made or developed by ATI in the course of providing products and services hereunder, and all rights therein under any patent, copyright or other law protecting intellectual property, shall be and remain ATI's property. The sale of products or services hereunder does not convey any express or implied license under any patent, copyright or other intellectual property right owned or controlled by ATI, whether relating to the products sold or any other matter except for the license expressly granted below.

In the course of supplying products and services hereunder, ATI may provide or disclose to Purchaser confidential and proprietary information of ATI relating to the design, operation or other aspects of ATI's products. As between ATI and Purchaser, ownership of such information, including without limitation any computer software provided to Purchaser by ATI, shall remain in ATI and such information is licensed to Purchaser only for Purchaser's use in operating the products supplied by ATI hereunder in Purchaser's internal business operations.

Without ATI's prior written permission, Purchaser will not use such information for any other purpose or provide or otherwise make such information available to any third party. Purchaser agrees to take all reasonable precautions to prevent any unauthorized use or disclosure of such information.

Purchaser will not be liable hereunder with respect to disclosure or use of information which: (a) is in the public domain when received from ATI; (b) is thereafter published or otherwise enters the public domain through no fault of Purchaser; (c) is in Purchaser's possession prior to receipt from ATI; (d) is lawfully obtained by Purchaser from a third party entitled to disclose it; or (f) is required to be disclosed by judicial order or other governmental authority, provided that, with respect to such required disclosures, Purchaser gives ATI prior notice thereof and uses all legally available means to maintain the confidentiality of such information.



Axia90 F/T Sensor Manual



Document #: 9620-05-B-Axia90

Engineered Products for Robotic Productivity

Pinnacle Park • 1031 Goodworth Drive • Apex, NC 27539 • Tel:+1 919.772.0115 • Fax:+1 919.772.8259 • www.ati-ia.com

Foreword

Information contained in this document is the property of ATI Industrial Automation, Inc. and shall not be reproduced in whole or in part without prior written approval of ATI Industrial Automation, Inc. The information herein is subject to change without notice and should not be construed as a commitment on the part of ATI Industrial Automation, Inc. This manual is periodically revised to reflect and incorporate changes made to the F/T system.

ATI Industrial Automation, Inc. assumes no responsibility for any errors or omissions in this document.

Copyright © (2023) by ATI Industrial Automation, Inc., Apex, North Carolina USA. All Rights Reserved.
Published in the USA.

ATI F/T Sensing Systems are considered components/ semi-finished goods intended for use in larger system/ device/ finished good.

In consideration that ATI Industrial Automation, Inc. (ATI) products are intended for use with robotic and/or automated machines, ATI does not recommend the use of its products for applications wherein failure or malfunction of a ATI component or system threatens life or makes injury probable. Anyone who uses or incorporates ATI components within any potentially life threatening system must obtain ATI's prior consent based upon assurance to ATI that a malfunction of ATI's component does not pose direct or indirect threat of injury or death, and (even if such consent is given) shall indemnify ATI from any claim, loss, liability, and related expenses arising from any injury or death resulting from use of ATI components.

All trademarks belong to their respective owners.

Note:

Please read the manual before calling customer service, and have the following information available:

1. Serial number (e.g., FT01234)
2. Sensor model (e.g., Axia90-M50)
3. Calibration (e.g., US-15-50, SI-65-6, etc.)
4. Accurate and complete description of the question or problem
5. Computer and software information (operating system, PC type, drivers, application software, and other relevant information about the application's configuration)

Be near the F/T system when calling (if possible).

Please contact an ATI representative for assistance, if needed:

Sale, Service and Information about ATI products:

ATI Industrial Automation

1031 Goodworth Drive
Apex, NC 27539 USA
www.ati-ia.com
Tel: +1.919.772.0115
Fax: +1.919.772.8259

Application Engineering

Tel: +1.919.772.0115, Extension 511
Fax: +1.919.772.8259
E-mail: ft.support@novanta.com

24/7 Support: +1 855 ATI-IA 00 (+1 855-284-4200)

Table of Contents

Glossary	B-4
1. Safety	B-6
1.1 Explanation of Notifications.....	B-6
1.2 General Safety Guidelines.....	B-6
1.3 Safety Precautions.....	B-7
2. Product Overview	B-8
3. Installation	B-10
3.1 Interface Plates.....	B-10
3.2 Routing the Cable.....	B-12
3.3 Cable Kits.....	B-15
3.4 Install the Sensor	B-16
3.5 Remove the Sensor.....	B-18
3.6 Accuracy Check Procedure.....	B-19
3.7 Detecting Sensitivity Changes.....	B-20
4. Operation	B-21
4.1 Sensor Environment	B-21
4.2 Tool Transformation.....	B-22
4.2.1 Avoid Overloading the Sensor During Tool Transformation.....	B-24
4.2.2 Tool Transformation Functionality Through a Communication Interface	B-24
5. Maintenance	B-24
5.1 Periodic Inspection	B-24
5.2 Periodic Calibrating	B-24
6. Troubleshooting	B-25
6.1 Basic Guidance for Troubleshooting	B-26
7. Specifications	B-29
7.1 Environmental Conditions.....	B-29
7.2 Electrical Specifications	B-29
7.3 Calibration Range.....	B-29
7.4 Default Peak Values	B-29
8. Terms and Conditions of Sale	B-30

Glossary

Term	Definition
Bias	Biasing is useful for eliminating the effects of gravity (tool weight) or other acting forces. When the bias function is used, the software collects data for the forces and torques that are currently acting on the sensor and use these readings as a reference for future readings. Future readings will have this reference subtracted from them before they are transmitted. Bias may also be referred to as “zero out” or “tare” the sensor.
Calibration	Defines a specific measurement or sensing range for a given sensor. Calibration is also the process of measuring a transducer’s raw response to loads and creating data used in converting the response to forces and torques.
Complex Loading	Any load that is not purely in one axis.
Communication Interface Versions	The software standard that the customer device uses to apply features to the sensor and for the sensor to report data, for example: EtherCAT, RS422, and Ethernet.
Coordinate Frame	See Sensing Reference Frame Origin.
Data Rate	How fast data can be output over a network.
Force	A force is a push or pull action on an object caused by an interaction with another object. Force = mass x acceleration.
FS	Full-Scale, refers to the limits of a given calibration or sensing range.
F/T	Force/Torque.
F_{xy}	The resultant force vector comprised of components F_x and F_y .
Hysteresis	A source of measurement error caused by the residual effects of previously applied loads.
Interface Plate	A separate plate that attaches the sensor to another surface. Interface plates are often used if the bolt pattern on the sensor doesn’t match the bolt pattern on the robot arm or customer tooling. The interface plate has two bolt patterns, one on either side of the plate. One side is for the sensor. The other side is for the robot arm or customer tooling.
IP67	Ingress protection rating “67” designates protection against dust and submersion under 1 m of fresh water.
Master Device	A customer supplied device such as a personal computer, robot, or programmable logic controller (PLC) that is compatible a specific communication interface.
Measurement Uncertainty	Commonly referred to as “accuracy”, “measurement uncertainty” is the worst-case error between the measured value and the true load. The measurement uncertainty is specified as a percentage of the full-scale measurement range for a given sensor model and calibration size. This value takes into account multiple sources of error. The sensor’s calibration certificate lists the measurement uncertainty percentage. For more information, refer to <i>Section 2.2: Measurement Uncertainty</i> in the Frequently Asked Questions (FAQ) document located at: https://www.ati-ia.com/library/documents/FT_FAQ.pdf .
Mechanical Coupling	When an external object such as customer tooling or utilities contacts a sensor’s surface between the sensor’s mounting side and tool side.
Mounting Interface Plate	An interface plate that attaches the sensor to a fixed surface like a robot arm.
N/A	Not Applicable
Overload	The condition where more load is applied to the transducer than it can measure. This will result in saturation.

Term	Definition
P/N	Part Number
Power Cycle	When a user removes and then restores power to a device.
Resolution	The smallest change in load that can be measured. Resolution is usually much smaller than accuracy.
Sample Rate	How fast the ADCs are sampling inside the unit.
Saturation	The condition where the transducer or data acquisition hardware has a load or signal outside of its sensing range.
Sensing Reference Frame Origin	The point on the sensor from which all forces and torques are measured.
Sensor	The component that converts a detected load into electrical signals.
Sensor System (or configuration)	The entire assembly consisting of a sensor body and a system interface to translate force and torque signals into a specific communication interface/protocol.
Tool Interface Plate	An interface plate that attaches the customer's tooling to the tooling side (sensing side) of the sensor.
Torque	The application of a force through a lever or moment arm that causes something to want to turn. For example, a user applies torque to a screw to make it turn. Torque = force x moment arm length.
T_{xy}	The resultant torque vector comprised of components T_x and T_y .

1. Safety

The safety section describes general safety guidelines to be followed with this product, explanations of the notifications found in this manual, and safety precautions that apply to the product. Product specific notifications are imbedded within the sections of this manual (where they apply).

1.1 Explanation of Notifications

These notifications are used in all of ATI manuals and are not specific to this product. The user should heed all notifications from the robot manufacturer and/or the manufacturers of other components used in the installation.



DANGER: Notification of information or instructions that if not followed will result in death or serious injury. The notification provides information about the nature of the hazardous situation, the consequences of not avoiding the hazard, and the method for avoiding the situation.



WARNING: Notification of information or instructions that if not followed could result in death or serious injury. The notification provides information about the nature of the hazardous situation, the consequences of not avoiding the hazard, and the method for avoiding the situation.



CAUTION: Notification of information or instructions that if not followed could result in moderate injury or will cause damage to equipment. The notification provides information about the nature of the hazardous situation, the consequences of not avoiding the hazard, and the method for avoiding the situation.

NOTICE: Notification of specific information or instructions about maintaining, operating, installing, or setting up the product that if not followed could result in damage to equipment. The notification can emphasize, but is not limited to: specific grease types, best operating practices, and maintenance tips.

1.2 General Safety Guidelines

The customer should verify that the sensor is rated for the maximum load and torque expected during operation. Because static forces are less than the dynamic forces from the acceleration or deceleration of the robot, be aware of the dynamic loads caused by the robot.

1.3 Safety Precautions



CAUTION: Modifying or disassembly of the sensor could cause damage and void the warranty. Use the supplied mounting interface plate and the provided tool side mounting bolt pattern to mount the sensor to the robot and customer tooling to the sensor. For more information, refer to the customer drawings.



CAUTION: Probing openings in the sensor causes damage to the instrumentation. Avoid prying into the openings of the sensor.



CAUTION: Do not overload the sensor. Exceeding the single-axis overload values of the sensor causes irreparable damage.



CAUTION: The sensor should be protected from impact and shock loads that exceed rated ranges during transportation as the impacts can damage the sensor's performance. Refer to [Section 7—Specifications](#) for more information about rated ranges.

2. Product Overview

The Axia90 Force/Torque (F/T) sensor detects six components of force and torque ($F_x \setminus F_y \setminus F_z \setminus T_x \setminus T_y \setminus T_z$) that are applied to the tool side of the sensor. The sensor communicates this data to a device (such as a personal computer, robot, or PLC). The ATI Axia-series product line differs from the other (non-Axia) ATI F/T sensor models. Thus, the Axia sensors have different options and available features. The Axia-series force/torque sensors are available in several different payload and communication interface versions. For more information about the communication interface, refer to the applicable ATI Axia sensor manual in [Table 2.1](#).

The sensor's mounting side attaches to a rigid fixture or robot. The robot mounting side of the sensor has a 81.065 mm diameter bolt circle (BC) for (6) M4 socket head cap screws and (2) 3 mm slip-fit dowel pin holes. The tool side attaches to the customer tooling. The tool side has a 50 mm BC pattern with (7) M6 tapped holes, 6 mm slip-fit dowel pin hole, and a 31.5 mm recess. For more information on the mounting patterns, refer to the [ATI Axia90 sensor customer drawing](#). If the sensor does not have the same bolt pattern as the mounting or tool sides, use interface plates; refer to [Section 3.1—Interface Plates](#). The sensor is IP67 rated.

An M8 8-pin male connector is for power and communication. On the side of the sensor, LEDs indicate the sensor's operational state. For the connector pin assignments on the sensor and cables and more information about the LEDs, refer to the applicable ATI communication interface manual in [Table 2.1](#).

The ATI Axia90 sensor customer drawing is available on the ATI website: https://www.ati-ia.com/app_content/Documents/9630-05-0007.auto.pdf.

Figure 2.1—Axia90 F/T Sensor

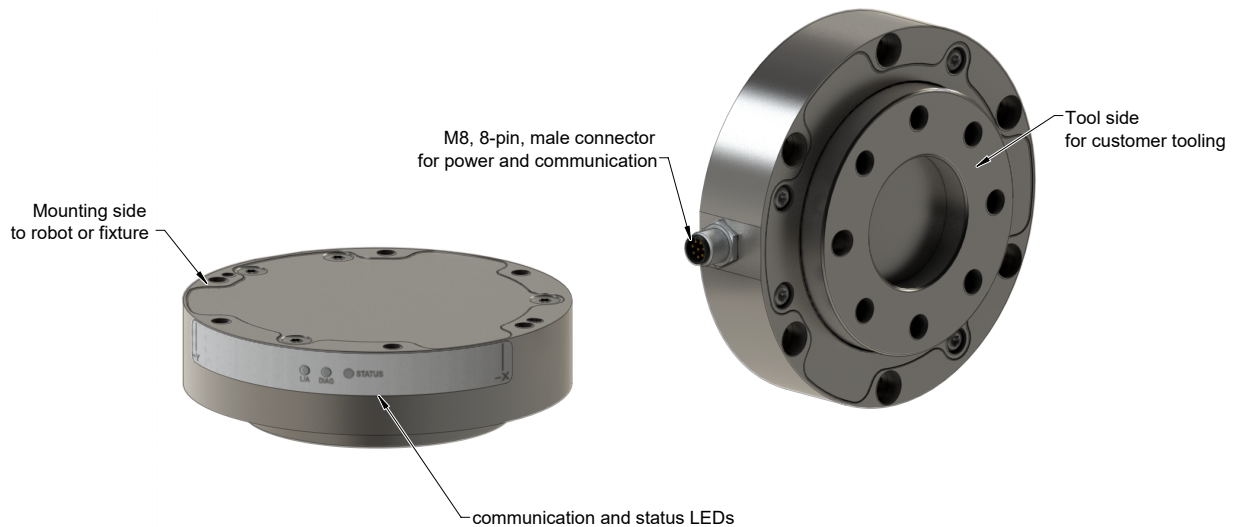

For more information on the electrical and software features of a specific communication interface version and the applicable cable, refer to the ATI manual in the following table:

Table 2.1—ATI Communication/Software Manual Reference			
Sensor Model ATI P/N	Communication Type	ATI Cable P/N	Refer to the ATI Manual
9105-NET- Axia90-M50	Ethernet	9105-C-ZC27-ZC28-4 ¹ 9105-C-ZC28-U-RJ45S-x	ATI F/T Ethernet Axia manual (ATI document # 9620-05-C-Ethernet Axia)
9105-ECAT- Axia90-M50	EtherCAT	9105-C-ZC27-ZC28-4 ¹ 9105-C-ZC28-U-RJ45S-x	ATI F/T EtherCAT Axia manual (ATI document # 9620-05-C-EtherCAT Axia)
9105-RS422- Axia90-M50	RS422	9105-C-ZC27-ZC28-4 ¹ 9105-C-ZC28-MS-ZC35-4 ²	ATI F/T RS422 Axia manual (ATI document # 9620-05-C-RS422 Axia)
Note: 1. Included in 9105-CKIT-ZC27-ZC28-X refer to Table 3.2 . 2. Customers must use either the 9105-C-ZC28-MS-ZC35-X DB9 serial cable or their own RS422 serial cable with a DB9 or USB connector to the ATI sensor cable. 3. This ATI manual references the Axia80 sensor, but the software interface concepts still apply to the Axia90 sensor.			

3. Installation



WARNING: Performing maintenance or repair on the sensor when circuits (for example: power, water, and air) are energized could result in death or serious injury. Discharge and verify all energized circuits are de-energized in accordance with the customer's safety practices and policies.



CAUTION: Using fasteners that exceed the customer interface depth penetrates the body of the sensor, damages the electronics, and voids the warranty. For more information, refer to the customer drawings.



CAUTION: Thread locker applied to fasteners must not be used more than once. Fasteners might become loose and cause equipment damage. Always apply new thread locker when reusing fasteners.



CAUTION: Avoid damage to the sensor from electrostatic discharge. Ensure proper grounding procedures are followed when handling the sensor or cables connected to the sensor. Failure to follow proper grounding procedures could damage the sensor.



CAUTION: Do not apply excessive force to the sensor and cable connector during installation, or damage will occur to the connectors. Align the keyway on the sensor and cable connector during installation to avoid applying excessive force to the connectors.



Keyway on the
sensor connector.

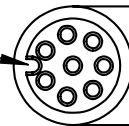

Keyway on the
cable connector.

3.1 Interface Plates

The sensor's mounting side attaches to a surface like the robot arm, and the sensor's tool side attaches to the customer tooling. The pattern on the Axia90 tool side is compatible with ISO 9409-1-50-4-M6 bolt pattern. Therefore, if customer tooling mounts to the sensor's tool side with a 50 mm bolt circle and (4) or (7) M6 bolts, an interface plate on the tool side of the sensor is not required. ATI can supply robot mounting kits that include a mounting interface plate and fasteners; for more information, contact ATI (refer to [page B-2](#)). If the customer chooses to supply their own interface plates, refer to the following design guidelines and the [ATI Axia sensor customer drawing](#).



CAUTION: Incorrect installation of interface plates can prevent the F/T sensor from functioning properly.

If the customer chooses to design and build an interface plate, consider the following points:

- The interface plate should include bolt holes for mounting fasteners as well as a dowel pin and boss for accurate positioning to the robot.
- The thickness of the interface plate must provide sufficient thread engagement for the mounting fasteners.
- The mounting fasteners should not interfere with the internal electronics of the sensor. For thread depth, mounting patterns, and other details, refer to the [ATI Axia sensor customer drawing](#).
- Do not use dowel pins that exceed length requirements and prevent interface plate from mating flush with the robot. Fasteners that exceed length requirements create a gap between the interfacing surfaces and cause damage.
- The interface plate must be as strong or stronger than the sensor so that maximum force and torque values applied to the sensor do not distort the interface plate. For these force and torque values, refer to [Section 7—Specifications](#).
- The interface plate must provide a flat and parallel mounting surface for the sensor.

Figure 3.1 —Interface Plate(s)

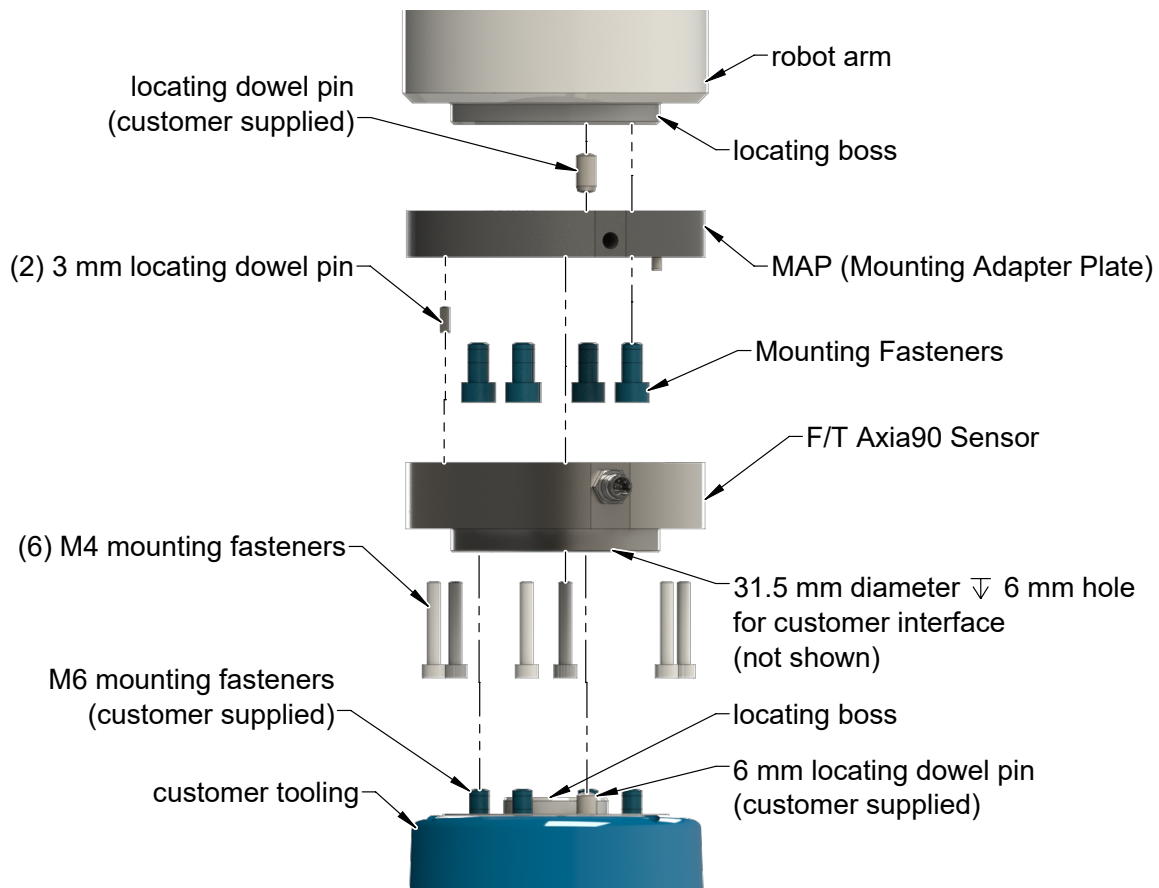

3.2 Routing the Cable

The routing and bending radius of the cable depends upon the customer application. Unlike motionless applications, where the cable is in a static condition, dynamic applications subject the cable to a repetitive motion. For dynamic applications, restrain the cable at a distance that does not expose and damage the sensor's cable connection from the robot's repetitive motion.

Figure 3.2—Routing of the Sensor Cable

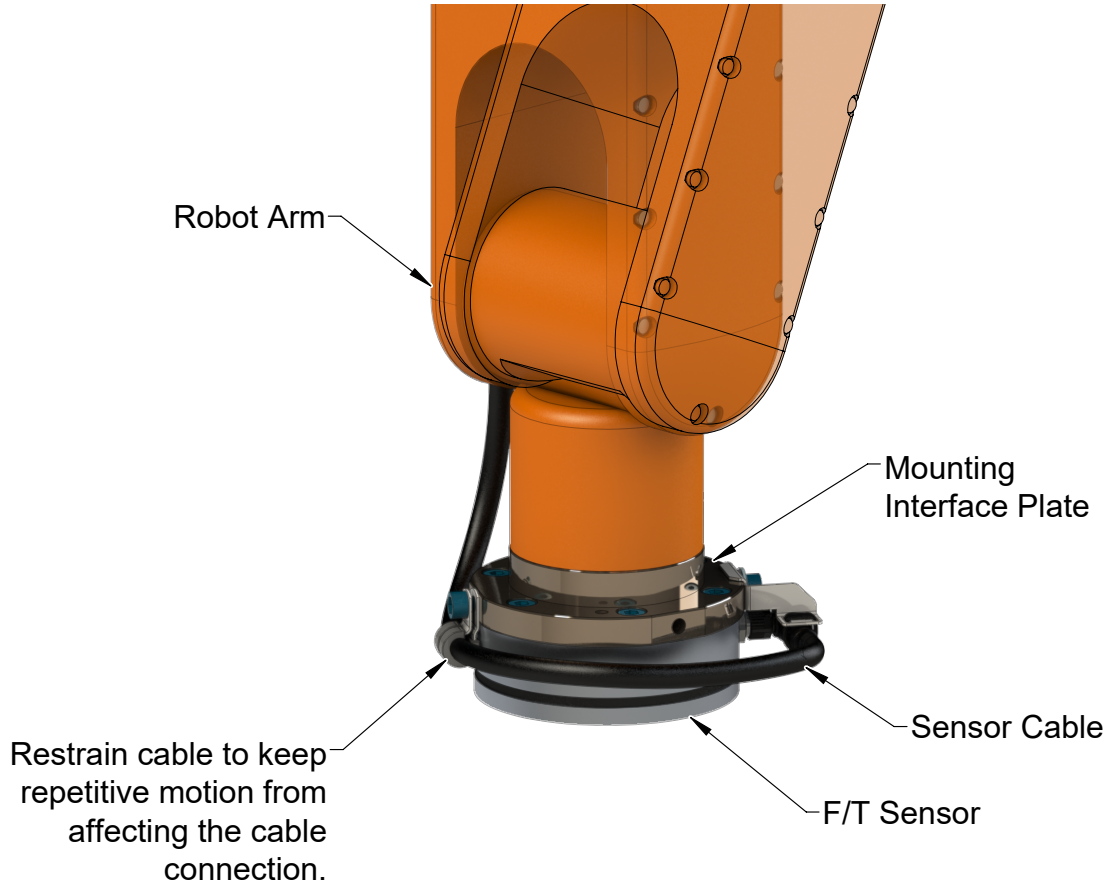

CAUTION: Subjecting the connector to the repetitive motion will cause damage to the connector. Restrain the cable close to the connector so that the repetitive motion of the robot does not interfere with the cable connector.



CAUTION: Improper cable routing may cause injury to personnel, poor functionality of critical electrical lines, or damage to the equipment. The electrical line, especially where attached to the sensor's connector, must be routed to avoid stress failure, sharp bends, or a disconnection from the equipment. Damage to the sensor or cable from improper routing will void the warranty.

For added stability, zip ties can be used to secure the cable to a mounting bracket (refer to the following figure). The zip ties should never contact the cable jacket.

Figure 3.3—Use Zip Ties on the Connector (sensor shown for reference only)

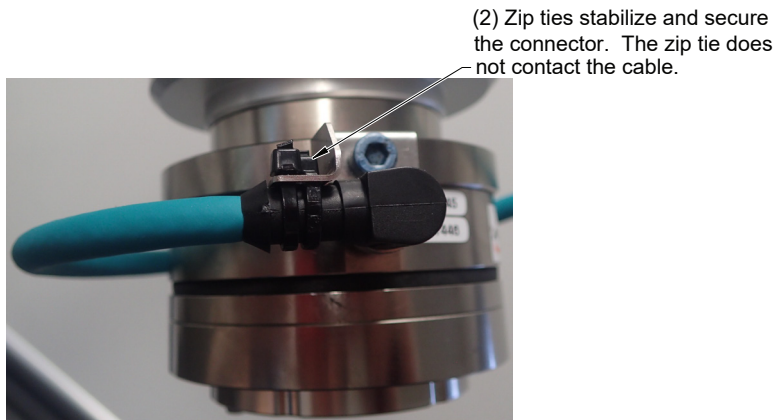

Route the sensor cable so that it is not stressed, pulled, kinked, cut, or otherwise damaged throughout the full range of motion. Use a robot dresspack solution, if possible. Examples of how to route the cable, if a dresspack is not available, are shown in the following figures and descriptions. Affix the cable by using hook and loop straps or Velcro® straps; do not use cable ties or zip ties.

Figure 3.4—Use Hook and Loop or Velcro® Straps on the Cable (sensor shown for reference only)

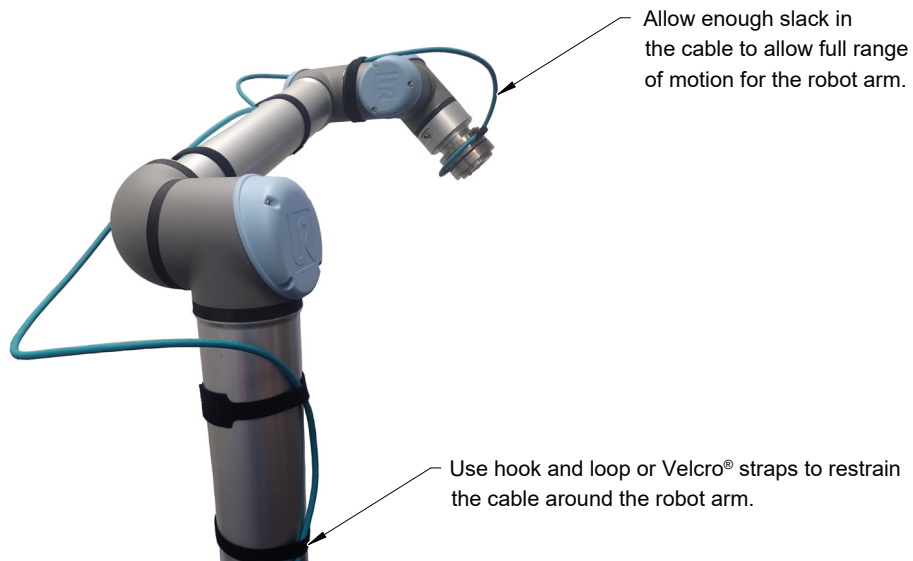

CAUTION: Do not use cable ties or zip ties to bundle cables or restrain the cable to the robot arm. Directly affixing cable ties or zip ties to the cable jacket will damage the cable. Use hook and loop or Velcro straps on the cable jacket surfaces. Examples of the incorrect and correct methods to restrain or bundle cables are in the following pictures:

INCORRECT

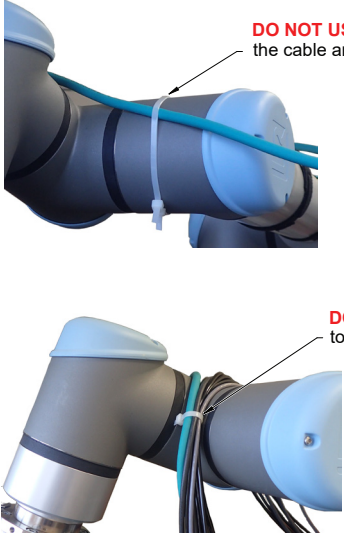

CORRECT

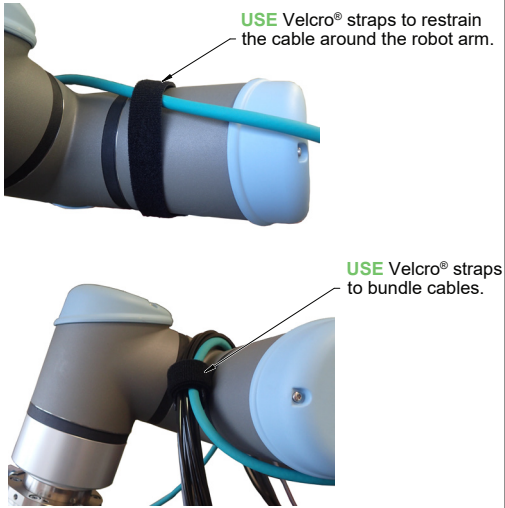

CAUTION: Do not damage or crush the cable by over tightening the straps on the cable.

CAUTION: When routing the cables, do not bend less than the minimum bending radius specified in [Table 3.1](#). A bend radius too small causes the cable to fail from fatigue of the robot’s repetitive motion.

Table 3.1—Sensor Cable Bending Radius and Dynamic Twist Angle

Cable Part Number	Cable Diameter mm (in)	Static Bending Radius (at room temperature)		Dynamic Bending Radius (at room temperature)		Dynamic Cable Twist Angle per Unit Length
		mm	in	mm	in	
9105-C-ZC27-ZC28-X ^{2,3}	6 (0.24)	25	1	50	2	180°/m or 55°/ft
9105-C-ZC28-U-RJ45S-X ²						

Notes:

- Temperature affects cable flexibility. ATI recommends increasing the minimum dynamic bending radius for lower temperatures.
- The X in the part number represents the cable length. For more information, contact ATI.
- Available in an ATI kit; refer to [Table 3.2](#).
- For information specific to the cable part number, refer to the applicable manual in [Table 2.1](#).

3.3 Cable Kits

For images of the sensor support bracket and P-clip, refer to [Figure 3.2](#) and [Figure 3.5](#).

Table 3.2—Cable Kit 9105-CKIT-ZC27-ZC28-X		
Part Number	Description	Quantity
9105-C-ZC27-ZC28-4	8-pin M12 connector to 8-pin M12 connector with a 4 m cable	1
9005-05-1078	(1) bracket, (1) M5 x 10 socket head cap screw, (1) M5 flat washer, and (1) tie	1
9005-05-1079	(1) P-clamp and (1) M5 x 10 socket head cap screw	1

3.4 Install the Sensor

Parts required: Refer to [Figure 3.5](#) and [ATI Axia sensor customer drawing](#)

Tools required: 3 mm and 4 mm hex key

Supplies required: Clean cloth, Loctite® 242

1. Clean the mounting surfaces.
2. Use the mounting fasteners to attach the interface plate to the mounting surface.

NOTICE: When installing an interface plate:

- Screws must have a minimum thread engagement length of 4.5 mm. Maximum screw thread engagement shall not exceed the threaded depth listed on the [ATI Axia sensor customer drawing](#).
- Unless otherwise specified, apply Loctite 242 to the (6) M4 socket head cap screws (class 12.9) so that the fasteners secure the sensor to the mounting plate.

3. Attach the mounting side of the sensor to the interface plate.
 - a. Secure the mounting side of the sensor to the interface plate with (6) M4 socket head cap screws (class 12.9). Use a 3 mm hex key to tighten the fasteners 45 in-lbs (5.08 Nm).
4. Once the sensor is installed on the robot, the customer tooling can be installed.

NOTICE: The tool must not touch any other part of the sensor except the tool side; otherwise, the sensor will not properly detect loads.

Figure 3.5—Installation of the Sensor to the Robot

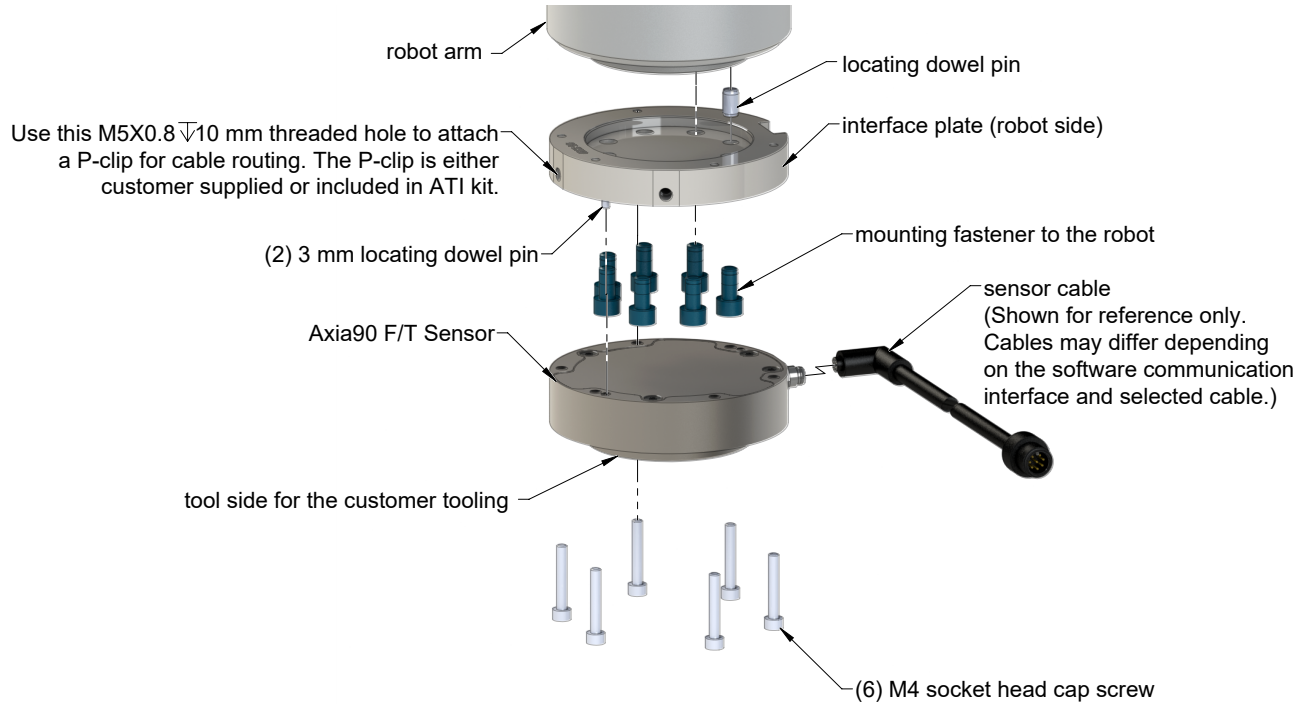

NOTICE: For the LED outputs that indicate the sensor's operational condition, refer to the applicable manual listed in [Table 2.1](#).

5. Connect the cable(s) to the sensor and customer application. For the sensor and cable connector pinout information, refer to the applicable manual in [Table 2.1](#).
6. After connecting the cable to the customer interface, set up the sensor communication interface software; for additional information about the software communication interface, refer to the applicable manual in [Table 2.1](#).
7. Properly restrain and route the cable (refer to [Section 3.2—Routing the Cable](#)). If using an ATI cable kit:
 - a. Above the sensor connector, secure the bracket to the interface plate. Insert the M5 screw through the flat washer. Use a 4 mm hex key to tighten the M5 socket head cap screw.
 - b. Use the tie in the kit to secure the connector to the bracket (refer to [Figure 3.3](#)).
 - c. Secure the P-clip to the interface plate (refer to [Figure 3.2](#)). Use a 4 mm hex key to tighten the M5 socket head cap screw.
 - d. Route the cable (refer to [Section 3.2—Routing the Cable](#)).
8. After installation is complete, the sensor is ready for an accuracy check (refer to [Section 3.6—Accuracy Check Procedure](#)).
9. Safely start normal operation.

3.5 Remove the Sensor

Tools required: 3 mm hex key

1. Turn off all energized circuits, for example: electrical.
2. Remove the cable from the sensor.
3. Supporting the customer tooling, remove the customer supplied screws that attach the customer tooling to the sensor.
4. Supporting the sensor, use a 3 mm hex key to remove the (6) M4 socket head cap screws that secure to the sensor to the mounting interface plate or surface.
5. Remove the sensor

3.6 Accuracy Check Procedure

Complete the following procedures after the initial installation of the sensor to the robot and once annually for maintenance.

NOTICE: The mass on the tool side can be the weight of the tooling used in the application.

1. Attach a fixed mass to the tool side of the F/T sensor:
 - a. Remove cables that form bridges between the sensor's mounting and tool sides.
2. Power on the sensor. Allow a 30 minute warm-up time. Minimize external sources of temperature change.

NOTICE: For optimal results, write a robot program to move the sensor and mass to each of the following positions sequentially. At each position, the robot should pause to record the sensor's output. Avoid jogging the robot and waiting several minutes between each position.

3. Move the robot so that the sensor is in the following positions:
 - a. Record the sensor's output, $F_{x, point n}$, $F_{y, point n}$, $F_{z, point n}$, at each point without biasing.
 - Point 1: +Z up
 - Point 2: +X up
 - Point 3: +Y up
 - Point 4: -X up
 - Point 5: -Y up
 - Point 6: -Z up
4. Calculate $F_{x, average}$, $F_{y, average}$, and $F_{z, average}$:
 - a. Use the following equations, to complete the calculations:

$$F_{x, average} = \frac{F_{x, point 1} + F_{x, point 2} + \dots + F_{x, point 6}}{6}$$

$$F_{y, average} = \frac{F_{y, point 1} + F_{y, point 2} + \dots + F_{y, point 6}}{6}$$

$$F_{z, average} = \frac{F_{z, point 1} + F_{z, point 2} + \dots + F_{z, point 6}}{6}$$

5. For each of the 6 points, complete the following calculation:

$$F_x = F_{x, point n} - F_{x, average}$$

$$F_y = F_{y, point n} - F_{y, average}$$

$$F_z = F_{z, point n} - F_{z, average}$$

$$\text{Tooling Mass} = \sqrt{F_x^2 + F_y^2 + F_z^2}$$

6. The calculated tooling masses for all (6) points should deviate from each other by less than twice the worst accuracy rating of the sensor.
 - For example: the Axia90-M50 sensor's rated accuracy is 2% the range on all axes. For a 1000 N F_{xy} range and a 2000 N F_z range, the allowable errors of any single data point would be ± 20 N F_{xy} and ± 40 N F_z respectively. Since F_z has the larger tolerance, then one data point could be + 40 N and another data point could be - 40 N, for a total range (max-min) of 80 N error.
 - In addition, the tooling mass should be within 80 N of the results of this test when it was performed with a new sensor.
7. If this test fails, then the sensor should be returned to ATI for diagnosis or recalibration.

3.7 Detecting Sensitivity Changes

Sensitivity checking of the sensor can also be used to measure the Axia sensor's health. Apply known loads to the sensor and verifying the system output matches the known loads. For example, a sensor mounted to a robot arm may have an end-effector attached to it. Use the following process to set a sensitivity value:

1. If the end-effector has moving parts, they must be moved in a known position.
 - a. Place the robot arm in an orientation that allows the gravity load from the end-effector to exert load on many sensor output axes.
2. Record the output readings.
3. Position the robot arm to apply another load, this time causing the outputs to move far from the earlier readings.
4. Record the second set of output readings.
5. Find the differences from the first and second set of readings.
6. Use the differences as a sensitivity value.

Even if the sensitivity values vary from sample set to sample set, these values can be used to detect gross errors. Either the resolved outputs or the raw sensor voltages may be used (the same must be used for all steps of this process).

4. Operation

Information that applies generally to all Axia90 sensors is in the following section. For more information specific to the communication protocol of the sensor, such as sampling rate, LEDs, operation commands, refer to the applicable manual in [Table 2.1](#).

4.1 Sensor Environment



CAUTION: Damage to the outer jacketing of the sensor cable could enable moisture or water to enter an otherwise sealed sensor. Ensure the cable jacketing has not deteriorated to prevent sensor damage.

NOTICE: Sensors may react to exceptionally strong and changing electromagnetic fields, such as those fields created by magnetic resonance imaging (MRI) machines.

The user must ensure that the water in the environment does not exceed the IP67 rating of the sensor. With an IP67 rating, the sensor is dustproof and water resistant up to 1 m of submersion in fresh water for up to 30 minutes as well as when exposed to high pressure spray. While the Axia90 sensor is IP67 rated, keep debris and dust from accumulating on or in the sensor.

4.2 Tool Transformation

By default, the forces and torques are reported with respect to a point of origin on the sensor that is set by ATI. For the sensor's point of origin, refer to the [ATI Axia sensor customer drawing](#). The tool transformation function allows measurement of the forces and torques at a reference point other than the sensor's point of origin.



CAUTION: If the customer sets a reference point that is at the same location to which a force is applied, there will be no report of a torque applied to the sensor. As a result, the sensor could be overloaded (refer to [Section 4.2.1—Avoid Overloading the Sensor During Tool Transformation](#)). Therefore, when evaluating overloading conditions, use the sensor's point of origin as the reference point.

The user defines a reference point by inputting a parameter set that is a series of (3) displacements ($D_x \setminus D_y \setminus D_z$) and (3) rotations ($R_x \setminus R_y \setminus R_z$), for example:

$D_x = -97.3 \text{ mm}$ $D_y = 46.1 \text{ mm}$ $D_z = 201.82 \text{ mm}$ $R_x = +90^\circ \text{ rotation}$ $R_y = +180^\circ \text{ rotation}$ $R_z = 0^\circ \text{ rotation}$

If zeros are entered for any of the parameter set values, the tool transformation is not performed for that particular parameter. Entering zero for all of the parameters, turns the tool transformation feature off. Once a new parameter set is entered and saved, previously entered parameter sets are no longer in effect.

Once a user enters a parameter set, the displacements are performed first. The displacements of the user reference frame of origin from the sensor point of origin is shown in the following figure. In this figure, the user reference frame of origin has not yet rotated relative to the sensor point of origin.

NOTICE: In the following figures, the sensor model is shown for reference only. The connector and sensor axes may align differently between sensor models. To determine the location of the default sensor axes, refer to the ATI sensor drawing or the axes labels on the sensor.

Figure 4.1—Tool Transformation : Distances
(sensor shown for reference only)

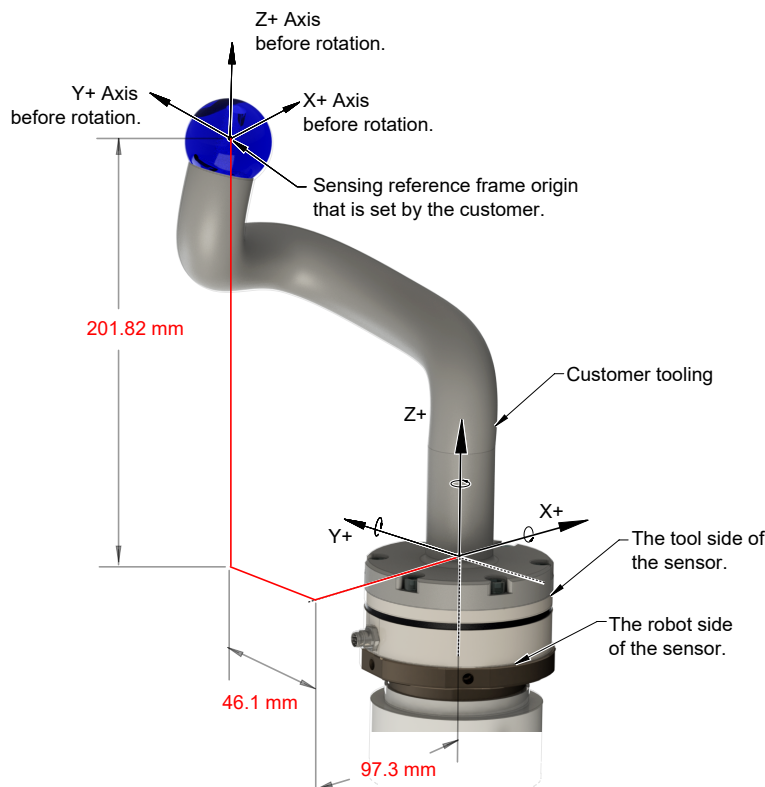

After the displacements, the user point of origin rotates in the following order:

1. The first rotation is about the X-axis.
 - Recall in this example $R_x = +90^\circ$ rotation. The user point of origin rotates $+90^\circ$ about the X-axis, in the following figure.

**Figure 4.2—Tool Transformation : Rotation About the X-Axis
(sensor shown for reference only)**

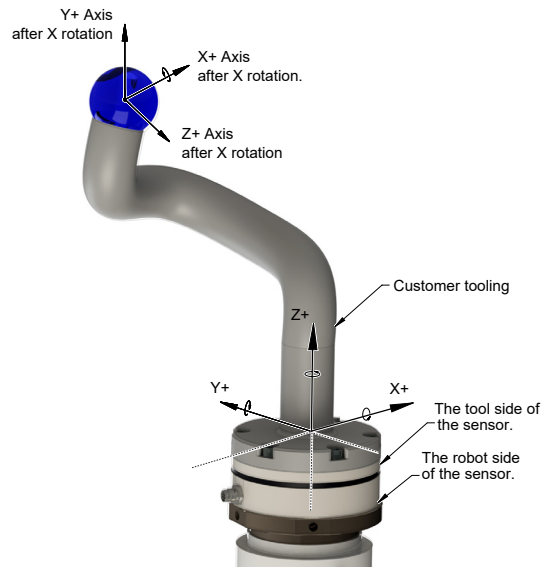

2. The second rotation is about the Y-axis of the new user output reference frame.
 - In this example $R_y = +180^\circ$ rotation. The user point of origin rotates $+180^\circ$ about the Y-axis of the new user output reference frame, in the following figure.

**Figure 4.3—Tool Transformation: Rotation About the Y-Axis
(sensor shown for reference only)**

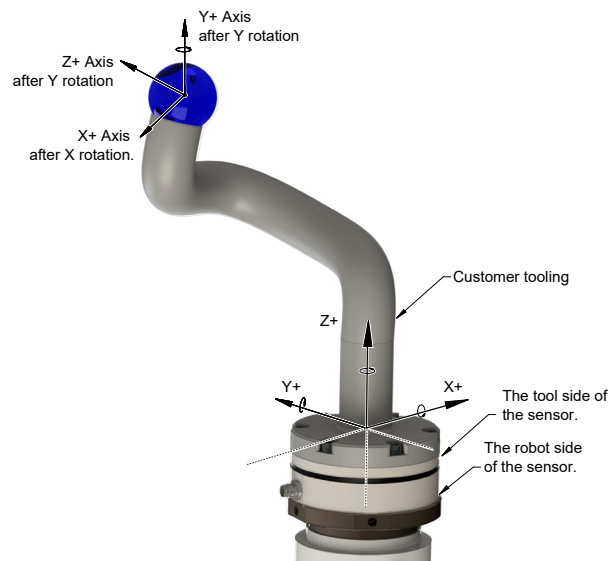

3. The third and final rotation is about the Z-axis of the new user output reference frame.
 - In this example $R_z = 0^\circ$ rotation. Therefore, the user point of origin does not rotate any more.
- After, the rotations are complete, the final user reference frame of origin is set.

4.2.1 Avoid Overloading the Sensor During Tool Transformation

It is possible for the user to set a reference point of origin that does not detect that a torque is applied to the customer tooling, and by extension, the sensor. Torque is the force multiplied by the distance of that force from a reference point of origin. If the customer reference point of origin is at the same point at which a force is applied, the distance from that force to the customer reference point of origin is zero. Any force that is multiplied by a distance of zero yields zero torque. The software tool transformation reports that no torque is applied to the sensor. However, the sensor's point of origin has not changed, and the force is still applied at a distance from the sensor's point of origin. Therefore, if the customer is evaluating overloading conditions, the customer should use the sensor's point of origin as the reference point.

4.2.2 Tool Transformation Functionality Through a Communication Interface

The user defines a reference point by inputting a parameter set that is a series of (3) displacements ($D_x \setminus D_y \setminus D_z$) and (3) rotations ($R_x \setminus R_y \setminus R_z$). For commands that write a parameter set and units, refer to the appropriate manual in [Table 2.1](#).

5. Maintenance

5.1 Periodic Inspection

With industrial-type applications that frequently move the system's cabling, inspect the cable jacket for signs of wear. While the Axia sensor is IP67 rated, keep debris and dust from accumulating on or in the sensor. Clean the surface of the sensor with isopropyl alcohol.

5.2 Periodic Calibrating

Periodic calibration of the sensor and its electronics is required to maintain traceability to national standards. The sensor cannot be calibrated in the field; return the sensor to ATI for recalibration. Contact an ATI account manager or rma-admin@ati-ia.com to request a Returned Materials Authorization (RMA) for recalibration. ATI recommends annual accuracy checks (refer to [Section 3.6—Accuracy Check Procedure](#)). If the sensor does not meet the performance requirements of the user application and fails the accuracy check, return the sensor to ATI for recalibration.

6. Troubleshooting

This section includes solutions to some issues that might arise when setting-up and using the sensor. For questions and troubleshooting assistance with software, refer to the appropriate manual in [Table 2.1](#). Answers to frequently asked questions are available from the ATI website: https://www.ati-ia.com/library/documents/FT_FAQ.pdf.

The information in this section should answer many questions that might arise in the field. Customer service is available to users who have questions or concerns addressed in the manuals.

Note

Please read the manual before calling customer service. Before calling, have the following information available:

1. Serial number (e.g., FT01234)
2. Sensor model (e.g., Axia90-M50)
3. Calibration (e.g., US-15-50, SI-65-6, etc.)
4. Accurate and complete description of the question or problem
5. Computer and software information (operating system, PC type, drivers, application software, and other relevant information about the application's configuration)

If possible, be near the F/T system when calling.

For additional troubleshooting information or to speak with a customer service representative, please contact ATI at:

ATI Industrial Automation

1031 Goodworth Drive
Apex, NC 27539 USA
www.ati-ia.com

Application Engineering

Tel: +1.919.772.0115, Extension 511
Fax: +1.919.772.8259
E-mail: ft.support@novanta.com
24/7 Support: +1 855 ATI-IA 00 (+1 855-284-4200)

6.1 Basic Guidance for Troubleshooting

Basic symptoms of inaccurate data and errors are listed in the following section. For each symptom, causes and appropriate solutions are suggested.

Symptom: Noise — jumps in force torque readings greater than 0.05% of full-scale counts.

Cause: Noise can be caused by mechanical vibrations and electrical disturbances that are possibly from a poor ground. Electrical interference can also come from a high noise output device such as a motor.

Solution: Make sure that the DC supply voltage for the Axia sensor has little to no noise superimposed. Ground the sensor by connecting the cable's shield to ground. In most setups, 0 V is also connected to ground. Connect the robot or other fixture to the same ground.

Verify that sensor cables do not cross over other cables or are within close proximity to other equipment that could generate electrical noise.

Avoid sources of mechanical noise. If not possible, apply a filter to the data as described in the applicable communication interface ATI manual in [Table 2.1](#).

Cause: Noise can also indicate component failure within the system.

Solution: Check the status code of the sensor; refer to the applicable communication interface ATI manual in [Table 2.1](#).

Perform an accuracy check; refer to [Section 3.6—Accuracy Check Procedure](#) or refer to [Section 4.5: How do I evaluate the accuracy of health of the sensor?](#) in the Frequently Asked Questions (FAQ) ATI document located at: https://www.ati-ia.com/library/documents/FT_FAQ.pdf.

To return the sensor to ATI for inspection, contact ATI for a Returned Materials Authorization (RMA); refer to [Section 5.2—Periodic Calibrating](#).

Symptom: Drift — when the force torque data continues to increase or decrease after a load is removed.

Cause: Some drift from a change in temperature is normal. Drift is observed more easily in the Z axis, compared to the X and Y axes.

Solution: For approximately thirty minutes, allow the sensor to warm up until it is at a steady state with the air and other objects touching the sensor.

Use the bias command to shift the readings back to zero. Bias regularly.

Use an insulator between the sensor and any tooling or fixtures which are at a different temperature. Avoid creating a temperature gradient across the sensor. Shield the sensor from excessive air flow.

For more information about how to avoid drift from temperature change, refer to the following ATI document: <https://www.ati-ia.com/Library/Documents/DriftExplanation.pdf>.

Symptom: Hysteresis — when the sensor is loaded from a zeroed or biased state and then the load is removed, sensor output does not immediately return to zero.

Cause: Mechanical coupling or internal failure can cause Hysteresis which is outside of the sensor's specified and acceptable measurement uncertainty (error) range.

Solution: Verify the sensor is properly installed, fasteners are tightened, and the customer tooling is securely installed per [Section 3—Installation](#).

Use the bias command to shift the readings back to zero.

Symptom: The initial F/T values are non-zero and no load is applied.

Normal. Bias the sensor to bring all the F/T values back to zero.

Symptom: The sensor does not report accurate F/T data.

Cause: The sensor may be in an error state.

Solution: Check the sensor status code. For how to read and interpret the status code, refer to the appropriate manual in [Table 2.1](#)). If there are no error bits ON, continue troubleshooting.

Cause: The sensor is not properly installed or not mounted to a flat, stiff surface.

Solution: Verify the sensor is correctly installed per [Section 3—Installation](#).

Cause: The mounting fasteners are not properly secured.

Solution: Verify the fasteners are secured per the installation procedures in [Section 3.4—Install the Sensor](#).

If fasteners are customer supplied, do not use fasteners that are too long. For maximum fastener penetration depth into the sensor, refer to the [ATI sensor drawing](#). When selecting fasteners: use a high quality, high strength screw or bolt and ensure the fastener's material type, fastener head, and fastener grade are proper for the application.

Cause: Mechanical coupling — an external object such as customer tooling or utilities contacts a sensor's surface between the mounting side and tool side.

Solution: Remove any debris between the tool side and interface plate. Use proper cable management for cables and hoses; do not connect them tightly between the mounting and tool side of the sensor.

Anything that contacts surfaces such as the through hole in the sensor or cover plates on either side of the sensor induces loading or movement that could result in inaccurate F/T data.

Symptom: The F/T values do not match expected values, for example: the F/T values are fluctuating but are higher than a known applied load.

Cause: The sensor may be in a mode that reports gage data instead of F/T data.

Solution: Gage data is not a 1:1 correlation to F/T axis data. View F/T data instead of gage data; refer to the applicable communication interface ATI manual in [Table 2.1](#).

Cause: The sensor outputs data in counts. The user must convert the counts to calibration units.

Solution: Counts must be divided by the Counts per Force (CpF) or Counts per Torque (CpT) in order to convert them to calibration units such as N and Nm.

In addition to CpF and CpT, depending on the communication protocol, the values may be further scaled by a 16-bit scale factor. 16-bit counts must be divided by (CpF or CpT ÷ 16-bit scale factor) in order to convert to calibration units.

Cause: If once the F/T readings are converted to calibration units and exceed the sensor's calibration range per [Section 7.3—Calibration Range](#), the reported values are inaccurate and the sensor may be overloaded.

Solution: Check the status code. For information on how to read and interpret the sensor's status code, refer to the applicable communication interface ATI manual in [Table 2.1](#).

Unmount the sensor. Improper mounting methods can induce high loads in the sensor.

After reinstalling the sensor and without applying a load, if errors such as "Sensing Range Exceeded", "Gage Out of Range", or "Gage Broken" persist, the sensor is likely permanently damaged due to overload.

7. Specifications

Some requirements and specifications for the Axia90 sensor are covered in the following sections. For more information, refer to the customer drawing.

7.1 Environmental Conditions

Table 6.1—Environmental Conditions	
Parameter	Value
Storage Temperature, °C	-20 to +85
Operating Temperature, °C	0 to +65
Relative Humidity	<95%, non-condensing

7.2 Electrical Specifications

Table 6.2—Power Supply ¹				
Power Source	Voltage			Power Consumption
	Minimum	Nominal	Maximum	Maximum
DC Power	12 V	24 V	30 V	1.5 W

Notes:

- The power supply input is reverse polarity protected. If the power and ground to the power supply inputs are plugged in reverse, then the reverse polarity protection stops the incorrectly wired supply input from damaging or powering on the sensor.

7.3 Calibration Range

Table 6.3—Calibration Range			
Model	Axia90-M50		
Parameter	Fxy	Fz	Txyz
Calibration Range 0 (SI-1000-50)	1000 N	2000 N	50 Nm

7.4 Default Peak Values

When powered on, the sensor records the peak values seen on any single axis. The following values are the default values programmed at the factory during calibration. If the sensor shows peak values higher than these defaults, the sensor has been loaded past the intended calibrated sensing range.

Table 6.4—Default Peak Values in Counts						
Sensor Model	Axia90-M50					
Parameter	Fx	Fy	Fz	Tx	Ty	Tz
Positive Default Value	6.24999 x 10 ⁸		1.249998 x 10 ⁹			3.124995 x 10 ⁷
Negative Default Value	-6.24999 x 10 ⁸		-1.249998 x 10 ⁹			-3.124995 x 10 ⁷

8. Terms and Conditions of Sale

The following Terms and Conditions are a supplement to and include a portion of ATI's Standard Terms and Conditions, which are on file at ATI and available upon request.

ATI warrants to Purchaser that force torque sensor products purchased hereunder will be free from defects in material and workmanship under normal use for a period of one (1) year from the date of shipment. The warranty period for repairs made under a RMA shall be for the duration of the original warranty, or ninety (90) days from the date of repaired product shipment, whichever is longer. ATI will have no liability under this warranty unless: (a) ATI is given written notice of the claimed defect and a description thereof with thirty (30) days after Purchaser discovers the defect and in any event, not later than the last day of the warranty period and (b) the defective item is received by ATI not later than (10) days after the last day of the warranty period. ATI's entire liability and Purchaser's sole remedy under this warranty is limited to repair or replacement, at ATI's election, of the defective part or item or, at ATI's election, refund of the price paid for the item. The foregoing warranty does not apply to any defect or failure resulting from improper installation, operation, maintenance, or repair by anyone other than ATI.

ATI will in no event be liable for incidental, consequential, or special damages of any kind, even if ATI has been advised of the possibility of such damages. ATI's aggregate liability will in no event exceed the amount paid by the purchaser for the item which is the subject of claim or dispute. ATI will have no liability of any kind for failure of any equipment or other items not supplied by ATI.

No action against ATI, regardless of form, arising out of or in any way connected with products or services supplied hereunder, may be brought more than one year after the cause of action accrued.

No representation or agreement varying or extending the warranty and limitation of remedy provisions contained herein is authorized by ATI, and may not be relied upon as having been authorized by ATI, unless in writing and signed by an executive officer of ATI.

Unless otherwise agreed in writing by ATI, all designs, drawings, data, inventions, software, and other technology made or developed by ATI in the course of providing products and services hereunder, and all rights therein under any patent, copyright, or other law protecting intellectual property, shall be and remain ATI's property. The sale of products or services hereunder does not convey any expressed or implied license under any patent, copyright, or other intellectual property right owned or controlled by ATI, whether relating to the products sold or any other matter, except for the license expressly granted below.

In the course of supplying products and services hereunder, ATI may provide or disclose to Purchaser confidential and proprietary information of ATI relating to the design, operation, or other aspects of ATI's products. As between ATI and Purchaser, ownership of such information, including without limitation any computer software provided to Purchaser by ATI, shall remain in ATI and such information is licensed to Purchaser only for Purchaser's use in operating the products supplied by ATI hereunder in Purchaser's internal business operations.

Without ATI's prior written permission, Purchaser will not use such information for any other purpose or provide or otherwise make such information available to any third party. Purchaser agrees to take all reasonable precautions to prevent any unauthorized use or disclosure of such information.

Purchaser will not be liable hereunder with respect to disclosure or use of information which: (a) is in the public domain when received from ATI, (b) is thereafter published or otherwise enters the public domain through no fault of Purchaser, (c) is in Purchaser's possession prior to receipt from ATI, (d) is lawfully obtained by Purchaser from a third party entitled to disclose it, or (f) is required to be disclosed by judicial order or other governmental authority, provided that, with respect to such to maintain the confidentiality of such information.



Ethernet Axia Manual

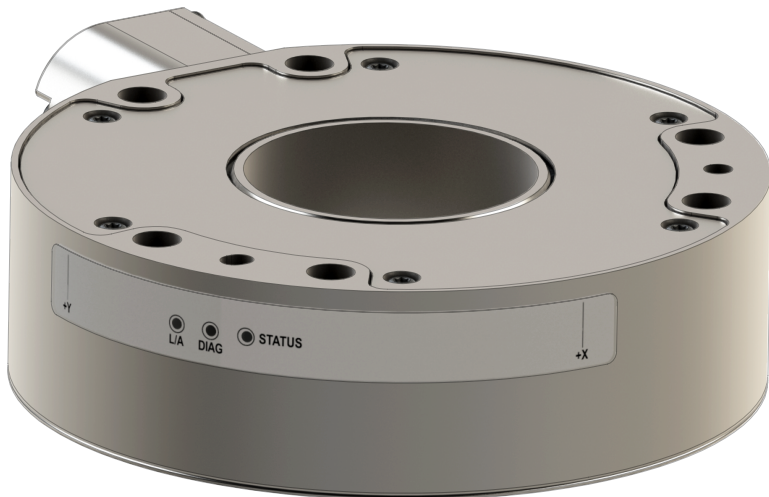

Document #: 9620-05-C-Ethernet Axia

Engineered Products for Robotic Productivity

Pinnacle Park • 1031 Goodworth Drive • Apex, NC 27539 • Tel:+1 919.772.0115 • Fax:+1 919.772.8259 • www.ati-ia.com

Foreword

Information contained in this document is the property of ATI Industrial Automation, Inc. and shall not be reproduced in whole or in part without prior written approval of ATI Industrial Automation, Inc. The information herein is subject to change without notice and should not be construed as a commitment on the part of ATI Industrial Automation, Inc. This manual is periodically revised to reflect and incorporate changes made to the F/T system.

ATI Industrial Automation, Inc. assumes no responsibility for any errors or omissions in this document.

Copyright© (2022) by ATI Industrial Automation, Inc., Apex, North Carolina USA. All Rights Reserved.
Published in the USA.

ATI F/T Sensing Systems are considered components/ semi-finished goods intended for use in larger system/
device/ finished good.

In consideration that ATI Industrial Automation, Inc. (ATI) products are intended for use with robotic and/or automated machines, ATI does not recommend the use of its products for applications wherein failure or malfunction of a ATI component or system threatens life or makes injury probable. Anyone who uses or incorporates ATI components within any potentially life threatening system must obtain ATI's prior consent based upon assurance to ATI that a malfunction of ATI's component does not pose direct or indirect threat of injury or death, and (even if such consent is given) shall indemnify ATI from any claim, loss, liability, and related expenses arising from any injury or death resulting from use of ATI components.

All trademarks belong to their respective owners. Windows® is a registered trademark of Microsoft Corporation.

Note:

Please read the manual before calling customer service, and have the following information available:

1. Serial number (e.g., FT01234)
2. Sensor model (e.g., Axia90-M50)
3. Calibration (e.g., US-15-50, SI-65-6, etc.)
4. Accurate and complete description of the question or problem
 - For the status code bit map; refer to [Section 5.5—Status Code](#).
 - For checking the system's status, issue a "Status" command (refer to [Table 8.1](#)) or view the System Information webpage (refer to [Section 6.8—System Information Page \(manuf.htm\)](#)).
5. Computer and software information (operating system, PC type, drivers, application software, and other relevant information about the application's configuration)

Be near the F/T system when calling (if possible).

Please contact an ATI representative for assistance, if needed:

Sale, Service and Information about ATI products:

ATI Industrial Automation

1031 Goodworth Drive
Apex, NC 27539 USA

www.ati-ia.com

Tel: +1.919.772.0115

Fax: +1.919.772.8259

Application Engineering

Tel: +1.919.772.0115, Extension 511

Fax: +1.919.772.8259

E-mail: ft_support@novanta.com

24/7 Support: +1 855 ATI-IA 00 (+1 855-284-4200)

Table of Contents

Glossary	C-7
1. Safety	C-10
1.1 Explanation of Notifications.....	C-10
1.2 General Safety Guidelines.....	C-10
1.3 Safety Precautions	C-11
2. Product Overview	C-12
3. Installation	C-13
3.1 Installation of the Sensor to the Robot	C-13
3.2 Cable Configuration.....	C-14
3.3 Pin and Wire Assignments for Connectors	C-14
3.3.1 Pin Assignment for the Axia F/T Sensor.....	C-15
3.3.1.1 Axia80 6-Pin M8 Male Connector	C-15
3.3.1.2 Axia80 and Axia90 8-pin M8 Male Connector.....	C-15
3.3.1.3 Axia130 8-pin M12 Male Connector	C-15
3.3.2 Axia80 Sensor Cable (P/N 9105-C-ZC22-ZC28-X).....	C-16
3.3.3 Axia80 and Axia90 Sensor Cable (P/N 9105-C-ZC27-ZC28-X).....	C-16
3.3.4 Axia130 Sensor Cable (P/N 9105-C-ZC28-ZC28-X).....	C-17
3.3.5 Ethernet Cable (P/N 9105-C-ZC28-U-RJ45S-X).....	C-18
4. Connecting Through Ethernet	C-19
4.1 IP Address Configuration for Ethernet.....	C-19
4.2 Connecting To the ATI Webpages Using a Windows Computer	C-20
4.3 Finding the Ethernet Axia Sensor on a Network	C-23
5. Operation	C-25
5.1 LED Self-Test Sequence	C-25
5.2 LED Normal Operation.....	C-26
5.2.1 Sensor Status LED.....	C-26
5.2.2 Diag LED	C-26
5.2.3 Ethernet Link/Activity LED.....	C-26
5.3 Sample Rate.....	C-27
5.3.1 Sample Rate Versus Data Rate	C-27
5.4 Low-Pass Filter.....	C-27
5.5 Status Code	C-31
5.5.1 Status Code: Sensing Range Exceeded	C-32
6. ATI Ethernet Axia Webpages Interface	C-34
6.1 Welcome Page (index.htm).....	C-34
6.2 Snapshot Page (rundata.htm)	C-35

6.3	Demo Page (demo.htm)	C-36
6.4	ADC Settings Page (setting.htm)	C-36
6.5	Thresholding Page (moncon.htm)	C-37
6.6	F/T Configurations Page (config.htm)	C-41
6.7	Communication Page (comm.htm)	C-42
6.8	System Information Page (manuf.htm)	C-44
6.9	Status Log Page (status.htm).....	C-45
6.10	Interface Example Page (examples.htm).....	C-46
6.11	ATI Website Menu Item	C-47
7.	Java® Demo Application	C-48
7.1	Starting the Demo	C-48
7.2	Data Display with the Demo	C-50
7.3	Collecting Data with the Demo.....	C-50
7.4	Demo CSV File Format.....	C-52
7.5	The Errors Field Display of the Demo	C-54
7.6	Developing a Customized Java® Application.....	C-54
8.	Console Interface Through Telnet	C-55
8.1	Setting Up a Console Interface Through Telnet	C-55
8.2	Console Commands.....	C-56
8.3	Console “CAL” “SET” Command Fields and Values.....	C-58
8.4	Query Commands: “S” or “C”	C-63
8.4.1	Converting Counts Per Force/Torque to FT Values.....	C-64
8.4.2	Secondary Commands for the Query “C” or “S” Command	C-64
8.4.3	Examples of Secondary Commands (Specifiers).....	C-65
8.4.4	How to Interpret the Output from “!” Specifier	C-67
8.5	Example of Tool Transformation Functionality Through Telnet	C-68
9.	Common Gateway Interface (CGI)	C-70
9.1	URL Syntax Construction:.....	C-70
9.1.1	Assigning New Values to a Variable	C-70
9.2	CGI Variable: Settings (setting.cgi)	C-71
9.3	Thresholding CGI (moncon.cgi).....	C-71
9.4	CGI Variable: Configurations (config.cgi).....	C-72
9.4.1	Example of Tool Transformation Functionality Through CGI.....	C-73
9.5	CGI Variable: Communications (comm.cgi).....	C-74
10.	TCP Interface	C-75
10.1	Command Codes.....	C-75

10.2	Read F/T Command.....	C-75
10.3	Read F/T Response	C-75
10.4	Read Calibration Info Command.....	C-76
10.5	Read Calibration Info Response	C-76
10.6	Write Tool Transform Command	C-77
10.7	Write Monitor Condition Command	C-77
10.8	Write Response	C-77
11.	XML Interface	C-78
11.1	System and Configuration Information (netftapi2.xml)	C-78
11.2	Calibration Information (netftcalapi.xml)	C-80
12.	UDP Interface Using RDT.....	C-81
12.1	RDT Protocol	C-81
12.1.1	RDT Request For Records Structure	C-82
12.1.2	RDT Records Sent Structure.....	C-82
12.2	Calculating F/T Values for RDT	C-83
12.3	Multiple Clients	C-83
12.4	Notes on UDP and RDT Mode	C-83
12.5	Example Code.....	C-83
13.	Troubleshoot.....	C-84
13.1	LED Errors	C-84
13.2	Ethernet Communication Questions and Errors.....	C-85
13.3	Ethernet Axia Webpage Errors.....	C-86
13.4	Java® Demo Errors	C-86
13.5	Basic Guidance for Troubleshooting	C-87
13.6	Reducing Noise	C-92
13.6.1	Mechanical Vibration	C-92
13.6.2	Electrical Interference.....	C-92
13.7	Improving Ethernet Throughput	C-92
13.7.1	Direct Connection between Axia Ethernet and Host	C-92
13.7.2	Choice of Operating System	C-92
13.7.3	Increasing Operating System Performance	C-92
13.7.4	Avoid Logging the Host to a Company Network.....	C-93
13.7.5	Use a Dedicated Network.....	C-93

14. Specifications	C-93
14.1 Electrical Specifications	C-93
14.2 Cable Specifications	C-93
14.2.1 P/N 9105-C-ZC22-ZC28-X	C-93
14.2.2 P/N 9105-C-ZC27-ZC28-X	C-93
14.2.3 P/N 9105-C-ZC28-ZC28-X	C-94
14.2.4 P/N 9105-C-ZC28-U-RJ45S-X	C-94
15. Terms and Conditions of Sale	C-95

Glossary

Term	Definitions
Active Configuration	The configuration that the system is currently using.
ADC	Analog-to-digital converter
Bias	Biasing is useful for eliminating the effects of gravity (tool weight) or other acting forces. When the bias function is used, the software collects data for the forces and torques that are currently acting on the sensor and use these readings as a reference for future readings. Future readings will have this reference subtracted from them before they are transmitted. Bias may also be referred to as “zero out” or “tare” the sensor.
Calibration	Defines a specific measurement or sensing range for a given sensor. Calibration is also the act of measuring a transducer’s raw response to loads and creating data used in converting the response to forces and torques.
CGI	Common Gateway Interface (CGI) is the method of using web URLs to communicate data and parameters back to a web device.
Complex Loading	Any force or torque load that is not purely in one axis.
Configuration	User-defined settings that include which force and torque units are reported and which calibration is to be used.
Control Panel	A feature on a personal computer operating system where a user can adjust system settings.
Coordinate Frame	See Sensor Reference Frame Origin.
Data Rate	How fast data can be output over the network.
DHCP	Dynamic Host Configuration Protocol (DHCP) is an automatic method for Ethernet equipment to obtain an IP address. The Ethernet Axia system can obtain its IP address using DHCP on networks that support this protocol.
DINT	Signed double integer (32 bit)
ENABL	Boolean that uses Enabled to represent 1 and Disabled to represent 0
Ethernet	A family of computer networking technologies commonly used in local area networks.
Fieldbus	A generic term referring to any one of a number of industrial computer networking standards. Examples include: Ethernet, CAN, Modbus, and PROFINET.
FT or F/T	Force and Torque.
F_{xy}	The resultant force vector comprised of components F_x and F_y .
Force	A force is a push or pull action on an object caused by an interaction with another object. Force = mass X acceleration
HEXn	Hexadecimal number of n bits, prefixed with 0x
HTTP GET Method	A standard and common method that a user can request data from a specified resource such as a sensor. HTTP works as a request-response protocol between client (web browser) and server (the sensor).
Hysteresis	A source of measurement error caused by the residual effects of previously applied loads.
INT	Signed integer (16 bit)
Interface Plate	A separate plate that attaches the sensor to another surface. Interface plates are often used if the bolt pattern on the sensor doesn’t match the bolt pattern on the robot arm or customer tooling. The interface plate has two bolt patterns, one on either side of the plate. One side is for the sensor. The other side is for the robot arm or customer tooling.
IP64	Ingress protection rating “64” designates protection against dust and splashing of water. An IP64 rating does not guarantee protection when a user submerges a device in water or any type of fluid.
IP67	Ingress protection rating “67” designates protection against dust and submersion under 1 m of fresh water.

Term	Definitions
IP Address	An IP Address (Internet Protocol Address) is an electronic address assigned to an Ethernet device so that it may send and receive Ethernet data. IP addresses may be either manually selected by a user or automatically assigned by the DHCP protocol.
Java™	Java is a programming language often used for programs on webpages. The Ethernet Axia demo is a Java application. Java is a registered trademark of Sun Microsystems, Inc.
MAC	Media Access Controller is the hardware that implements the lowest sub-layer of the data link layer.
MAC Address	MAC Addresses (Media Access Control Addresses) are the unique addresses given to every Ethernet device when it is manufactured, to be used as an electronic Ethernet serial number.
MAC ID	Media Access Code Identifier (MAC ID) is a unique number that is user assigned to each device on an Ethernet network. Also called Node Address.
Measurement Uncertainty	Commonly referred to as “accuracy”, “measurement uncertainty” is the worst-case error between the measured value and the true load. The measurement uncertainty is specified as a percentage of the full-scale measurement range for a given sensor model and calibration size. This value takes into account multiple sources of error. The sensor’s calibration certificate lists the measurement uncertainty percentage. For more information, refer to <i>Section 2.2: Measurement Uncertainty</i> in the Frequently Asked Questions (FAQ) document located at: https://www.ati-ia.com/library/documents/FT_FAQ.pdf .
Mechanical Coupling	When an external object such as customer tooling or utilities contacts a sensor’s surface between the sensor’s mounting side and tool side.
N/A	Not Applicable
NVM	Non-Volatile Memory. Storage of information or device memory that can be retrieved even after the device goes through a power cycle.
Overload	The condition where more load is applied to the sensor than the rated measurement range that can be applied to the sensor. Overloads result in reduced accuracy and potentially reduced sensor life.
Plug-in Technology	A customized program that when downloaded and installed onto a host device adds a specific feature to an existing computer program.
P/N	Part Number
Power Cycle	When a user removes and then restores power to a device.
REAL	Floating-point number (32 bit)
RDT	The rate per second at which the sensor sends streaming RDT data to a host. Raw Data Transfer (RDT) is a fast and simple Ethernet protocol for control and data transfer via UDP.
RDT Buffer Size	A mode where the sensor sends more than one data package per sample. Multiple data packages are buffered and sent in one block. Buffering reduces the amount of overhead data sent from the sensor and reduces the overall network traffic.
Sensor Reference Frame Origin	The point on the sensor from which all forces and torques are measured.
Sensor System (or configuration)	The entire assembly consisting of a sensor body and a system interface to translate force and torque signals into a specific communication interface/protocol.
Resolution	The smallest change in load that can be measured.
Sample Rate	How fast the ADCs are sampling inside the unit.
Sensor	The component that converts a detected load into electrical signals.
SINT	Signed short integer (8 bit)
STRING n	String of n characters
Status Bit	A unit of computer data sent from the ATI F/T sensor.

Term	Definitions
TCP	Transmission Control Protocol (TCP) is a low-level method of transmitting data over Ethernet. TCP provides a slower, more reliable delivery of data than UDP.
Thresholding	A software function of the sensor that performs a simple arithmetic comparison of a user-defined threshold to the loading on a transducer axis.
Torque	The application of a force through a lever or moment arm that causes something to want to turn. For example, a user applies torque to a screw to make it turn. Torque = force x moment arm length
T_{xy}	The resultant torque vector comprised of components T_x and T_y .
UART	Universal asynchronous receiver transmitter.
UDINT	Unsigned double integer (32 bit)
UDP	UDP (User Datagram Protocol) is a low-level method of transmitting data over Ethernet. While UDP is faster than TCP, unlike TCP lost UDP data is not resent.
UINT	Unsigned integer (16 bit)
USINT	Unsigned short integer (8 bit)

1. Safety

The safety section describes general safety guidelines to be followed with this product, explanations of the notifications found in this manual, and safety precautions that apply to the product. Product specific notifications are imbedded within the sections of this manual (where they apply).

1.1 Explanation of Notifications

These notifications are used in all of ATI manuals and are not specific to this product. The user should heed all notifications from the robot manufacturer and/or the manufacturers of other components used in the installation.



DANGER: Notification of information or instructions that if not followed will result in death or serious injury. The notification provides information about the nature of the hazardous situation, the consequences of not avoiding the hazard, and the method for avoiding the situation.



WARNING: Notification of information or instructions that if not followed could result in death or serious injury. The notification provides information about the nature of the hazardous situation, the consequences of not avoiding the hazard, and the method for avoiding the situation.



CAUTION: Notification of information or instructions that if not followed could result in moderate injury or will cause damage to equipment. The notification provides information about the nature of the hazardous situation, the consequences of not avoiding the hazard, and the method for avoiding the situation.

NOTICE: Notification of specific information or instructions about maintaining, operating, installing, or setting up the product that if not followed could result in damage to equipment. The notification can emphasize, but is not limited to: specific grease types, best operating practices, and maintenance tips.

1.2 General Safety Guidelines

The customer should verify that the sensor is rated for the maximum load and torque expected during operation. Because static forces are less than the dynamic forces from the acceleration or deceleration of the robot, be aware of the dynamic loads caused by the robot.

1.3 Safety Precautions



CAUTION: Modifying or disassembly of the sensor could cause damage and void the warranty. Use the supplied mounting interface plate and the provided tool side mounting bolt pattern to mount the sensor to the robot and customer tooling to the sensor. For more information, refer to the ATI customer drawings.



CAUTION: Probing openings in the sensor causes damage to the instrumentation. Avoid prying into the openings of the sensor.



CAUTION: Do not overload the sensor. Exceeding the single-axis overload values of the sensor causes irreparable damage.



CAUTION: The sensor should be protected from impact and shock loads that exceed rated ranges during transportation as the impacts can damage the sensor's performance. For more information about rated ranges, refer to the appropriate sensor manual in [Table 2.1](#).

2. Product Overview

The Ethernet Axia Force/Torque (F/T) sensor measures six components of force and torque ($F_x \setminus F_y \setminus F_z \setminus T_x \setminus T_y \setminus T_z$) and communicates this data to a device (such as a personal computer, robot, or PLC) that is compatible with an Ethernet communication interface. The ATI Axia-series product line differs from the other (non-Axia) ATI F/T sensor models. Thus, the Axia sensors have different options and available features. The Axia-series force/torque sensors are available in several different payload and communication interface versions. This manual covers the following topics for the Ethernet Axia interface version:

- Electrical specifications and wire information for cables
- Initial set-up of a serial console for Ethernet communications
- Operation (LEDs, filter rates, sampling rates, and Status codes)
- Compatibility with the ATI Net F/T sensor UDP interface and Java demo application (for more information, refer to [Section 12—UDP Interface Using RDT](#), [Section 7—Java® Demo Application](#), and the [9620-05-NET F/T](#) manual)
- Compatibility with parts of the ATI Net F/T web interface (for more information, [Section 6—ATI Ethernet Axia Webpages Interface](#) and the [9620-05-NET F/T](#) manual)
- ATI Ethernet Axia F/T sensor configuration through software interfaces: console interface through Telnet, Common Gateway Interface (CGI), TCP interface, UDP (RDT) interface, and XML
- Troubleshooting guidance that relates to Ethernet Axia

For additional sensor information, such as installation on a robot, operation, and general troubleshooting, refer to the appropriate ATI Axia F/T sensor manual listed in the following table:

Table 2.1—ATI Axia F/T Sensor Manual	
ATI Axia Sensor Model	Refer to the ATI Axia F/T Sensor Manual Document Number (#):
Axia80	ATI F/T Axia80 Sensor Manual (ATI Document # 9620-05-B-Axia80)
Axia90	ATI F/T Axia90 Sensor Manual (ATI Document # 9620-05-B-Axia90)
Axia130	ATI F/T Axia130 Sensor Manual (ATI Document # 9620-05-B-Axia130)

3. Installation



WARNING: Performing maintenance or repair on the sensor when circuits (for example: power, water, and air) are energized could result in death or serious injury. Discharge and verify all energized circuits are de-energized in accordance with the customer's safety practices and policies.



CAUTION: Avoid damage to the sensor from electrostatic discharge. Ensure proper grounding procedures are followed when handling the sensor or cables connected to the sensor. Failure to follow proper grounding procedures could damage the sensor.



CAUTION: Do not apply excessive force to the sensor and cable connector during installation, or damage will occur to the connectors. Align the keyway on the sensor and cable connector during installation to avoid applying excessive force to the connectors.



Keyway on the
sensor connector.

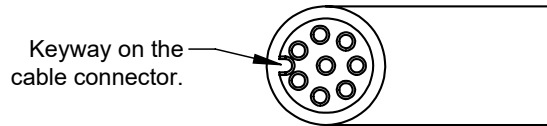

Keyway on the
cable connector.

3.1 Installation of the Sensor to the Robot

For instructions on how to install the sensor to the robot, refer to the appropriate sensor manual in [Table 2.1](#).

3.2 Cable Configuration

Cables can be configured a number of ways; however, the most common configurations are presented in the following:

Figure 3.1—Axia80/Axia90 Cable Configuration

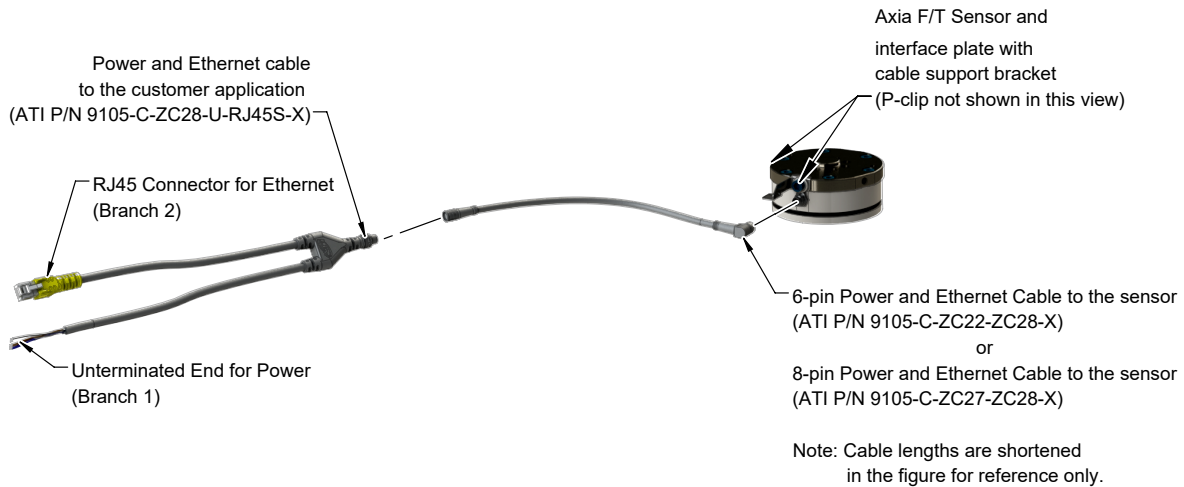
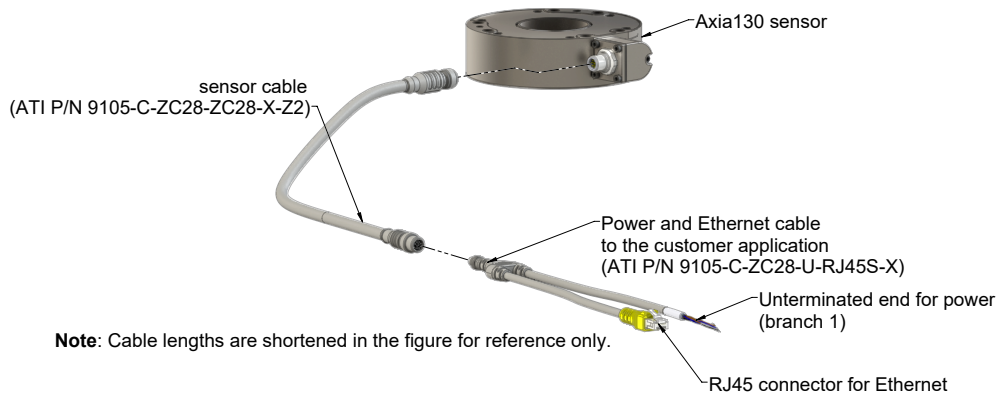



Figure 3.2—Axia130 Cable Configuration



3.3 Pin and Wire Assignments for Connectors

 **CAUTION:** Ensure the cable shield is properly grounded. Improper shielding on the cables can cause communication errors and an inoperative Axia sensor.

The following section provides the pin assignment for the connector on the Axia sensor and applicable connectors on the cables. For supply voltage ratings, refer to the following table or [Section 14.1—Electrical Specifications](#). For additional cable technical specifications, refer to [Section 14.2—Cable Specifications](#).

Power Source	Voltage			Power Consumption
	Minimum	Nominal	Maximum	Maximum
DC Power	12 V	24 V	30 V	1.5 W

Notes:

- The power supply input is reverse polarity protected. If the power and ground to the power supply inputs are plugged in reverse, then the reverse polarity protection stops the incorrectly wired supply input from damaging or powering on the sensor.

3.3.1 Pin Assignment for the Axia F/T Sensor

Signals and corresponding pin numbers for the Axia models are listed in the following sections.

3.3.1.1 Axia80 6-Pin M8 Male Connector

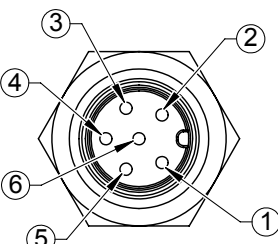
Table 3.2—Axia80 Sensor Connector, M8, 6-pin, Male		
Connector Schematic	Pin Number	Signal
	1	Tx +
	2	Tx -
	3	Rx +
	4	Rx -
	5	V +
	6	V - / 0 V / Ground
	Shell	Shield

3.3.1.2 Axia90 8-pin M8 Male Connector

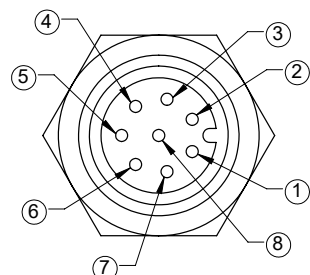
Table 3.3—Axia90 Sensor Connector, M8, 8-pin, Male		
Connector Schematic	Pin Number	Signal
	1	Reserved
	2	V +
	3	V - / 0 V / Ground
	4	Tx -
	5	Rx +
	6	Tx +
	7	Reserved
	8	Rx -
	Shell	Shield

3.3.1.3 Axia130 8-pin M12 Male Connector

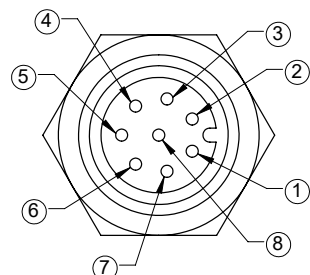
Table 3.4—Axia130 Sensor Connector, M12, 8-pin, Male		
Connector Schematic	Pin Number	Signal
	1	Reserved
	2	V +
	3	V - / 0 V / Ground
	4	Tx -
	5	Rx +
	6	Tx+
	7	Reserved
	8	Rx -
	Shell	Shield

3.3.2 Axia80 Sensor Cable (P/N 9105-C-ZC22-ZC28-X)

Table 3.5—ZC22 Connector, M8, 6-pin, Female		
Connector Schematic	Pin Number	Signal
	1	Tx +
	2	Tx -
	3	Rx +
	4	Rx -
	5	V +
	6	V - / 0 V / Ground
	Shell	Shield

Table 3.6—ZC28 Connector, M12, 8-pin, Male		
Connector Schematic	Pin Number	Signal
	1	Reserved
	2	V +
	3	V - / 0 V / Ground
	4	Tx -
	5	Rx +
	6	Tx +
	7	Reserved
	8	Rx -
	Shell	Shield

3.3.3 Axia90 Sensor Cable (P/N 9105-C-ZC27-ZC28-X)

Table 3.7—ZC27 Connector, M8, 8-pin, Female		
Connector Schematic	Pin Number	Signal
	1	Reserved
	2	V +
	3	V - / 0 V / Ground
	4	Tx -
	5	Rx +
	6	Tx +
	7	Reserved
	8	Rx -
Shell	Shield	

Table 3.8—ZC28 Connector, M12, 8-pin, Male

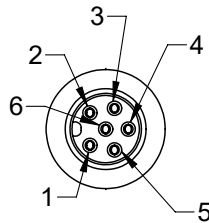
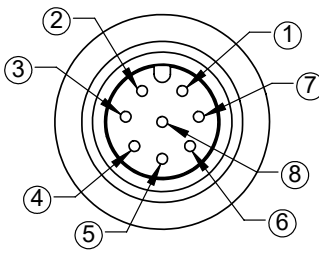
Connector Schematic	Pin Number	Signal
	1	Reserved
	2	V +
	3	V - / 0 V / Ground
	4	Tx -
	5	Rx +
	6	Tx +
	7	Reserved
	8	Rx -
	Shell	Shield

3.3.4 Axia130 Sensor Cable (P/N 9105-C-ZC28-ZC28-X)

Table 3.9—ZC28 Connector, M12, 8-pin, Female

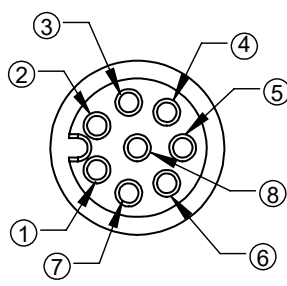
Connector Schematic	Pin Number	Signal
	1	Reserved
	2	V +
	3	V - / 0 V / Ground
	4	Tx -
	5	Rx +
	6	Tx +
	7	Reserved
	8	Rx -
	Shell	Shield

Table 3.10—ZC28 Connector, M12, 8-pin, Male

Connector Schematic	Pin Number	Signal
	1	Reserved
	2	V +
	3	V - / 0 V / Ground
	4	Tx -
	5	Rx +
	6	Tx +
	7	Reserved
	8	Rx -
	Shell	Shield

3.3.5 Ethernet Cable (P/N 9105-C-ZC28-U-RJ45S-X)

This cable has (2) branches: an unterminated end for power and an RJ45 connection for Ethernet. Both of these connections connect to the customer's device. For the signals and corresponding pin numbers/wire color, refer to the following sections.

Table 3.11—Branch 1, Unterminated End For Power	
Wire Jacket Color	Signal
Braided Metal Shield	Shield (Connect to Ground)
Brown	V+
Brown/White	V - / 0 V / Ground
Blue/White (TP1 +) ¹	Reserved
Blue (TP1 -) ¹	Reserved

Note:
 1. Reserved-not used.

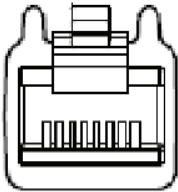
Table 3.12—Ethernet Connector, RJ45, 8-pin, Female			
Connector Schematic	Pin Number	Wire Color	Signal
 12345678	1	White/Orange	Tx +
	2	Orange	Tx -
	3	White/Green	Rx +
	4	-	No Connection
	5	-	
	6	Green	Rx -
	7	-	No Connection
	8	-	

4. Connecting Through Ethernet

Different methods for setting an IP address and how to configure a Windows® 7/8/10 operating system to connect the sensor to the ATI Ethernet Axia sensor webpages, are covered in the following sections.

For a sensor to connect through Ethernet, a user must configure the IP address setting of the sensor. The sensor can connect through Ethernet by one of the following options:

- Plug the end of the Ethernet cable into a port of an Ethernet switch that is connected to a computer.

NOTICE:

- If the computer does not have a spare Ethernet port, an additional port must be installed. Users should contact their IT department for assistance.

4.1 IP Address Configuration for Ethernet

To apply new IP address settings, power cycle the sensor. New IP address settings are only loaded upon power up. Configure an IP address for the Ethernet Axia sensor with one of the following methods:

- Method 1:** Set the IP address to a static value stored on the **Communication Settings** webpage. (refer to [Section 4.2—Connecting To the ATI Webpages Using a Windows Computer](#) steps 11 through 12)
- Method 2:** The DHCP server assigns an IP address. Enable this option in the Ethernet Axia's webpages (refer to [Section 4.2—Connecting To the ATI Webpages Using a Windows Computer](#) steps 11 through 12). To use this method, a DHCP server must be present in the network.

ATI ships the sensor with DHCP enabled and the static IP address set to 192.168.1.1. If the network does not support DHCP, the network automatically uses the static IP address. If a LAN connection is absent during power up, the network does not use DHCP. Users should contact their IT department for more information.

4.2 Connecting To the ATI Webpages Using a Windows Computer

To initially access the ATI Ethernet Axia F/T webpages, configure the sensor to work on the network by assigning an IP address and provide basic information about the network.

For the initial connection, directly connect the computer to the sensor and disconnect from LAN. The sensor's default IP address is 192.168.1.1. Temporarily change the computer's Ethernet adapter to a static IP address with the same first three fields as the sensor, for example: 192.168.1.100.

NOTICE: If the computer has multiple connections to Ethernet, such as a LAN connection and a wireless connection, select the LAN that will be connected to the Ethernet Axia sensor.

NOTICE: If the sensor's static IP address has been changed and is no longer set to the default, the computer's Ethernet adapter must be set to a static IP address with the same first three fields as the NEW sensor IP address. As an example, 192.168.1.100 works if the sensor is using the default IP address of 192.168.1.1.

1. Disconnect the Ethernet cable from the LAN port on the computer.
2. Open the computer's Internet Protocol (TCP/IP) Properties window:
 - For Windows® 10 operating system, complete the following steps:
 - a. From the Start menu, select the Control Panel.
 - b. Click on the **Network and Internet** icon.
 - c. Click on the **Network and Sharing Center** icon.
 - d. Click on the **Change adapter settings** link on the left side of the window.
 - e. A new window opens that displays the available network adapters. Right click the adapter the sensor is connected to and click on the **Properties** button. (refer to [Figure 4.1](#)).

Figure 4.1—Windows 10 Networking Connection

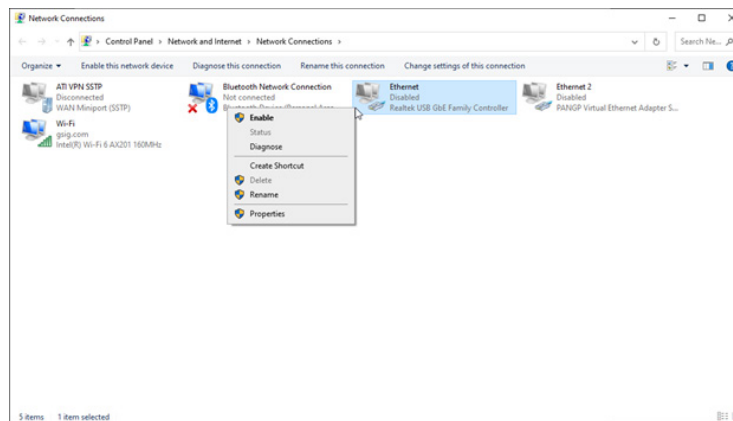

- f. On the **Networking** tab, scroll down and select **Internet Protocol Version 4 (TCP/IPv4)** connection item (refer to [Figure 4.2](#)).
- g. Click on the **Properties** button (refer to [Figure 4.2](#)).

Figure 4.2—Windows 10 Networking Information

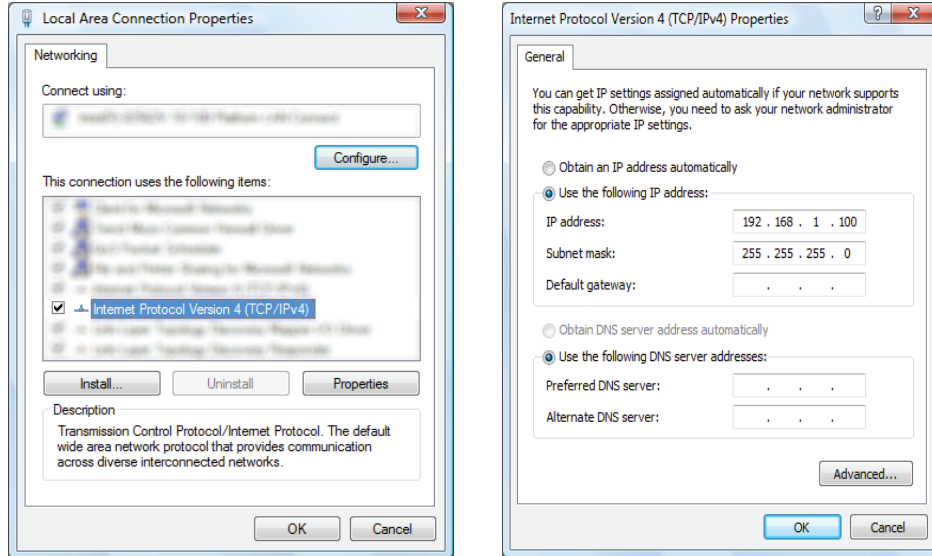

3. Record the values and settings shown in the properties window. Save these values so that the computer can be returned to its original configuration.
4. Select the **Use the following IP address** radio button.

NOTICE: IP addresses must be unique to each device. If 192.168.1.100 is already used by any other devices on the network, use another IP address with the same first three fields as the sensor.

5. In the **IP address:** field, type 192.168.1.100.
6. In the **Subnet mask** field, type 255.255.255.0.
7. Click on the **OK** button.
8. On the **Local Area Connection Properties** window, click the **Close** button.
9. Use an Ethernet cable to connect the sensor to the computer’s LAN connection. Wait a moment to ensure the computer has time to recognize the connection.
10. Type the address 192.168.1.1 in the browser. The Ethernet Axia F/T’s **Welcome** page appears.

Figure 4.3—The Ethernet Axia F/T Sensor Welcome Page

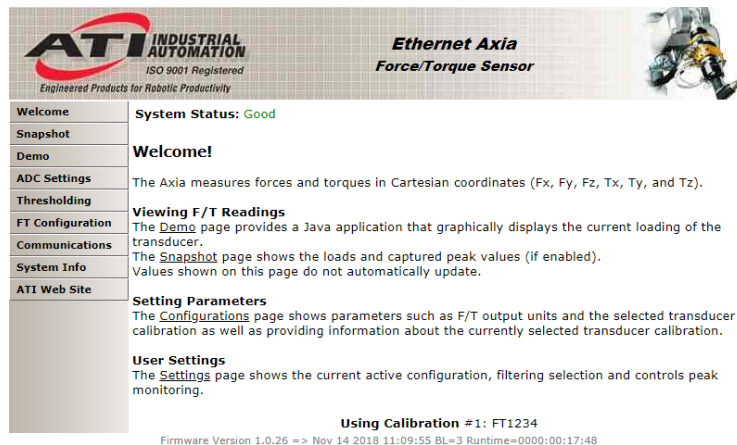

11. On the left side of the page is a menu bar with buttons that link to various Ethernet Axia webpages. Click on the **Communications** button.

Figure 4.4—The Ethernet Axia F/T Sensor Communications Page

Welcome	System Status: Good	
Snapshot		
Demo	Communications	
ADC Settings	These settings control how the sensor communicates with external equipment. Values are not stored unless the <i>Apply</i> button is clicked.	
Thresholding		
FT Configuration	Ethernet Network Settings	
Communications	A LAN connection must be present at power up for DHCP to function. If DHCP is enabled and no DHCP server is found then the static IP address will be used. These settings require the sensor to be powered off and then back on before they take effect.	
System Info		
ATI Web Site		
	Active	Selection
IP Address Mode:	Static IP	<input type="radio"/> DHCP <input checked="" type="radio"/> Static IP
IP Address:	192.168.137.15	<input type="text" value="192.168.137.15"/>
IP Subnet Mask:	255.255.255.0	<input type="text" value="255.255.255.0"/>
IP Default Gateway:	0.0.0.0	<input type="text" value="0.0.0.0"/>
Ethernet MAC Address:	00:16:bd:00:24:26	
	Raw Data Transfer (RDT) Settings	
	RDT data is routed through the local network and is not routed through the default gateway.	
RDT Output Rate (1 to 976):	<input type="text" value="900"/> Hz	NOTE: Does NOT change ADC Sampling Frequency on ADC Settings page.
RDT Buffer Size (1 to 40):	<input type="text" value="1"/>	
RDT UDP Port (0 to 65535):	<input type="text" value="49152"/>	NOTE: Do not use port number of any other active UDP service.
	TCP Interface Settings	
TCP Command Port (0 to 65535):	<input type="text" value="49151"/>	NOTE: Do not use port number of any other active TCP service.
Telnet Port (0 to 65535):	<input type="text" value="23"/>	NOTE: Do not use port number of any other active TCP service.
	<input type="button" value="Apply"/>	<input type="button" value="Cancel"/>

12. Select an IP address mode:

- For a static IP address, enter the appropriate values for the IP address, subnet mask, and default gateway. Click the **Apply** button. Power cycle the sensor.
- For DHCP, click the **Enabled** radio button next to DHCP, and then click the **Apply** button at the bottom of the page. Power cycle the sensor. If the sensor does not receive an IP address within 30 seconds after power up, the sensor defaults to use the static IP settings.
 - Find the IP address assigned to the sensor. (refer to [Section 4.3—Finding the Ethernet Axia Sensor on a Network](#))

NOTICE:

- When assigned by a DHCP server, IP addresses are not permanent and may change if the Ethernet Axia Sensor is disconnected from the network for a period of time. Users should contact their IT department in this situation. Static IP addresses are more favorable in permanent Ethernet F/T applications, because the IP address does not change.
- For a complete description of the fields on the **Communications** page, refer to [Section 6.7—Communication Page \(comm.htm\)](#).

13. Open up the TCP/IP properties of the local area connection of the computer.

- a. If the sensor was set to DHCP and a user's network has a DHCP server: restore the settings to what they were before reconfigured (use the values that were recorded in step 3).
- b. If the sensor was set to a static IP address or the network does not have a DHCP server: change the settings to an IP address on the same local subnet as the sensor. The first three fields of the IP address must be the same, but the last field must be unique. For example, if the sensor was set to 10.1.16.20, the computer can be set to 10.1.16.48 or 10.1.16.123.

14. Open up a new web browser window. Type the sensor's IP address into the browser's address bar, and press Enter.
 - The Ethernet Axia Sensor's **Welcome** page should display again.
15. Communicate with the sensor over the network, without reconfiguring the communications settings.

4.3 Finding the Ethernet Axia Sensor on a Network

To find the IP address assigned by the DHCP server to an Ethernet Sensor, refer to the following procedure;

1. Download ATI NET F/T Demo, the ATI F/T Data Viewer, or the ATI Discovery Tool from the ATI website: https://www.ati-ia.com/Products/ft/software/axia_software.aspx.
2. The first time this ATI Discovery Tool is downloaded, the program may trigger a firewall alert. Select the check boxes to give permission for the network to communicate with the sensor, and click the **Allow access** button.

Figure 4.5— Windows 7/8/10 Firewall Alert

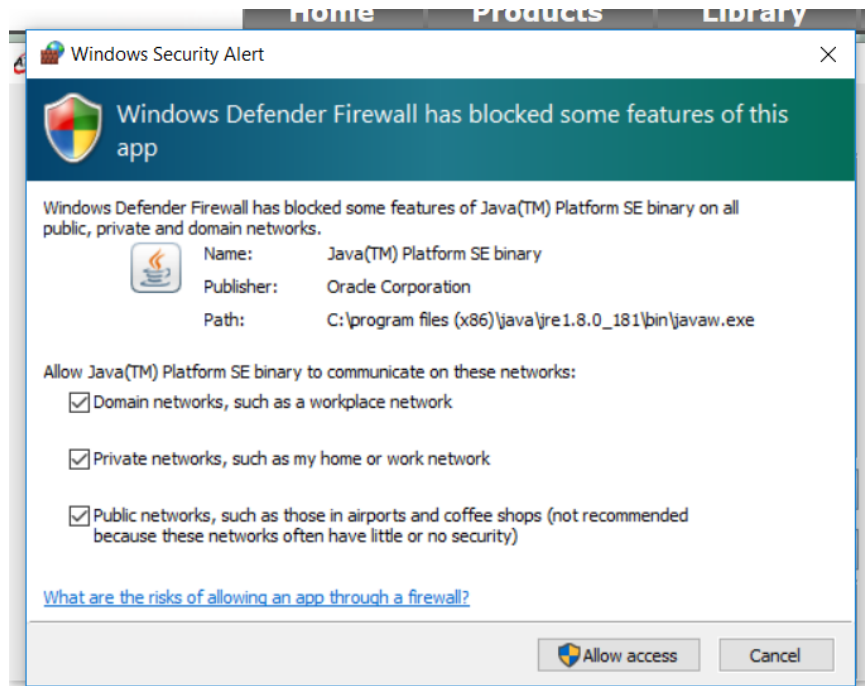

NOTICE: If the network is still not able to communicate, users should contact their IT Department for assistance.

3. The Discovery Tool opens in a window, and scans the network for available devices. The scan takes a few minutes. Verify the MAC address on the sensor's label matches the MAC address displayed in the window.
4. Use this IP address assigned by the DHCP server to the sensor's MAC address to communicate between the sensor and network.
5. Select this IP address and click **Connect**.

Figure 4.6—Discovery Tool

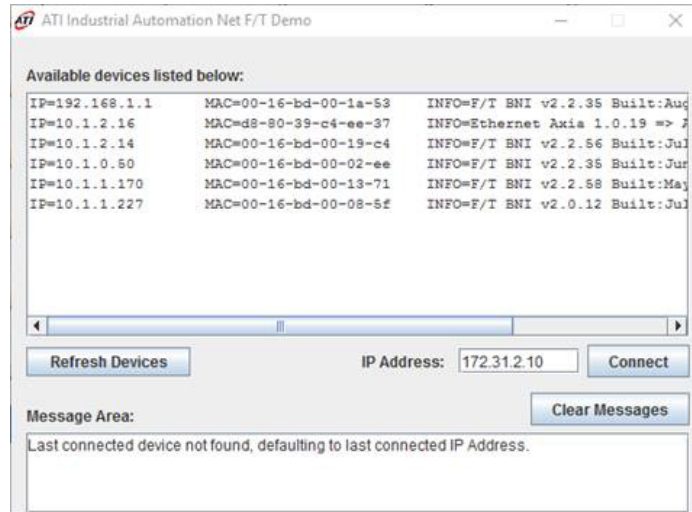

NOTICE: In addition to the ATI website, ATI provides this Discovery Tool in a directory that is sent to a user upon receipt of the sensor. To access the tool in the directory (9030-05-1026), open the folder "Utilities", open the folder "ATI Discovery Tool", and then install the file named "setup".

5. Operation

For general operation information about the sensor, refer to the appropriate sensor manual in [Table 2.1](#).

5.1 LED Self-Test Sequence

The Ethernet Axia sensor has three LEDs: Sensor Status, Link/Activity, and Diag. When a user applies power, the sensor completes a self-test, during which the LEDs under firmware control turn-on individually.

Table 5.1—LED Self-Test Sequence			
Sequence Order	LED	State	Duration
0	All	At power on, some transient activity may be seen for only a few milliseconds.	
1	All	Off	Approximately one second for each state.
2	Status	Red	
3	Diag	Red	
4	L/A	Red	
5	Status	Green	
6	Diag	Green	
7	L/A	Green	
8	All	Off	
9	All	Normal Operation	

Figure 5.1—LED Label on the Sensor

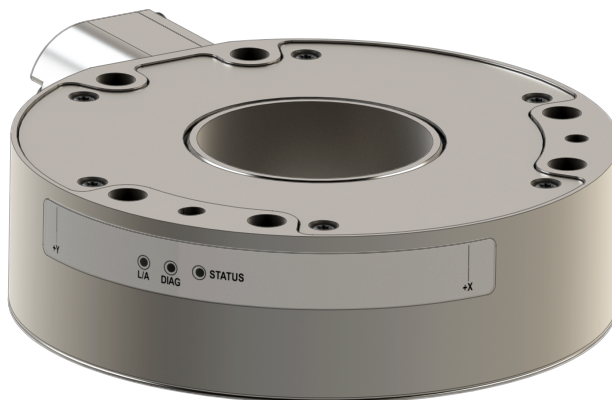

5.2 LED Normal Operation

5.2.1 Sensor Status LED

One LED signals the health status of the sensor as follows:

Table 5.2—Sensor Status LED		
LED Color	State	Description
Off	No power	Electricity is not supplied to the sensor.
Green	Normal operation	The sensor's electronics are functioning and communicating.
Amber ¹	Sensing range exceeded	Indicates that an F/T axis is out of range. Reduce the applied load or use a larger calibration if available.
Red (flash at 1 Hz speed)	Calibration error	Sensor is not referencing a calibration range or has a checksum error.
Red (flash at 10 Hz speed)	Communication error	The sensor is not able to communicate data over the communication protocol.
Red (solid)	Status code error	For more information on the error set, refer to Table 5.7 .
Note:		
1. Amber is when both green and red LEDs are on.		

5.2.2 Diag LED

One LED signals the diagnostic status of the Ethernet Axia sensor interface as follows:

Table 5.3—Diag LED		
LED Color	State	Description
Green Blinking	Pre-operational	Defined by the communication/protocol standard.
Green	Operational	No errors are found.
Red	Error	Indicates an error reported by the internal electronic components. Also, after a UART error, the LED stays red for five seconds.

5.2.3 Ethernet Link/Activity LED

One LED signals link/activity on the communications port as follows:

Table 5.4—L/A LED		
LED Color	State	Description
Off	No power or no link activity	Link/activity is not detected.
Green	Link activity	This light stays green for 5 seconds after any link activity.

5.3 Sample Rate

The power-on default sample rate is the rate a user sets before removing power. The sample rate is stored to nonvolatile memory. The ADC rate controls the current sample rate. The following table lists the rounded and exact sample rates.

Table 5.5—Sample Rate					
Rounded Sample Rate	0.5 kHz	1 kHz	2 kHz	4 kHz	8 kHz
Exact Sample Rate	488 Hz	976 Hz	1953 Hz	3906 Hz	7812 Hz

5.3.1 Sample Rate Versus Data Rate

The data rate is how fast data can be output over the Ethernet interface.

If the data rate is faster than the sample rate, the customer sees duplicate samples output over the network until the next sample is read internally. A faster data rate could be useful so that the sensor sends data at the same rate that other devices in a customer’s system are outputting. For example: if a device on the same application as the Axia is outputting data at 7,000 Hz, the customer may want the Axia to be outputting data to the network at 7,000 Hz as well, even though the sensor is not sampling that quickly internally.

If the sample rate is faster than the data rate, the customer does not receive the data from every internal sample over the network. However, any filters that are enabled work based on the faster internal sample rate, and so the sensor filters out higher frequency noise sources than if the filter is operating at a slower data rate.

5.4 Low-Pass Filter

The power-on default selection is “no filtering.” Users can issue a filter command via one of the Ethernet software interfaces to control the current filter selection. The cutoff frequency (for example: -3 dB frequency) is dependent on the sample rate selection, which is defined in [Section 5.3—Sample Rate](#). The cutoff frequencies for the different sampling rates are listed in the following table.

Table 5.6—Low-Pass Filtering					
Selected Filter	-3dB Cutoff Frequency (in Hz)				
	at 488 Hz Sample Rate	at 976 Hz Sample Rate	at 1953 Hz Sample Rate	at 3906 kHz Sample Rate	at 7912 Hz Sample Rate
0	200	350	500	1000	2000
1	58	115	235	460	935.10
2	22	45	90	180	364.04
3	10	21	43	84	169.52
4	5	10	20	40	81.24
5	2.5	5	10	20	39.84
6	1.3	3	5	10	20.31
7	0.6	1.2	2.4	4.7	9.37
8	0.3	0.7	1.4	2.7	5.47

Figure 5.2—Filter Attenuation at 0.5 kHz Sample Rate

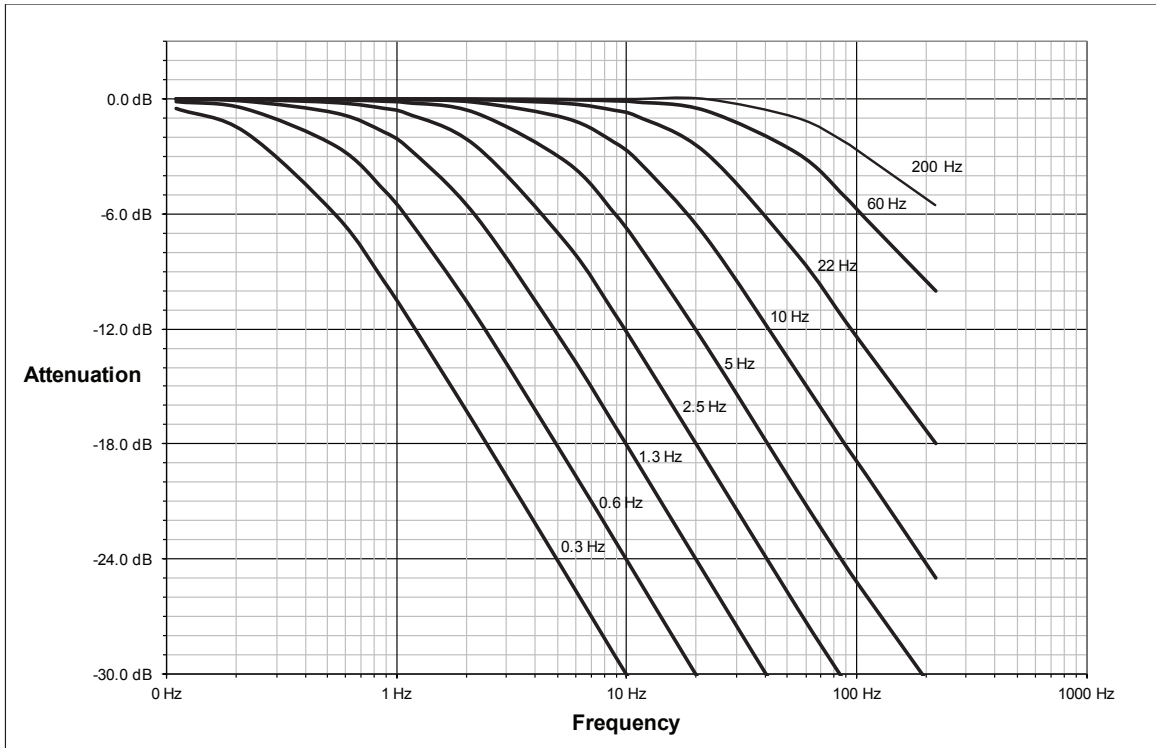

Figure 5.3—Filter Attenuation at 1 kHz Sample Rate

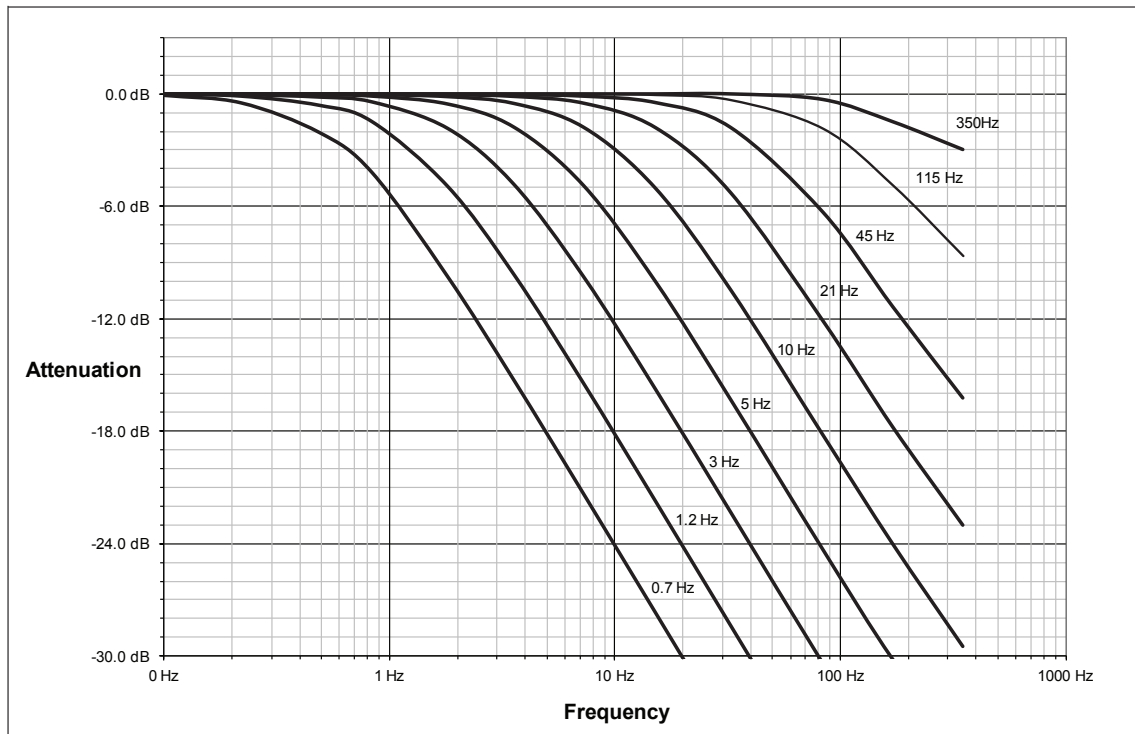

Figure 5.4—Filter Attenuation at 2 kHz Sample Rate

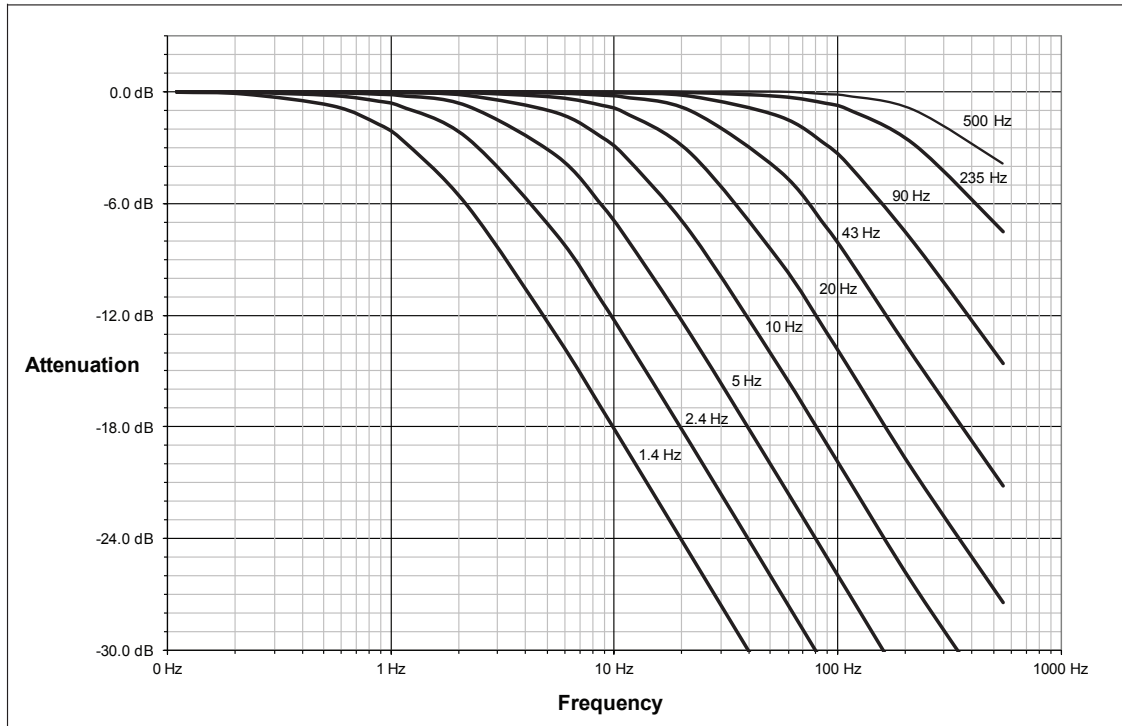

Figure 5.5—Filter Attenuation at 4 kHz Sample Rate

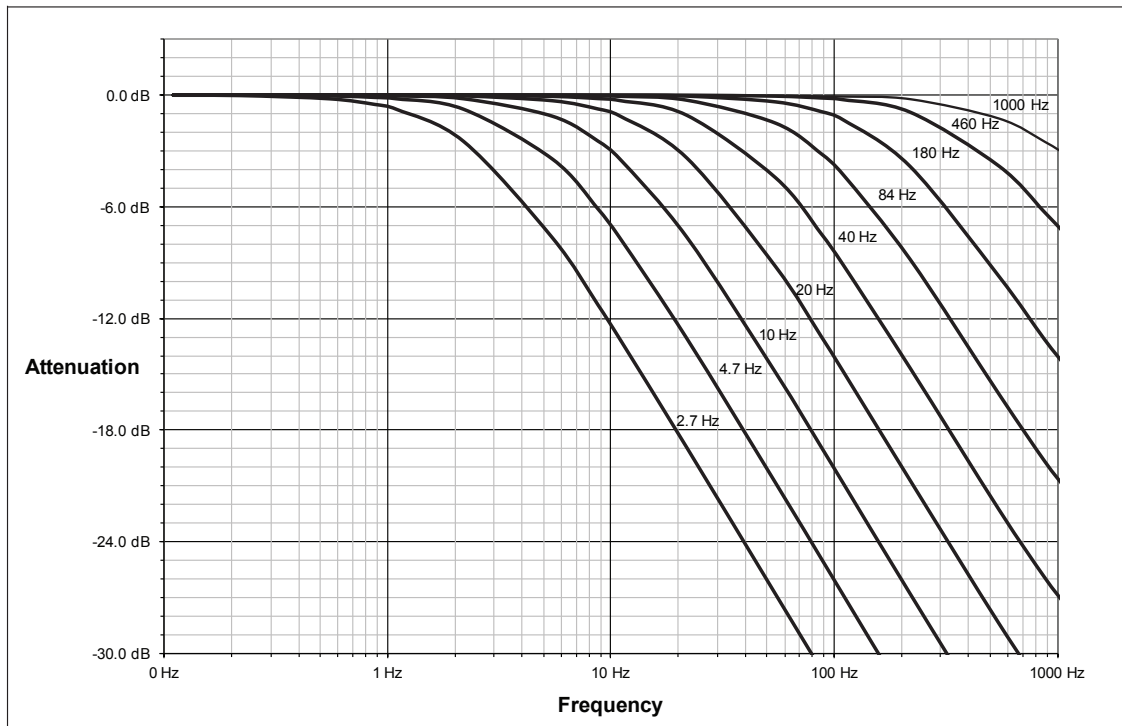
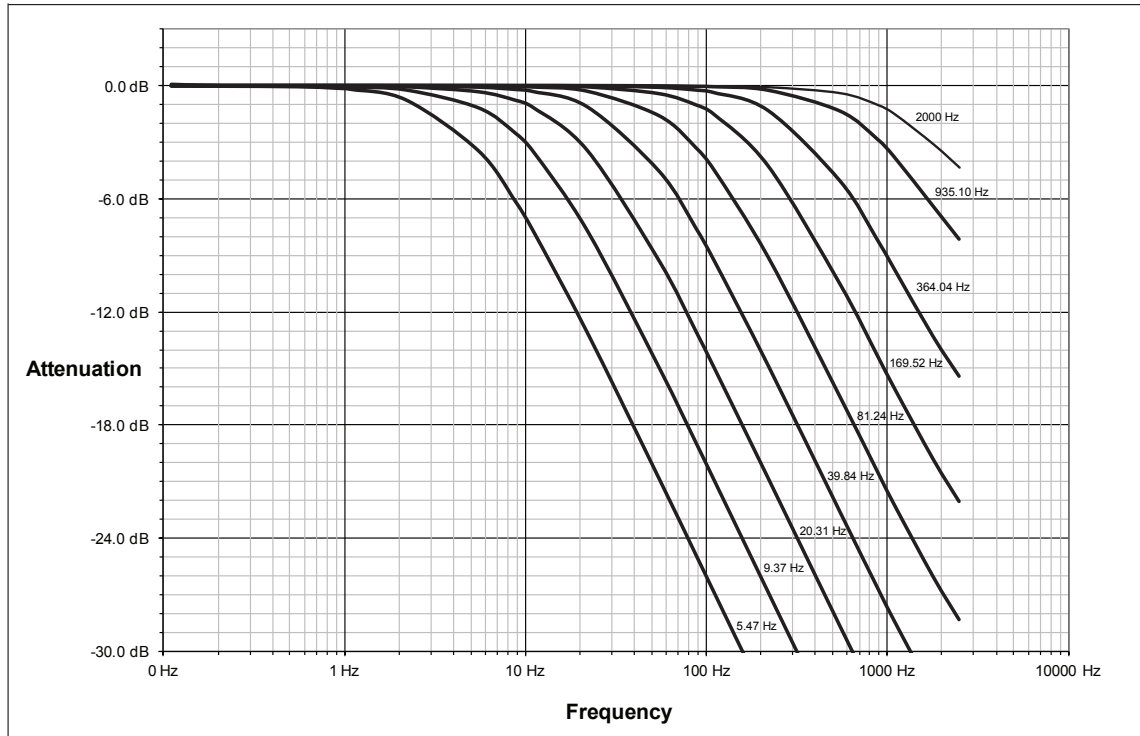

Figure 5.6—Filter Attenuation at 8 kHz Sample Rate



5.5 Status Code

A bitmap from bit number 0 to 31 for the current condition of the sensor is in the following table. The user can retrieve the status code using the Ethernet commands (refer to [Section 8.4.4—How to Interpret the Output from “!” Specifier](#)).

Table 5.7—Status Code		
Bit Number	Description	Indicates an Error?
0	Internal Temperature Out of Range: This bit is active (high) if the temperature is outside the range -5° to 70°C.	Yes
1	Supply Voltage Out of Range: This bit is active (high) if the input voltage is outside the range of 12 V to 32 V.	Yes
2	Broken Gage: This bit is active (high) whenever a gage reads positive full scale and indicates that the electrical connection to a gage is open or disconnected. It self resets 32 sample periods after the condition clears.	Yes
3	Busy Bit. The sensor is performing (1) or more of the following activities that may temporarily affect the F/T data: <ul style="list-style-type: none"> • Committing a change to NVM. • Changing the filter time constant. • Changing the calibration in use. • Changing the ADC sampling rate. • Any ADC ISR overrun. 	No
4	Reserved.	N/A
5	Other error bit. This bit is set whenever an error other than those specified in this table exists.	Yes
6	Reserved.	N/A
7	Calibration Not Accessible. This bit is set whenever this is an error with NVM and a user's calibration settings cannot be loaded. Perform an accuracy check as described in the applicable ATI sensor manual in Table 2.1 or in Section 4.5: How do I evaluate the accuracy of health of the sensor? in the Frequently Asked Questions (FAQ) ATI document located at: https://www.ati-ia.com/library/documents/FT_FAQ.pdf . If the sensor fails the accuracy check, return the sensor to ATI for inspection. Contact ATI at rma-admin@ati-ia.com for a Returned Materials Authorization (RMA).	Yes
8 to 26	Reserved.	N/A
27	Gage Out of Range: The bit is set whenever a gage sample is outside of the range gageMinRange to gageMaxRange. It self resets 32 sample periods after the condition clears.	Yes
28	Simulated Error. This bit is used to test user error handling.	No
29	Calibration checksum error: This bit is set if the active calibration has an invalid checksum.	Yes
30	Force/Torque Out of Range or Sensing Range Exceeded: This bit is active whenever the force/torque sample is out of range or saturated. It self resets 32 sample periods after the condition clears.	Yes
31	Error: This bit is set whenever any status code bit that indicates an error is set.	Yes

5.5.1 Status Code: Sensing Range Exceeded

Bit 30 in [Table 5.7](#) is set when an F/T load is outside the sensor’s detection capability. Bit 30 is set when either of the following conditions are TRUE:

- The total percentage of the calibrated range used by F_{xy} and T_z axes is greater than 105%. Refer to the following F_{xy} T_z equation:

$$\frac{\sqrt{F_x^2 + F_y^2}}{F_{XY} \text{CalibratedRange}} + \frac{|T_z|}{T_z \text{CalibratedRange}} > 105\%$$

- The total percentage of the calibrated range used by F_z and T_{xy} axes is greater than 105%. Refer to the following F_z T_{xy} equation:

$$\frac{|F_z|}{F_z \text{CalibratedRange}} + \frac{\sqrt{T_x^2 + T_y^2}}{T_{XY} \text{CalibratedRange}} > 105\%$$

- For Example:

An Axia90-M50 sensor that uses calibration range 0 is subjected to the following loads and has the following calibration ranges (Note: for calibration ranges, refer to the appropriate sensor manual in [Table 2.1](#)):

Axis	Applied Load	Calibration Range 0 Value
F_x	170.5 N	1000 N
F_y	-300.6 N	1000 N
F_z	-1400 N	2000 N
T_x	1.0 Nm	50 Nm
T_y	2.0 Nm	50 Nm
T_z	-45.5 Nm	50 Nm

The F_{xy} T_z equation simplifies as follows:

$$\frac{\sqrt{(170.5 \text{ N})^2 + (-300.6 \text{ N})^2}}{1000 \text{ N}} + \frac{|-45.5 \text{ Nm}|}{50 \text{ Nm}}$$

$$\frac{346 \text{ N}}{1000 \text{ N}} + \frac{45.5 \text{ Nm}}{50 \text{ Nm}}$$

$$35 \% + 91 \%$$

$$126 \% > 105 \%$$

TRUE

The $F_z T_{xy}$ equation simplifies as follows:

$$\frac{|-1400 \text{ N}|}{2000 \text{ N}} + \frac{\sqrt{(1.0 \text{ Nm})^2 + (2.0 \text{ Nm})^2}}{50 \text{ Nm}}$$

$$\frac{1400 \text{ N}}{2000 \text{ N}} + \frac{2.24 \text{ Nm}}{50 \text{ Nm}}$$

$$70 \% + 4.5 \%$$

$$74.5 \% \neq 105 \%$$

FALSE

Because the $F_{xy} T_z$ equation simplified to TRUE, bit 30 in [Table 5.7](#) is set.

6. ATI Ethernet Axia Webpages Interface

The ATI Ethernet Axia F/T sensor webpages provide full configuration options for the sensor. On the left side of the website, a menu bar has buttons that link a user to other pages for settings and sensor information.

The webpages use simple HTML browser scripting and do not require plug-in technology. If browser scripting is disabled, some non-critical user interface features are not available. The demo program is written in Java[®] and requires Java[®] to be installed on the computer.

The system status is displayed on all pages near the top of the page. This is the system status at the time a user loaded the page. To display the current system status a user must reload the page. Possible system status conditions are listed in [Section 5.5—Status Code](#).

Screenshots and a summary of the page's functionality or description of terms for each of the webpages is in the following sections.

Figure 6.1—Menu Bar

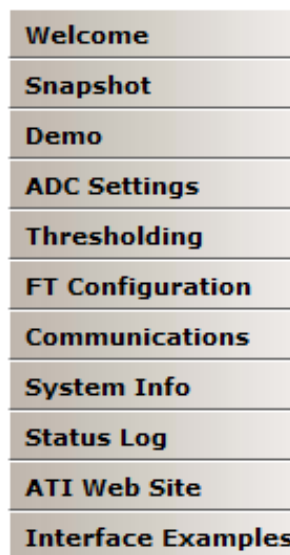

6.1 Welcome Page (index.htm)

When a user types the sensor's IP address into the browser address field, the Ethernet F/T **Welcome** page appears. The **Welcome** page gives an overview of the Ethernet Axia's main functions. The bottom of the page lists the calibration used by this configuration.

Figure 6.2—Welcome Page

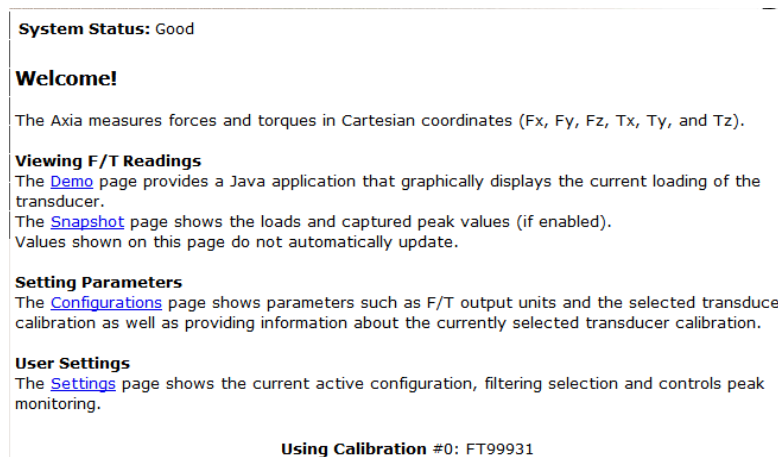

6.2 Snapshot Page (rundata.htm)

This page displays the current sensor loading conditions. The information on the **Snapshot** page is static and becomes current after a user loads or reloads the page.

Figure 6.3—Snapshot Page

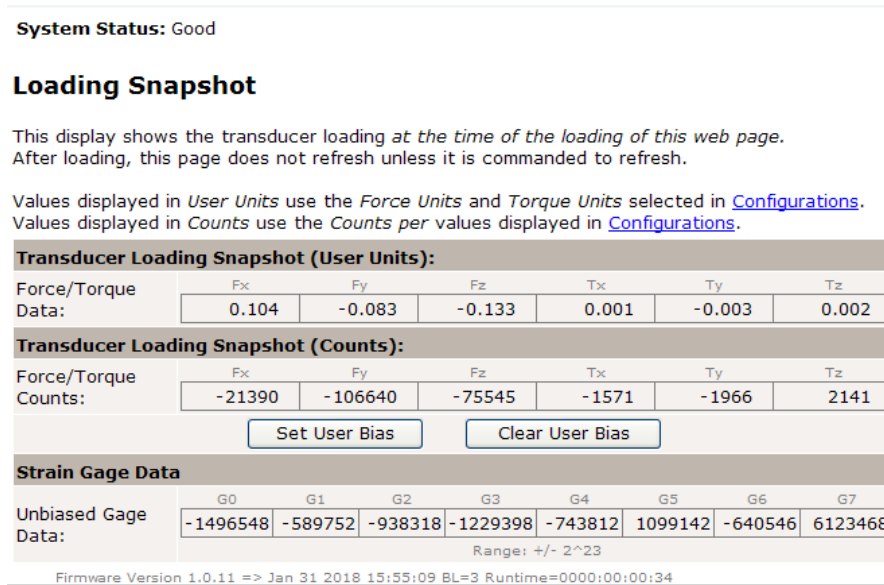

Transducer Loading Snapshot (User Units)

Force/Torque Data: These fields display the force and torque data scaled in units that a user selected on the **Configurations** page. If any strain gages are overloaded, these values are invalid and displayed in red with a line through them.

Transducer Loading Snapshot (Counts)

Force/Torque Counts: These fields display the force and torque data scaled with the counts per force and counts per torque displayed on the **Configurations** page. For more information about how F/T values are scaled, refer to [Section 8.4.1—Converting Counts Per Force/Torque to FT Values](#). If any strain gages are overloaded, these values are invalid and displayed in red with a line through them.

Strain Gage Data

Unbiased Gage Data: These fields display the sensor's raw strain gage information for troubleshooting overload errors. If the strain gages are overloaded, the values are invalid and displayed in red.

NOTICE:

- When an overload condition occurs, the reported force and torque values are invalid.
- Individual strain gage values do not correspond to individual force and torque axes.
- The sensor readings on this page are captured as the webpage requests them. It is possible that the readings towards the bottom of the page have come from later F/T data records than the readings towards the top of the page.

6.3 Demo Page (demo.htm)

From this webpage, a user may download the Java® Demo Application and additional demo software. See also [Section 7—Java® Demo Application](#).

Figure 6.4—Demo Page

System Status: Good

Demonstration Application

The demonstration application graphically displays transducer readings.

The application's features include:

- Display of transducer loading in real time as a bar graph and a 3D cube
- Ability to save transducer readings in CSV format
- Biasing of transducer readings to zero
- Reporting of communication errors

Click the *Download Demo Application* button to load and run the demo.
The IP address of this sensor is: 169.254.224.77

[Download Demo Application](#)
(66512 bytes)

Additional Demo Software

http://www.ati-ia.com/Products/ft/software/axia_software.aspx

The application requires Java version 6 (runtime 1.6.0) or later to run. Java can be downloaded from <http://www.java.com>. Java source code can be found in the sensor system documentation.

6.4 ADC Settings Page (setting.htm)

On the **ADC Settings** page, a user can select the following: the active calibration, ADC sampling frequency, low-pass filter cutoff frequency, and software bias values. When a user clicks the **Apply** button, the changes on this page are implemented on the sensor.

Figure 6.5— ADC Settings Page

System Status: Good

ADC Settings

These system settings are independent of configurations and affect all transducer readings.

Values are not stored unless the *Apply* button is clicked.

User Setup:

Active Calibration	#0 - FT001234												
ADC Sampling Frequency:	976 Hz												
Low-Pass Filter Cutoff Frequency:	None Hz												
Software Bias Values:	<table border="1"><tr><td>Fx</td><td>Fy</td><td>Fz</td><td>Tx</td><td>Ty</td><td>Tz</td></tr><tr><td>0</td><td>0</td><td>0</td><td>0</td><td>0</td><td>0</td></tr></table>	Fx	Fy	Fz	Tx	Ty	Tz	0	0	0	0	0	0
Fx	Fy	Fz	Tx	Ty	Tz								
0	0	0	0	0	0								

Force/Torque Counts

[Apply](#) [Cancel](#)

The descriptions for the fields on the **ADC Settings** page, [Figure 6.5](#), are the following:

Active Calibration: A user may select a calibration range to be applied to the force and torque readings. For more information about the calibration ranges, refer to the applicable sensor manual in [Table 2.1](#).

ADC Sampling Frequency: A user may select the sampling frequency for low-pass filtering. For more information about the sampling rate options, refer to [Section 5.3—Sample Rate](#).

Low-Pass Filter Cutoff Frequency: A user may select a value for the cutoff frequency for low-pass filtering. The **No Filter** value disables the low-pass filtering feature. For more information about the filtering values, refer to [Section 5.4—Low-Pass Filter](#).

Software Bias Values: A user may enter values for the bias offset applied to the sensor strain gage readings. To remove the bias offset, set the fields to all zeros.

Note that the strain gage readings do not have a 1:1 correspondence to force and torque readings.

6.5 Thresholding Page (moncon.htm)

On the **Thresholding** page, a user can set up to 16 threshold conditions. Threshold conditions compare the sensor readings to simple user-defined threshold statements. After a user enables threshold monitoring and a sample is read, a user-defined output code for all threshold conditions satisfied by that sample are compared with a bitwise OR function or AND function (as defined by a user) to form the threshold output. In practice, it is very unlikely that more than one threshold sample is satisfied in a single sample. If the threshold conditions are exceeded, the threshold monitoring latch is set, and threshold monitoring is paused until a user issues a reset command or a user defined momentary time delay has passed.

Each threshold condition can be configured for the:

- Axis to monitor
- Type of comparison to perform
- Threshold value to use for the comparison
- Output code to send when the comparison is true

Figure 6.6—Thresholding

System Status: Threshold Level Latched

Thresholding

When *Threshold Monitoring* is enabled the Axia compares transducer force and torque values to the *Threshold Conditions* that are turned on. The *Output Codes* for all true conditions are combined to form the *Thresholds Output*.

The *Units* column displays the force or torque counts value in user units, but it is not updated until the *Apply* button is clicked.

Values are not stored unless the *Apply* button is clicked.

Thresholding Settings

When *Relay Trigger* item *Any condition is true* is selected the *Thresholds Output* is the result of a bitwise-OR operation on valid *Output Codes*. When *All conditions are true* is selected a bitwise-AND operation is performed.

Threshold Monitoring: Enabled Disabled

Relay Trigger: Any condition is true All conditions are true

Relay Behavior: Momentary Latching

Relay Momentary Minimum-On Time: × 0.1 seconds only applies when *Relay Behavior* is set to *Momentary*

WARNING: In systems without the solid-state relay option, setting this value to 0 could cause premature relay failure due to excessive activation.

Threshold Conditions:	N	On	Off	Axis	Comparison	Counts	Units	Output Code
0	<input checked="" type="radio"/>	<input type="radio"/>		If Fx ▾	< ▾	1000000	1 N Then	0
1	<input checked="" type="radio"/>	<input type="radio"/>		If Fx ▾	< ▾	1000000	1 N Then	0
2	<input type="radio"/>	<input checked="" type="radio"/>		If Fx ▾	> ▾	0	0 N Then	0
3	<input type="radio"/>	<input checked="" type="radio"/>		If Fx ▾	> ▾	0	0 N Then	0
4	<input type="radio"/>	<input checked="" type="radio"/>		If Fx ▾	> ▾	0	0 N Then	0
5	<input type="radio"/>	<input checked="" type="radio"/>		If Fx ▾	> ▾	0	0 N Then	0
6	<input type="radio"/>	<input checked="" type="radio"/>		If Fx ▾	> ▾	0	0 N Then	0
7	<input type="radio"/>	<input checked="" type="radio"/>		If Fx ▾	> ▾	0	0 N Then	0
8	<input type="radio"/>	<input checked="" type="radio"/>		If Fx ▾	> ▾	0	0 N Then	0
9	<input type="radio"/>	<input checked="" type="radio"/>		If Fx ▾	> ▾	0	0 N Then	0
10	<input type="radio"/>	<input checked="" type="radio"/>		If Fx ▾	> ▾	0	0 N Then	0
11	<input type="radio"/>	<input checked="" type="radio"/>		If Fx ▾	> ▾	0	0 N Then	0
12	<input type="radio"/>	<input checked="" type="radio"/>		If Fx ▾	> ▾	0	0 N Then	0
13	<input type="radio"/>	<input checked="" type="radio"/>		If Fx ▾	> ▾	0	0 N Then	0
14	<input type="radio"/>	<input checked="" type="radio"/>		If Fx ▾	> ▾	0	0 N Then	0
15	<input type="radio"/>	<input checked="" type="radio"/>		If Fx ▾	> ▾	0	0 N Then	0

Counts range: -2147483648 to +2147483647; Output code range: 0x00 to 0xFF

Status of Thresholds: 0 1 -2 -3 -4 -5 -6 -7 -8 -9 -10 -11 -12 -13 -14 -15

Use the *Get Statuses* button to update this static display of threshold statuses. Threshold numbers are crossed out if the threshold is unsatisfied. The *On/Off* setting for the threshold is ignored in this display.

Threshold Monitoring: A user can enable or disable threshold monitoring by clicking the radial button.

Relay Trigger: The user can select if the output code is calculated by bitwise OR'ing (trigger if any condition is true) or bitwise AND'ing (trigger only if ALL conditions are true).

Reset Latch button: Clears any threshold latching.

Relay Momentary Minimum-On Time: The user may select in how many tenths of a second (0 to 25.5 seconds) that the the firmware should wait in momentary mode before automatically resetting the monitor latch condition.

In case of any enabled threshold condition becoming true, the following occurs:

- The threshold's output code is updated.
- Bit 16 of the status code (*Table 5.7*) is set

Bit 16 holds these states until a user clicks the **Reset Latch** button on the **Thresholding** screen.

Threshold Condition Elements:

N: Statement number.

On / Off: Selects which statements are to be included in the processing of threshold conditions.

Axis: Selects the axis to be used in the comparison statement. Available axes are:

Table 6.1—Thresholding Statement Axis Selections	
Menu Value	Description
blank	Statement disabled
Fx	Fx axis
Fy	Fy axis
Fz	Fz axis
Tx	Tx axis
Ty	Ty axis
Tz	Tz axis

Comparison: Selects the type of comparison to perform. Available comparisons are:

Table 6.2—Thresholding Statement Comparison Selections	
Menu Value	Description
>	Greater Than
<	Less Than

Counts: The loading level to be compared to the sensor reading. This value displays in the units of the active configuration, after a user clicks the **Apply** button.

To determine the Counts value to use from a value in user units, multiply the value in user units by Counts per Force (or Counts per Torque if appropriate).

Example:

Desired Loading Level 6.25 N

Force Units: N (from Configurations page)

Counts per Force value 1000000 (from Configurations page)

Counts = Desired Loading Level × Counts per Force

= 6.25 N × 1000000 counts/N

= 6250000 counts

NOTICE: Comparison levels are stored as counts and only change when a user inputs new counts values. Changing the configuration or the force units or the torque units does not change or adjust the counts values.

Units: Displays the counts value in the units of the active configuration. This value is only updated after the Apply button is clicked.

Output Code: When this statement's comparison is found true, this 8-bit value will be bitwise OR'ed with the Output Code values of all other true statements to form the threshold output. Any set bits remain latched until a user issues a **Reset Latch**. If no statements are true the threshold output is zero.

The value displays in hexadecimal, format 0x00. A user may type output codes in hexadecimal format or in decimal. Bit pattern representing each thresholding statement number are in the following table.

#:	Bit Pattern	#:	Bit Pattern	#:	Bit Pattern	#:	Bit Pattern
0:	0x00000001	4:	0x00000010	8:	0x00000100	12:	0x00001000
1:	0x00000002	5:	0x00000020	9:	0x00000200	13:	0x00002000
2:	0x00000004	6:	0x00000040	10:	0x00000400	14:	0x00004000
3:	0x00000008	7:	0x00000080	11:	0x00000800	15:	0x00008000

Get Statuses: Click the **Get Statuses** button to update the static display of the threshold status. If a threshold is unsatisfied, the threshold numbers are crossed out.

6.6 F/T Configurations Page (config.htm)

On the **Configurations** page, a user may select the active calibration and tool transformation settings for the sensor system. When a user clicks the **Apply** button, the changes on this page are implemented on the sensor. For more information about a sensor’s calibration ranges and the concept of the tool transformation feature, refer to the applicable manual in [Table 2.1](#).

From the **Configurations** page, a user may obtain the following values: the sensor’s **Serial Number**, **Part Number**, calibration **Family**, **Time** or date the sensor was calibrated, force units, torque units, counts per force, and counts per torque. Note that these are the same values that are in [Section 8.3—Console “CAL” | “SET” Command Fields and Values](#) and [Section 11.2—Calibration Information \(netfcalapi.xml\)](#).

For more information about how F/T values are scaled with the counts per force and counts per torque, refer to [Section 8.4.1—Converting Counts Per Force/Torque to FT Values](#).

The **Calibrated Sensing Range** field displays the maximum rating for each axis of the selected calibration.

Figure 6.7—Configurations Page

System Status: Good

FT Configuration

Values are not stored unless the *Apply* button is clicked.

Calibration #1 (Active calibration)

Calibration Select: #1 - FT001234

Serial Number: FT001234

Part Number: US-00000-11111

Family: ENET

Time: 1970-01-01 00:00

Force Units: lbf

Torque Units: lbf-in

Counts per Force: 1000000

Counts per Torque: 1000000

FT Out of Range Parameters (Units):

Fx	Fy	Fz	Tx	Ty	Tz
2147	2147	2147	2147	2147	2147

These values apply to the factory origin (without tool transformation).

16-bit Scale Factors:

SF0	SF1	SF2	SF3	SF4	SF5
5	6	7	8	9	10

Counts Per Force in 16-bit Mode:

Fx	Fy	Fz	Tx	Ty	Tz
200000.00	166666.67	142857.14	125000.00	111111.11	100000.00

Tool Transform

Distance Units: in

Angle Units: degrees

Tool Transform:

Dx	Dy	Dz	Rx	Ry	Rz
0	0	0	0	0	0

Using a tool transformation will change how transducer readings are reported and change the apparent sensing ranges and apparent resolutions. Values are floating-point. Order of Operations: 1. Translations (order does not matter) 2. X-Rotations 3. Y-Rotations 4. Z-Rotations

Apply Cancel

6.7 Communication Page (comm.htm)

On the **Communication** page, a user may view and edit the system’s Ethernet networking options. Usually these settings are set once when a user first setup the system and do not need to be changed later. A detailed overview of setting up Ethernet communications with the sensor is in [Section 4—Connecting Through Ethernet](#).

Figure 6.8—Communications Page

System Status: Good

Communications

These settings control how the sensor communicates with external equipment. Values are not stored unless the *Apply* button is clicked.

Ethernet Network Settings

A LAN connection must be present at power up for DHCP to function. If DHCP is enabled and no DHCP server is found then the static IP address will be used. These settings require the sensor to be powered off and then back on before they take effect.

	Active	Selection
IP Address Mode:	Static IP	<input type="radio"/> DHCP <input checked="" type="radio"/> Static IP
IP Address:	169.254.224.77	<input type="text" value="169.254.224.77"/>
IP Subnet Mask:	255.255.0.0	<input type="text" value="255.255.0.0"/>
IP Default Gateway:	0.0.0.0	<input type="text" value="0.0.0.0"/>
Ethernet MAC Address:	00:16:bd:c4:f9:25	

Password Protection Settings

Change Username:

Change Password:

Old Password:	<input type="password"/>	New Password:	<input type="password"/>
	<input type="password"/>	Retype New Password:	<input type="password"/>

Require Credentials: On Off

Raw Data Transfer (RDT) Settings

RDT data is routed through the local network and is not routed through the default gateway.

RDT Output Rate (1 to 976): Hz NOTE: Does NOT change ADC Sampling Frequency on ADC Settings page.

RDT Buffer Size (1 to 40):

RDT UDP Port (0 to 65535): NOTE: Do not use port number of any other active UDP service.

TCP Interface Settings

TCP Command Port (0 to 65535): NOTE: Do not use port number of any other active TCP service.

Telnet Port (0 to 65535): NOTE: Do not use port number of any other active TCP service.

Counts Per Force in 16-bit Mode:	Fx	Fy	Fz	Tx	Ty	Tz
	200000.00	166666.67	142857.14	125000.00	111111.11	100000.00

The descriptions for the fields on the **Communications** page, [Figure 6.8](#), are the following:

Ethernet Network Settings

IP Address Mode: A user can configure the IP address of the sensor (refer to [Section 4.1—IP Address Configuration for Ethernet](#)).

Static IP Address: A user can set the static IP address (refer to [Section 4.1—IP Address Configuration for Ethernet](#)).

Static IP Subnet Mask: This field is for the subnet mask portion of the IP address. Many networks use the default 255.255.255.0. Users should contact their IT department to know what static IP subnet mask to assign.

IP Default Gateway: This field is for the default gateway. Users should contact their IT department to know what default gateway to assign.

Ethernet MAC Address: A unique address that given to the sensor at the time of manufacture. This address uniquely identifies this sensor from other sensors and other Ethernet devices.

Password Protection Settings

Users can change the Username or Password. Only the Username is readable and the old password is hidden. The default Username is “admin”, and the default Password is “password”.

Require Credentials: If ON, this setting activates a login prompt when a user visits the sensor’s webpages. The default setting is OFF.

NOTICE: Detailed information about RDT settings with a UDP interface is in [Section 12—UDP Interface Using RDT](#).

Raw Data Transfer (RDT) / UDP Settings

RDT is ATI’s UDP protocol. These settings are applicable for UDP.

NOTICE: Changing the **RDT Output Rate** does not change the **ADC Sampling Frequency** on the ADC Settings page ([Section 6.4—ADC Settings Page \(setting.htm\)](#)).

RDT Output Rate: A user can set the RDT output rate from 1 to the value of the ADC sampling rate in [Section 5.3—Sample Rate](#).

RDT Buffer Size: A user can set the RDT buffer size to a value from 1 to 40.

RDT UDP Port: The default setting is 49152 (see [Section 12—UDP Interface Using RDT](#)). It is recommended to leave this value as the default unless another device is using that UDP port. A user can set a value from 0 to 65535.

NOTICE: When setting the port for the TCP interface, be careful to not input a port number that is being used by any other active TCP service.

TCP Interface Settings

TCP Command port: The default setting is 49151 (see [Section 10—TCP Interface](#)). It is recommended to leave this value as the default unless another device is using that TCP port. A user can set a value from 0 to 65535.

Telnet Port: The default setting is 23, which is the default port setting for all industry standard Telnet communication. It is recommended to leave this value as the default. A user can set a value from 0 to 65535.

6.8 System Information Page (manuf.htm)

The **System Information** page provides a user with a summary of the Ethernet Axia sensor’s current state. ATI application engineers refer to this page when troubleshooting the sensor. For status codes, refer to [Section 5.5—Status Code](#). On the top of the page, **System Status** is *good*, if all hardware diagnostics report “good”. The **System Status** is *bad*, if any hardware diagnostics report “bad”.

Figure 6.9—System Information Page

System Status: Good

System Information

This is a summary of the system's current state.
 This information may be helpful during troubleshooting.

Transducer

	G0	G1	G2	G3	G4	G5	G6	G7
Strain Gage Values:	-1487900	-575588	-926234	-1229830	-738364	1108470	-693896	6257524
Software Bias Values:	Fx	Fy	Fz	Tx	Ty	Tz		
	0	0	0	0	0	0		
Force/Torque Counts:	-11681364	31506724	11037848	211105	37313	92829		
Force/Torque Units:	N	N	N	Nm	Nm	Nm		
Run-time Matrix:	G0	G1	G2	G3	G4	G5		
	Fx	-78.8319	-72.1477	-7.21988	-7.11622	-72.1291	79.7986	
	Fy	-37.8669	50.5185	88.5176	-89.2425	-50.1949	38.2310	
	Fz	59.4185	59.8229	60.9954	59.5984	64.2795	55.949	
	Tx	-2.12904	-1.27252	0.955521	-0.958976	1.33332	2.05951	
	Ty	0.132833	1.80583	-2.01164	-1.9061	1.8916	0.0858098	
	Tz	2.02883	-2.05575	2.03322	-2.00783	2.07986	-2.07972	

Calibrations

Using Calibration #0

	Serial Number	Part Number	Family	Time	
Calibrations:	0	FT99931	SI-500-20	NET	2/5/2018
	1	FT99932	SI-200-8	NET	2/5/2018

Board

Status Word: 0x00000000
 Ethernet MAC Address: 00:16:bd:00:22:15
 Serial Number: Serial number
 Firmware Revision: 1.0.11 => Jan 31 2018 15:55:09 BL=3
 Hardware Revision: 0
 Hardware Product Code:

HW Product Code	Status	Details
NVM-Image-0	Good	525 K bytes
NVM-Image-1	----	
SPI-Param-0	Good	1164 bytes
SPI-Param-1	Good	1164 bytes
RAM-Param	Good	1164 bytes
UART	----	115.4 KHz RX faults: 0
SPI-ADC	----	14.0 MHz

Run-time Matrix:

	G0	G1	G2	G3	G4	G5
Fx	-78.8319	-72.1477	-7.21988	-7.11622	-72.1291	79.7986
Fy	-37.8669	50.5185	88.5176	-89.2425	-50.1949	38.2310
Fz	59.4185	59.8229	60.9954	59.5984	64.2795	55.949
Tx	-2.12904	-1.27252	0.955521	-0.958976	1.33332	2.05951
Ty	0.132833	1.80583	-2.01164	-1.9061	1.8916	0.0858098
Tz	2.02883	-2.05575	2.03322	-2.00783	2.07986	-2.07972

Calibrations

Using Calibration #0

	Serial Number	Part Number	Family	Time	
Calibrations:	0	FT99931	SI-500-20	NET	2/5/2018
	1	FT99932	SI-200-8	NET	2/5/2018

Board

Status Word: 0x00000000
 Ethernet MAC Address: 00:16:bd:00:22:15
 Serial Number: Serial number
 Firmware Revision: 1.0.11 => Jan 31 2018 15:55:09 BL=3
 Hardware Revision: 0
 Hardware Product Code:

HW Product Code	Status	Details
NVM-Image-0	Good	525 K bytes
NVM-Image-1	----	
SPI-Param-0	Good	1164 bytes
SPI-Param-1	Good	1164 bytes
RAM-Param	Good	1164 bytes
UART	----	115.4 KHz RX faults: 0
SPI-ADC	----	14.0 MHz
SPI-EEPROM	----	14.0 MHz
MCU-Clock	Good	168.0 MHz
MCU-Part	Good	PIC32MZ2048EFH064 A1 S/N: c591d880 39c4eH4
MCU-WatchDog	Good	Timeout = 62.500 ms Windowed = Off
MCU-RCM	Good	BrownOutReset PowerOnReset
MCU-Supply	Good	24.1 V
MCU-Regs	Good	
MCU-PC	Good	
MCU-RAM	----	512 K bytes Errors: 0
MCU-GPIO	Good	
PCB-Temp	Good	39.3 °C
Gage-Temp	Good	25.3 °C
ADC-Gages	Good	Spikes: 0
ADC-RegW	Good	
ADC-Intrpt	Good	ISR overruns: 0 CRC errors: 0
PHY-State	Good	ISR overruns: 0
EEPROM	Good	Retries: 0
MonTime	Good	Max: 481 uS
Stack	Good	394060 bytes available of 395768 bytes allocated

6.10 Interface Example Page (examples.htm)

On the **Interface Example** page, a user can view TCP and RDT (UDP) commands, command descriptions, the command response (if applicable), and a user-interpretation of the command. For more information on TCP and RDT(UDP), refer to [Section 10—TCP Interface](#) and [Section 12—UDP Interface Using RDT](#).

Figure 6.11—Interface Example Page

System Status: Good

Interface Examples

TCP Examples			
Description	Command (Hex)	Response (Hex)	Interpretation
Read FT	00 00 00 00 00 00 00 00 00 00 00 00 00 00 00 00 0000 0000	1234 0000 044E FE80 F185 FAD3 E8D6 0177	Status = 0x00 Fx = 1102 Counts (16.82 N*) Fy = -384 Counts (-5.860 N*) Fz = -3707 Counts (-101.8 N*) Tx = -1325 Counts (-0.8096 Nm*) Ty = -5930 Counts (-3.623 Nm*) Tz = 375 Counts (0.2291 Nm*) *Conversion to Calibration Units assumes scale factors according to Read Cal Info Example below
Read Cal Info	01 00 00 00 00 00 00 00 00 00 00 00 00 00 00 00 00 00 00 00	1234 02 03 000F4240 000F4240 3B9C 3B9C 6B4B 0263 0263 0263	Calibration Force Units = N Calibration Torque Units = Nm CpF = 1000000 CpT = 1000000 sf0 (Fx) = 15260 sf1 (Fy) = 15260 sf2 (Fz) = 27467 sf3 (Tx) = 611 sf4 (Ty) = 611 sf5 (Tz) = 611
Write Transform	02 03 01 0000 0000 0064 0000 0000 005A 00 00 00 00 00	1234 02 00	Apply Tool Transform: Displacement Units = mm Rotation Units = Degrees Dx = 0, Dy = 0, Dz = 1mm Rx = 0, Ry = 0, Rz = 180° Note: Transform elements are multiplied by 100 in the command call
Write Threshold	03 02 00 10 FF 0020	1234 03 00	Set Threshold Condition 2 to compare if Fx < 488320 Counts

RDT (UDP) Examples			
Start Single-Block	1234 0001 00000000	00000000 000DE737 00000000 FFF87E18 000551F1 00027DA0 00003F56 0004B06D 00006712	Collect one sample of FT Data: RDT Sequence Number = 0 FT Sequence Number = 911159 Status = 0x0000 Fx = -492008 Counts (-0.4920 N*) Fy = 348657 Counts (0.3487 N*) Fz = 163232 Counts (0.1632 N*) Tx = 16214 Counts (0.01621 Nm*) Ty = 307309 Counts (0.3073 Nm*) Tz = 26386 Counts (0.026386 Nm*) *Conversion to Calibration Units assumes scale factors according to Read Cal Info Example above
Start Multi-Block (This example assumes RDT Buffer Size = 5, set on the Communications Page)	1234 0003 00000001	00000005 00100994 C0000000 000AE3A9 FFC3B184 F674684C FFF5189E 003E6B62 FFFFC7FE 00000006 00100998 C0000000 000ABE86 FFC3A8DB F66FAC9C FFF515B2 003E927E FFFFC918 00000007 0010099C C0000000 000A96A3 FFC39DDF F66AFC7C FFF51209 003EB7E5 FFFFCA3D 00000008 0010099F C0000000 000A7708 FFC394B9 F667781C FFF50F0E 003ED37A FFFFCB1A 00000009 001009A3 C0000000 000A4D2F FFC388B2 F662C31C FFF50B3E 003EF8A5 FFFFCC4C	Send 1 packet of FT Data (5 samples blocked per packet**)
Start Multi-Block (This example assumes RDT Buffer Size = 1, set on the Communications Page)	1234 0003 00000002	Packet 1: 00000000 002EED3E 00000000 01E31462 FFA8F56F 00064C4C 00057454 0005E8B5 000027B5 Packet 2: 00000001 002EED42 00000000 01E3142B FFA8F4CD 00064B80 00057452 0005E8B8 000027B8	Send 2 packets of FT Data (1 sample blocked per packet***)
Stop	1234 0000 00000000	None	Streaming will stop
Set Active Calibration	1234 0005 00000000	None	Set calibration 1 as active
Bias	1234 0042 00000000	None	Future data samples will be biased (zeroed) based on the current reading

6.11 ATI Website Menu Item

On the menu bar, if a user clicks the **ATI Website** button, a user goes to ATI Industrial Automation's official website. To use this feature, be sure a user network is connected to the internet.

7. Java® Demo Application

The user can collect and view F/T data through the Java® demo application on a personal computer. Install Java® version 6.0 (runtime 1.6.0) or later on the computer (download Java® from www.java.com/getjava).

7.1 Starting the Demo

Download the demo from the **Demo** page on the ATI Ethernet Axia F/T webpage:

1. Click the **Download Demo Application** button and follow the browser's instructions.
 - The file ATINetFT.jar downloads. If the browser does not automatically run the downloaded file, manually open the file on the computer.

Figure 7.1—Demo Page

System Status: Good

Demonstration Application

The demonstration application graphically displays transducer readings.

The application's features include:

- Display of transducer loading in real time as a bar graph and a 3D cube
- Ability to save transducer readings in CSV format
- Biasing of transducer readings to zero
- Reporting of communication errors

Click the *Download Demo Application* button to load and run the demo.
The IP address of this Axia is: 10.1.2.19

Download Demo Application
(61974 bytes)

The application requires Java version 6 (runtime 1.6.0) or later to run. Java can be downloaded from <http://www.java.com>. Java source code can be found in the Axia system documentation.

NOTICE: The Java® Demo requires the Ethernet F/T to have its RDT Interface enabled. RDT is enabled in the Ethernet F/T by default. For information on RDT settings, refer to [Section 6.7—Communication Page \(comm.htm\)](#).

- The demo program opens with the following window:

Figure 7.2—Ethernet IP Address Request

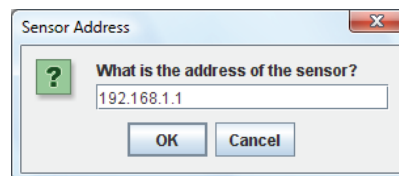

2. Type the IP address of the sensor.
 - On the **Demo** page, the IP address of the sensor is in the paragraph above the **Download Demo Application** button.
3. Click **OK**.
 - The Java® Demo application main window opens.

- If the demo is unable to make contact with the Ethernet Axia sensor, the force and torque values will display zero and the Force units and other configuration-related items will each display a question mark.

Figure 7.3—Java® Demo Application

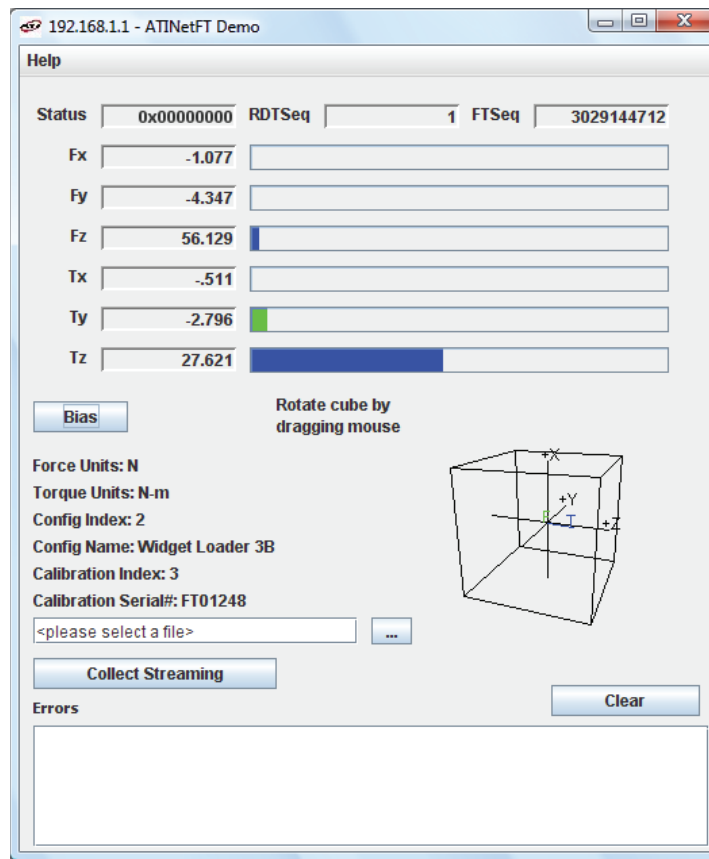

The first time the demo is used, the program may trigger a firewall alert. If this occurs with a Windows® 7/8/10 operating system, select the check boxes to give permission for the network to communicate with the sensor, and click the **Allow access** button (refer to [Figure 7.4](#)). If the network is still not connecting with the demo program, users should contact their IT department for assistance.

Figure 7.4— Windows 7/8/10 Firewall Alert

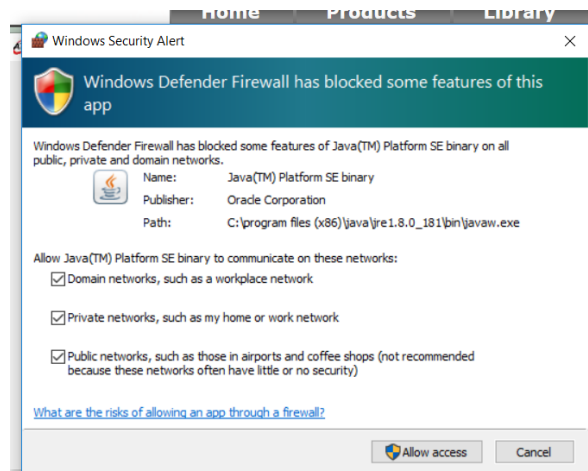

7.2 Data Display with the Demo

The main screen in [Figure 7.3](#) features a live display of the current F/T data, sequence numbers, and status code. To understand how to interpret the status code, refer to [Section 5.5—Status Code](#). During normal operation, the application requests single records, so the RDT sequence remains constant. For more information about RDT protocol, refer to [Section 12—UDP Interface Using RDT](#).

A cube in the lower screen provides a real-time visual representation of the F/T data. The user can bias the data and select the calibration configuration.

7.3 Collecting Data with the Demo

To collect F/T data, follow these steps:

1. On the Java® demo application main window, select a file to save the data by one of the following methods (refer to [Figure 7.5](#)):
 - click the “...” button to the right of the file selection field and navigate to the file destination.
 - directly type the file path into the file selection field.
2. Click the **Start Collecting** button (refer to [Figure 7.3](#)):
 - The application sends out a request for high-speed data to the Ethernet Axia sensor.
 - The user can see the RDT sequence incrementing in real-time because the application requests more than a single record when in high-speed mode.
 - The measurement data are stored in comma-separated value format (CSV) so it can be read by spreadsheets and data-analysis programs.
3. Name the file with a .CSV extension.
4. Double-click on the file to open it.

<p>NOTICE: If collecting large amounts of data, understand any limitations a spreadsheet or data analysis program may have to accommodate a certain number of rows.</p>
--

Figure 7.5—Java® Demo Application while Collecting Data

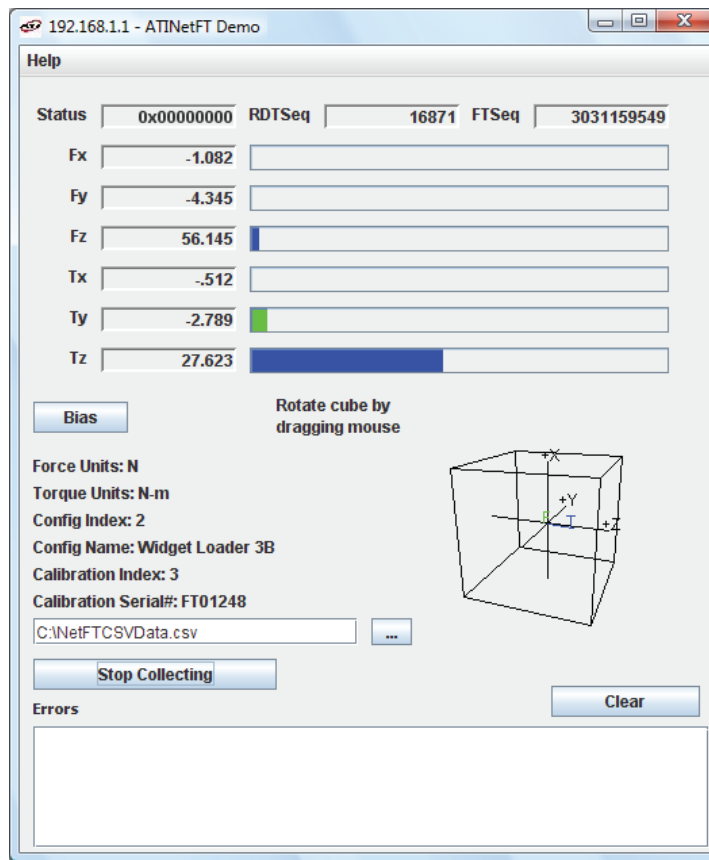

5. To stop collecting data, click the **Stop Collecting** button (the **Collect Streaming** button changes to **Stop Collecting**, during collections).

7.4 Demo CSV File Format

Information stored in the CSV file is organized as follows:

Figure 7.6—Sample Data Opened in Spreadsheet

	A	B	C	D	E	F	G	H	I	J
1	Start Time: 10/28/08 4:45 PM									
2	RDT Sample Rate: 7000									
3	Force Units: N									
4	Counts per Unit Force: 1000000.0									
5	Torque Units: N-m									
6	Counts per Unit Torque: 1000000.0									
7	Status (hex)	RDTSequence	F/T Sequence	Fx	Fy	Fz	Tx	Ty	Tz	Time
8	0x80010000	1	3031142679	-1082088	-4344421	56145954	-512907	-2789325	27622278	Tue Oct 28 16:45:31 EDT 2008
9	0x80010000	2	3031142680	-1082080	-4344397	56146508	-512897	-2790736	27622288	Tue Oct 28 16:45:31 EDT 2008
10	0x80010000	3	3031142681	-1082060	-4343688	56146485	-513175	-2791845	27621563	Tue Oct 28 16:45:31 EDT 2008
11	0x80010000	4	3031142682	-1082341	-4342832	56147539	-513359	-2791420	27621240	Tue Oct 28 16:45:31 EDT 2008
12	0x80010000	5	3031142683	-1082371	-4342861	56148597	-512138	-2790008	27621264	Tue Oct 28 16:45:31 EDT 2008
13	0x80010000	6	3031142684	-1082385	-4342524	56148628	-511978	-2790022	27621981	Tue Oct 28 16:45:31 EDT 2008
14	0x80010000	7	3031142685	-1082389	-4342191	56148118	-512436	-2789687	27622688	Tue Oct 28 16:45:31 EDT 2008
15	0x80010000	8	3031142686	-1082363	-4341816	56149196	-512870	-2791481	27622352	Tue Oct 28 16:45:31 EDT 2008
16	0x80010000	9	3031142687	-1082350	-4342498	56149183	-513193	-2791443	27622000	Tue Oct 28 16:45:31 EDT 2008
17	0x80010000	10	3031142688	-1082658	-4343039	56148680	-513432	-2789853	27623085	Tue Oct 28 16:45:31 EDT 2008
18	0x80010000	11	3031142689	-1082649	-4343057	56148669	-514051	-2788802	27623093	Tue Oct 28 16:45:31 EDT 2008
19	0x80010000	12	3031142690	-1082364	-4342864	56147033	-513374	-2790000	27622309	Tue Oct 28 16:45:31 EDT 2008
20	0x80010000	13	3031142691	-1081778	-4342833	56145442	-513406	-2792379	27622237	Tue Oct 28 16:45:31 EDT 2008
21	0x80010000	14	3031142692	-1081805	-4343552	56144381	-513136	-2790561	27622936	Tue Oct 28 16:45:31 EDT 2008
22	0x80010000	15	3031142693	-1081820	-4344608	56142267	-513644	-2789069	27623972	Tue Oct 28 16:45:31 EDT 2008
23	0x80010000	16	3031142694	-1082089	-4345096	56141691	-513861	-2789611	27622892	Tue Oct 28 16:45:31 EDT 2008
24	0x80010000	17	3031142695	-1082342	-4345231	56143795	-513900	-2790895	27621519	Tue Oct 28 16:45:31 EDT 2008
25	0x80010000	18	3031142696	-1082342	-4345217	56143265	-513897	-2791596	27621503	Tue Oct 28 16:45:31 EDT 2008
26	0x80010000	19	3031142697	-1081777	-4345564	56142209	-513490	-2792190	27621809	Tue Oct 28 16:45:31 EDT 2008
27	0x80010000	20	3031142698	-1081488	-4346106	56141657	-513765	-2790886	27621793	Tue Oct 28 16:45:31 EDT 2008

Row 1: **Start Time:** the date and time when the data collection started.

Row 2: **RDT Sample Rate:** the speed (in samples per second) at which data is sent to the host computer. The speed is the RDT Output Rate a user inputs on the **Communications** page (refer to [Section 6.7—Communication Page \(comm.htm\)](#)).

Note: If a user changes the sample rate after start of the demo program, this value does not update.

Row 3: **Force Units:** the force unit a user selected on the **Configuration** page (refer to [Section 6.6—F/T Configurations Page \(config.htm\)](#)).

Row 4: **Counts per Unit Force:** Divide all force values Fx, Fy, Fz in the CSV file by this number to calculate the force values in a user selected unit.

Row 5: **Torque Units:** the torque unit a user selected on the **Configuration** page (refer to [Section 6.6—F/T Configurations Page \(config.htm\)](#)).

Row 6: **Counts per Unit Torque:** Divide all torque values Tx, Ty, Tz in the CSV file by this number to calculate the torque values in a user selected unit.

Row 7: **Header Row:** This row names each of the columns of CSV data (refer to [Table 7.1](#)).

Table 7.1—CSV File Column Headings										
Column:	A	B	C	D	E	F	G	H	I	J
Name:	Status (hex)	RDT Sequence	F/T Sequence	Fx	Fy	Fz	Tx	Ty	Tz	Time

- Column A:** **Status (hex):** a 32-bit system status code for this row.
 To understand how to interpret the hexadecimal code and find the status code, refer to [Section 5.5—Status Code](#).
- Column B:** **RDT Sequence:** a number that starts at (1) and is incremented with each set of data that is sent from the sensor to the host computer.
 Find elapsed measurement time with the following formula:
- $$\text{Elapsed Measurement Time} = \frac{\text{RDT Sequence Number}}{\text{RDT Sample Rate}}$$
- Missing sequences indicate that data packages were lost.
 For suggestions on how to avoid lost samples, refer to [Section 13.7—Improving Ethernet Throughput](#).
- Column C:** **F/T Sequence:** a number that is incremented with each new F/T measurement. The user sets the rate on the **ADC settings** page. Refer to [Section 6.4—ADC Settings Page \(setting.htm\)](#).
- Column D:** **Fx:** the Fx axis reading in counts.
- Column E:** **Fy:** the Fy axis reading in counts.
- Column F:** **Fz:** the Fz axis reading in counts.
- Column G:** **Tx:** the Tx axis reading in counts.
- Column H:** **Ty:** the Ty axis reading in counts.
- Column I:** **Tz:** the Tz axis reading in counts.
- Column J:** **Time:** a time stamp that indicates when the demo program received the data row. This time stamp is created by a user’s computer and is limited to the clock resolution of a user’s computer.

7.5 The Errors Field Display of the Demo

On the bottom of the Java® demo application main window, an **Errors** field tracks errors that have occurred and the times they occurred (see *Figure 7.7* for an example). For assistance with troubleshooting these error messages, refer to *Section 13.4—Java® Demo Errors*. If there are excessive “IO Exception: Receive timed out errors”, refer to *Section 13.7—Improving Ethernet Throughput*.

Figure 7.7—Java® Demo Application with an Error Message

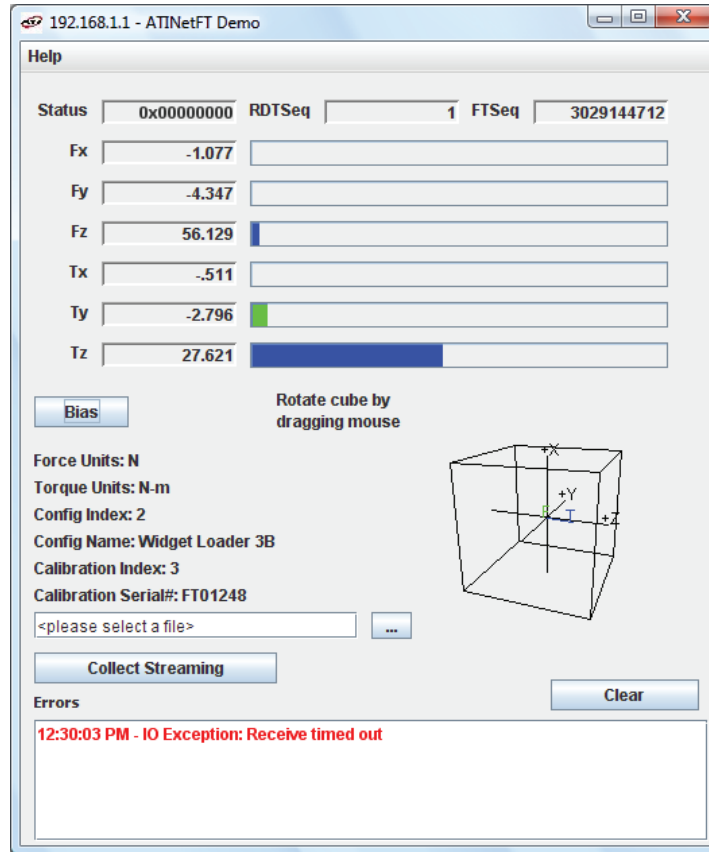

7.6 Developing a Customized Java® Application

Experienced Java® programmers can develop Ethernet F/T applications by using Java® source code that is in the 9030-05-1026 directory, which is sent to a user upon receipt of the Ethernet Axia sensor. The source code for the Java® demo is also on the ATI website at: <http://www.ati-ia.com/library/download.aspx>.

8. Console Interface Through Telnet

The Ethernet Axia sensor has a console interface that is available to a user through Telnet.

8.1 Setting Up a Console Interface Through Telnet

By using a console interface on the computer, a user can communicate with the sensor. Free Telnet console software, such as PuTTY, is available online.

For instructions on setting up a console through Telnet like PuTTY, refer to the following procedure:

1. Open the serial console, for example: PuTTY. A window opens that allows a user to set the configuration for the session.
2. Set the configuration:
 - a. Under **Connection type**: select the radio button for **Telnet**.
 - b. In the **Host Name (or IP Address)** field, enter “10.1.2.18”.
 - c. In the **Port** field, verify the default port is “23”.
 - d. Select **Open**.

Figure 8.1—Set the Configuration

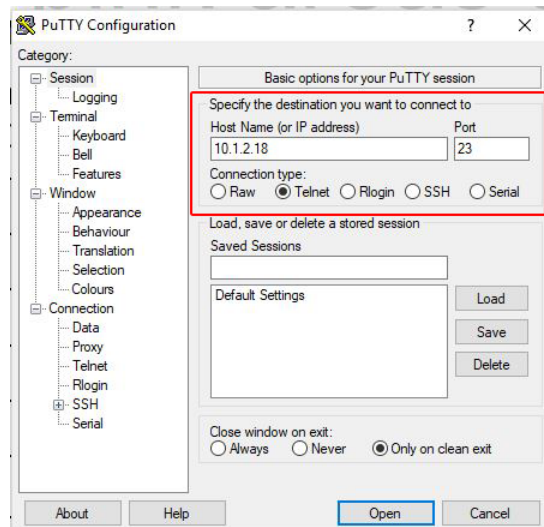

3. After a terminal window opens, the session prompts a user to enter a **Login** (or username) and **Password**. The Login is “ati”; the password is “ati7720115”.

NOTICE: Users can also log into the console with a user-defined username and password that can be set with a CAL/SET command ([Table 8.2](#)) or through the **Communications** webpage ([Section 6.7—Communication Page \(comm.htm\)](#)).

5. Type a console command from [Section 8.2—Console Commands](#), press the (enter) key to send the command.

NOTICE: Commands are not case sensitive.

Figure 8.2—PuTTY Terminal Window

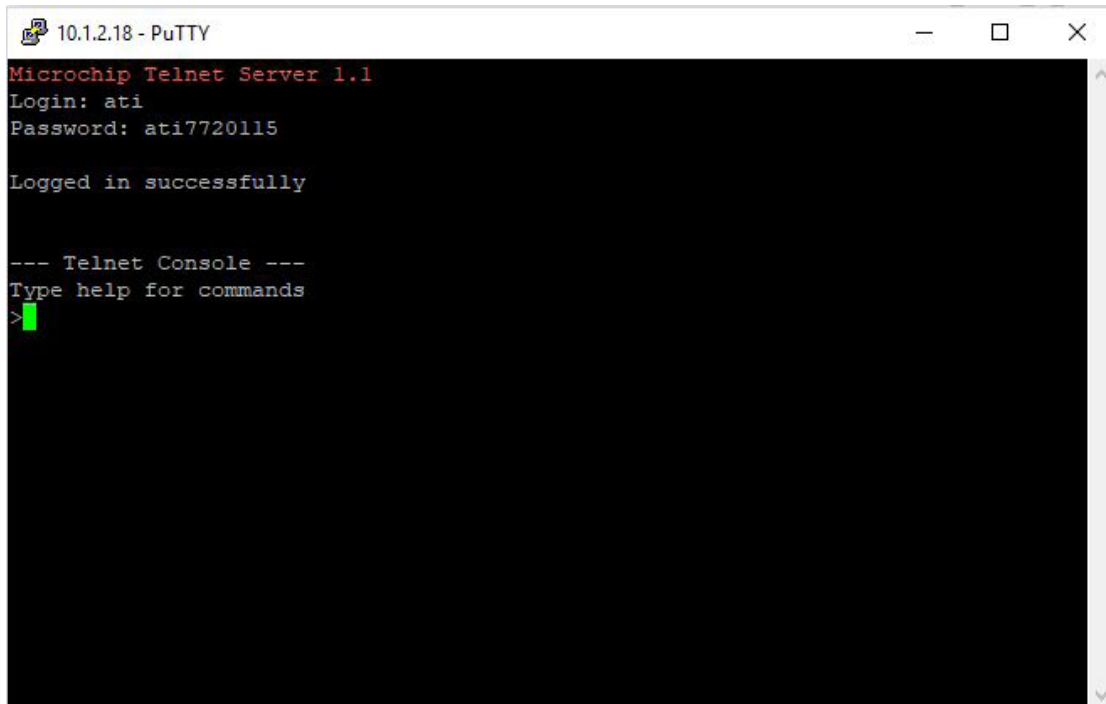

8.2 Console Commands

These console commands can be used to view the status, parameters, and adjust settings of the sensor.

Table 8.1—Commands		
Command	Operand(s)	Description
HELP	Not Applicable	The help command reports a list of the console commands and software version.
H		
MAN		
?		

Table 8.1—Commands		
Command	Operand(s)	Description
BIAS	no operand	The bias command, used without an operand, allows a user to turn the bias feature on and off.
	ON	“BIAS ON” turns the feature on and sets the F/T output to 0.
	OFF	“BIAS OFF” turns the feature off and clears the bias bit.
	[values]	The user can bias the sensor with user determined values.
PEAK	no operand	The peak command reports the highest and lowest F/T values that occurred for a run-time and for all-time, since the last peak reset command was issued. No operand reports the peaks in units.
	C	“PEAK C” reports the peaks in counts.
	R	“PEAK R” resets the run-time peaks.
S	DH!#@01234567SFTXYZMCU><; in any order	A query command reports a single line of F/T data that is scaled by the counts per force or counts per torque.
C	(refer to Section 8.4.2—Secondary Commands for the Query “C” or “S” Command)	A query command reports continuous lines of F/T data that stops when a user holds another key. If using PuTTY Telnet, press the (enter) key to stop.
CAL or SET	no operand	The “CAL” or “SET” command, used without an operand, reports all parameters.
	[field-name]	Print all matching field(s) (refer to Section 8.3—Console “CAL” “SET” Command Fields and Values).
	[field-name] [value]	Write field with value (refer to Section 8.3—Console “CAL” “SET” Command Fields and Values).
SIMERR	no operand	The simulated error command refers to bit 28 from Table 5.7 . A user can issue this command without an operand to view the status of bit 28. The simulated error command is useful for customers who need to test their error-handling routines. When a simulated error occurs, the “red” status LED turns on (refer to Section 5.2.1—Sensor Status LED).
	ON	Turns bit 28 on.
	OFF	Turns bit 28 off.
RESET	ON	This command resets the MCU.
	OFF	Turns the “reset” command off.

Table 8.1—Commands		
Command	Operand(s)	Description
SAVEALL	Not Applicable	This command records all values that remain through a power cycle to NVM.
STATUS	Not Applicable	If there could be an underlying problem within the sensor hardware, the “status” command can be used to retrieve detailed information or for a user to send the information to ATI for troubleshooting. The “status” command reports various components of the sensor. The content of this command varies among sensors.
VIEW	no operand	The “view” command reports properties such as the F/T part number, units, calibration date, and calibration family. If a user sends this command without an operand, all calibrations are reported.
	0	Calibration 0
	1	Calibration 1
	A	Active calibration
DIAG	Not Applicable	The diagnostic status command provides a report for each of the gages within the sensor. Compare this information to the values in the applicable sensor manual; refer to Table 2.1 . Use the “status” command, for troubleshooting. The report includes the following: gage number, gage readings in counts, gage status indicator, F/T axis, F/T reading in units, all-time peak data, and the active tool transformation.

8.3 Console “CAL” | “SET” Command Fields and Values

The “set” command reports all settings. Note that “CAL” is synonymous for “set”, but in this manual, the command is referenced to as “set”. Many settings are read-only fields that are configured onto the sensor during ATI factory calibration. All setting fields are listed in [Table 8.2](#).

“set” command format, for example:

```

user:      set
response:  Field                Value
          -----
          serialNum            FT22835
          partNum              SI-150-8
          calFamily            Ethernet
          ...
  
```

To read a stored parameter in NVM for a field from [Table 8.2](#), type “set [field]”, for example:

```
user:      set cpf
response:  Field                               Value
          -----
          cpf                                 100000
```

A user can send the “CAL” or “SET” command with additional fields and sometimes values to read or edit parameters such as tool transformation and calibration range. These fields and values are listed in [Table 8.2](#). All write commands are temporary until a “saveall” command is issued. When a “saveall” command is given, the parameter is stored in NVM.

Table 8.2—“set” Fields

Field	Long Name	User Read/Write	Description	Example Contents	Type
serialNum	FT Serial	Read	The FT serial number	FT001234	STRING(8)
partNum	Calibration Part Number	Read	The calibration part number	SI-150-8	STRING(30)
calFamily	Calibration Family	Read	The field always reads “Ethernet”.	Ethernet	STRING(8)
calTime	Calibration Time	Read	The date and time the sensor was calibrated.	2022-01-01 00:00	STRING(30)
max0	Max F _x Counts	Read	The maximum rated value for this axis, in F/T counts.	214748647	32-bit unsigned integer
max1	Max F _y Counts				
max2	Max F _z Counts				
max3	Max T _x Counts				
max4	Max T _y Counts				
max5	Max T _z Counts				
forceUnits	Force Units	Read	Force units: 0 = Lbf 1 = N 2 = Klbf 3 = kN 4 = Kg	1	8-bit unsigned integer
torqueUnits	Torque Units		Torque units: 0 = Lbf-in 1 = Lbf-ft 2 = Nm 3 = Nmm 4 = Kg-cm 5 = kN-m	2	

Table 8.2—"set" Fields

Field	Long Name	User Read/Write	Description	Example Contents	Type
cpf	Counts per Force	Read	Calibration counts per force unit.	1000000	32-bit unsigned integer
cpt	Counts per Torque		Calibration counts per torque unit.		
peakPos0	PeakLoadsPosF _x		All-time peak positive force/torque loads that are in F/T counts.	2395927	32-bit unsigned integer
peakPos1	PeakLoadsPosF _y			624574	
peakPos2	PeakLoadsPosF _z			0	
peakPos3	PeakLoadsPosT _x			0	
peakPos4	PeakLoadsPosT _y			159210	
peakPos5	PeakLoadsPosT _z	74910			
peakNeg0	PeakLoadsNegF _x	Read	All-time peak negative force/torque loads that are in F/T counts.	-988570	32-bit unsigned integer
peakNeg1	PeakLoadsNegF _y			-2099525	
peakNeg2	PeakLoadsNegF _z			-91487584	
peakNeg3	PeakLoadsNegT _x			-48751	
peakNeg4	PeakLoadsNegT _y			-12854	
peakNeg5	PeakLoadsNegT _z			0	
sensorHwVer	N/A	Read	The version of the sensor hardware	0	16-bit integer
adcRate	N/A	Read and Write	The ADC update rate in Hz. The ADC rate must be one of the following in units of Hz: 488 976 1953 3906 7812	976	16-bit integer
rdtRate	N/A	Read and Write	The RDT transmission rate in units of Hz. The RDT transmission rate must be 1 to the adcRate.	100	16-bit integer
rdtSize	N/A	Read and Write	The number of RDT records to include in each UDP packet that is transmitted.	1	16-bit integer
filTc	N/A	Read and Write	The IIR filter shift value.	0	8-bit integer
calib	N/A	Read and Write	The calibration to use: 0 or 1 This bit controls which of the two sets of calibrations are displayed in the preceding fields.	0	8-bit integer

Table 8.2—“set” Fields

Field	Long Name	User Read/Write	Description	Example Contents	Type
location	N/A	Read and Write	Display the physical location of the sensor.	Alex's Bench	String(40)
serNum	N/A	Read	The serial number	Serial number	String(100)
hwProdCode			The hardware product code	HW Product Code	String(20)
ttdu	N/A	Read and Write	Tool transformation distance units: 0 = in 1 = ft 2 = mm 3 = cm 4 = m	2	8-bit integer
ttau	N/A	Read and Write	Tool transformation angle units: 0 = degrees 1 = radians	0	8-bit integer
ttdx	D_x	Read and Write	Tool transform distances (in units specified by “ttdu field”)	10.5	float
ttdy	D_y			0.0	
ttdz	D_z			15.3	
ttrx	R_x		Tool transform rotation angles (in units specified by the “ttau field”)	0.0	
ttry	R_y			0.0	
ttrz	R_z			90.0	
baud	N/A	Read and Write	UART baud rate. Must be in range from 9000 baud to 3M baud. Any baud rate change is temporary until a SAVEALL command is issued.	115200	32-bit integer
msg	N/A	Read and Write	Unprompted error messages: 1 = print unprompted messages 0 = do not print unprompted messages	0	8-bit integer

Table 8.2—“set” Fields

Field	Long Name	User Read/Write	Description	Example Contents	Type
username	N/A	Read and Write	A custom user name ID and password value that can be set up to prompt a user to log into the telnet interface or to lock/unlock webpages. These fields can also be set up on the Ethernet Axia Communication webpage (Section 6.7—Communication Page (comm.htm)).	admin	String(20)
password			The default values for the username and password are “admin” and “password”. In the console interface, a user can retrieve both the username and password. On the Communication webpage, the password is hidden and only the username can be read.	password	

8.4 Query Commands: “S” or “C”

The query command starts the high-speed data transmission of F/T data. The ”S” command reports a single line of FT data that is scaled by the counts per force or counts per torque. The “C” command reports continuous lines of FT data that stop when a user holds another key, for example: “enter”, until the output of data ceases. The “C” command reports data at the rate specified in the rdtRate. The data reported by issuing a query command can be adjusted as detailed in the following section.

Query “S” command format:

```
user:      S
response:  > 34.928 N 10.234 N -0.370 N -0.1196 Nm -0.0787 Nm -0.9156 Nm
```

Query “C” command format:

```
user:      C
response:  > 34.946 N 10.277 N -0.398 N -0.1179 Nm -0.0791 Nm -0.9163 Nm
           34.915 N 10.290 N -0.419 N -0.1179 Nm -0.0793 Nm -0.9154 Nm
           34.922 N 10.253 N -0.397 N -0.1185 Nm -0.0783 Nm -0.9159 Nm
           ...
           ...
           ...
```

user: <holds another key such as ‘Enter’ and waits for the data transmission to stop>

No return data.

8.4.1 Converting Counts Per Force/Torque to FT Values

To obtain the real force and torque values, each force value must be divided by the counts per force (cpf) factor, and each torque value must be divided by the counts per torque (cpt) factor. The cpf and cpt factors can be obtained using the “set” command; refer to [Section 8.3—Console “CAL” | “SET” Command Fields and Values](#).

For example: if a calibration reports 1,000,000 counts per N and the F_z reports 4,500,000 counts, then the force applied in the Z axis is 4.5 N.

8.4.2 Secondary Commands for the Query “C” or “S” Command

The type of data reported from the query “C” or “S” command can be adjusted using secondary commands or specifiers. This feature is useful for users who want to develop their own program for storing the data to an external file or view the data in figures such as charts. A list of secondary commands is in [Table 8.3](#).

If an “S” or “C” command is issued without a specifier(s), the specifier(s) from the previous “S” or “C” command is used in the data print out. The power-on default specifier is the following: “FXYZTXYZ”.

Category	Secondary Command or Specifier	Notes
Gage number(s)	0	Gage values are printed in counts only. As many as all gage numbers can be reported or as few as a single gage number.
	1	
	2	
	3	
	4	
	5	
	6	
	7	
Axis	X	The user can choose to view force and torque data in the x, y, z axis. The output value can be displayed in F/T counts or engineering units. Counts are converted to units by scaling or dividing the count value by the cpf or cpt. Refer to Section 8.4.1—Converting Counts Per Force/Torque to FT Values .
	Y	
	Z	
Force and/or Torque	F	The XYZM force data is displayed.
	T	The XYZM torque data is displayed.
Magnitude	M	Force or torque data is displayed as the magnitude of the vector components in the x, y, and z axis. The output value can be displayed in F/T counts or engineering units. Counts are converted to units by scaling or dividing the count value by the cpf or cpt. Refer to Section 8.4.1—Converting Counts Per Force/Torque to FT Values .
Counts or Units	C	The XYZM data is displayed in counts.
	U	The XYZM data is displayed with the selected user units, for example: N or Nm. Units are the default setting.
Numeric System	H	The data is displayed as a hexadecimal number. Except any data printed in units is always displayed as a decimal number by default.
	D	The data is displayed as a decimal number.

Table 8.3—Secondary “S” or “C” Commands		
Category	Secondary Command or Specifier	Notes
Format	>	The data is displayed in a formatted human-readable output, for example: lined-up columns. “>” is the default setting.
	<	The data is displayed in a compressed output that has no leading zeros, trailing zeros, or unnecessary blanks. This output is intended for high-speed applications that are used in an automated setting.
Additional inputs to aid in the development of a software program	S	This command specifies a CRC.
	#	This command specifies a sample counter that is incremented each time that a “c” or “s” line is printed.
	@	This command specifies an ADC read counter that is incremented each time that the ADC is read.
	;	This command uses a “,” (comma) rather than a “ ” (space) to separate data values.
Troubleshooting	!	This command specifies the 32-bit status code. Refer to Section 8.4.4—How to Interpret the Output from “!” Specifier .

8.4.3 Examples of Secondary Commands (Specifiers)

The following are examples of an “S” or “C” command with specifiers:

1. C XTY is interpreted as:

```
user:          C XTY
response:      0.001 N      0.0009 Nm
```

- a. The C is a command for reporting continuous lines of data.
- b. The X specifies printing F_x , because force is the default.
- c. The T specifies printing torques whenever an X, Y, Z, or M is seen from now on (on this line).
- d. The Y specifies printing T_y .

2. C TXY is interpreted as:

```
user:          C TXY
response:      0.0009 Nm    0.0009 Nm
```

- a. The C is a command for reporting continuous lines of data.
- b. The T specifies printing torques whenever an X, Y, X, or M is seen from now on (on this line).
- c. The X specifies printing T_x .
- d. The Y specifies printing T_y .

3. S D0123 is interpreted as:

user: S D01234567

response: 246123 245592 246707 246029

- a. The S is a command for reporting a single line of data.
- b. The D specifies printing raw ADC values in counts decimal.
- c. A number 0 through 7 specifies to print the data for the corresponding gage number. For example, the 0 specifies to print data for gage 0, and the 3 specifies to print data for gage 3.

4. S CDFXYZTXYZ is interpreted as:

user: S CDFXYZTXYZ

response: 961 959 963 960 966 965

- a. The S is a command for reporting a single line of data.
- b. The C and D specifies printing x, y, z, or m F/T data in counts decimal.
- c. The F specifies printing torques whenever an X, Y, Z, or M is seen from now on (on this line).
- d. The T specifies printing the torques whenever an X, Y, Z, or M is seen from now on (on this line).

8.4.4 How to Interpret the Output from “!” Specifier

The output from “!” specifier reports an output in hexadecimal that must be converted to a 32-bit binary number that correlates to a status code from [Table 5.7](#). Refer to the following table for an example of bit patterns:

Bit Number	Simple Description (Refer to Table 5.7)	Bit Pattern
0	Temperature	0x80000001
1	Supply voltage	0x80000002
2	Broken gage	0x80000004
3	Busy bit	0x80000008
4	Reserved	N/A
5	Other	0x80000020
6	Reserved	N/A
7	Calibration Not Accessible	0x80000080
8 to 26	Reserved	N/A
27	Gage out of range	0x88000000
28	Simulated error	0x10000000
29	Calibration checksum error	0xA0000000
30	F/T out of range	0xC0000000
31	Any error	0x80000000
--	Healthy	0x00000000

If there is more than one error present, the bit pattern can be different, for example:

user: S !

response: 80000005

Using a free online calculator, a user can convert the hexadecimal number to a binary number:

Hex	8	0	0	0	0	0	0	5
Binary	1000	0000	0000	0000	0000	0000	0000	0101

The binary number has 32-bits total. The least significant bit is on the right end of the following table. “1” means the bit is on. “0” means the bit is off.

Binary Number	1	0	0	0	0	000	0000	0000	0000	0000	00	0	0	0	1	0	1
Bit Position	31	30	29	28	27	26 to 6						5	4	3	2	1	0

So in this example, bit number 0, 2 and 31 are on. According to the preceding table, the sensor has a “temperature”, “broken gage error”, and “any error” status codes. For more information, refer to [Table 5.7](#).

8.5 Example of Tool Transformation Functionality Through Telnet

For a more detailed explanation on the concept of tool transformation, refer to the applicable manual in [Table 2.1](#). For an example of how to use console commands through Telnet, refer to the following example:

A user wants to set a reference point of origin:

$D_x = -97.3$ mm $D_y = 46.1$ mm $D_z = 201.82$ mm

$R_x = +90^\circ$ rotation $R_y = +180^\circ$ rotation $R_z = 0^\circ$ rotation

1. Set the units to mm for distances and degrees for rotation:

```
user:      set ttdu 2
response:  set ttdu 2
           ttdu was 1 now 2
user:      set ttau 0
response:  set ttau 0
           ttau was 1 now 0
```

2. Write the distances and rotations:

```
user:      set ttdx -97.3
response:  set ttdx -97.3
           ttdx was "0" now "-97.3"
user:      set ttdy 46.1
response:  set ttdy 46.1
           ttdy was "0" now "46.1"
user:      set ttdz 201.82
response:  set ttdz 201.82
           ttdz was "0" now "201.82"
user:      set ttrx 90
response:  set ttrx 90
           ttrx was "0" now "90"
user:      set ttry 180
response:  set ttry 180
           ttry was "0" now "180"
user:      set ttrz 0
response:  set ttrz 0
           ttrz not changed
```

3. Send the tool transformation “tt” command:

```
user:      set tt
response:  set tt

Field      Value
-----
ttdu       2
ttau       0
ttdx       -97.3
ttdy       46.1
ttdz       201.82
ttrx       90
ttry       180
ttrz       0
```

If a user goes to the **Configuration** page on the ATI website ([Section 6.6—F/T Configurations Page \(config.htm\)](#)), the values in the **Tool Transformation** fields match these values that a user entered in the console.

9. Common Gateway Interface (CGI)

A user can configure the sensor over Ethernet by using standard CGI protocol and standard HTTP GET method which sends configuration variables and their values in the requested URL. External factors to the sensor determine the maximum length of these URLs. If a user exceeds the maximum length, an error or variables might be incorrectly set.

Each variable is only settable from the CGI page which is responsible for that variable. Each CGI page and the settable variables associated with the page are explained in the following sections and tables.

9.1 URL Syntax Construction:

A user can send commands to a URL by using the following syntax:

```
http://<netFTAddress>/<CGIPage.cgi>?<firstVariableAssignment>&<nextVariable Assignment>
```

where:

http://	indicates an HTTP request
<netFTAddress>	is the Ethernet address of the Ethernet Axia sensor
/	a separator
<CGIPage.cgi>	the name of the CGI page that holds the variables to be accessed
?	a separator marking the start of variable assignments
<firstVariableAssignment>	a variable assignment using the format described below
<&nextVariableAssignment>	a variable assignment using the following format, but the variable name is preceded by an ampersand (&).

This variable assignment is optional and may be repeated for multiple variables.

9.1.1 Assigning New Values to a Variable

A user can assign new values to a variable by using the following syntax:

```
variableName=newValue
```

where:

variableName	is the name of the variable to be assigned
=	indicates assignment
newValue	is the value to be assigned to the variable.

Text for text variables should not be enclosed in quotes.
To include the ampersand character in text for a text variable use %26.
Floating point numbers are limited to 20 characters.

- For example: `http://192.168.1.1/setting.cgi?setcfgsel=2&setuserfilter=0&setpke=1`
tells the sensor at IP address 192.168.1.1 to set CGI variables `setcfgsel` to 2, `setuserfilter` to 0, and `setpke` to 1.

9.2 CGI Variable: Settings (setting.cgi)

A user can specify certain global settings such as ADC rate, low-pass filter selection, and bias (refer to [Section 6.4—ADC Settings Page \(setting.htm\)](#) for related information).

Table 9.1—setting.cgi Variables																												
Variable Name	Allowed Values	Description	Example																									
setadcrate	integers: 488, 976, 1953, 3906, 7812 (Hz)	Sets the ADC sampling rate.	setadcrate=488																									
setuserfilter	integers: 0 to 8	Sets the cutoff frequency (percent of the ADC sample rate) of the low-pass filtering as follows:	setuserfilter=0																									
		<table border="1"> <thead> <tr> <th>Value</th> <th>Cutoff</th> <th>Value</th> <th>Cutoff</th> </tr> </thead> <tbody> <tr> <td>0</td> <td>no filter</td> <td>5</td> <td>0.51%</td> </tr> <tr> <td>1</td> <td>11.97%</td> <td>6</td> <td>0.26%</td> </tr> <tr> <td>2</td> <td>4.66%</td> <td>7</td> <td>0.12%</td> </tr> <tr> <td>3</td> <td>2.17%</td> <td>8</td> <td>0.07%</td> </tr> <tr> <td>4</td> <td>1.04%</td> <td></td> <td></td> </tr> </tbody> </table>			Value	Cutoff	Value	Cutoff	0	no filter	5	0.51%	1	11.97%	6	0.26%	2	4.66%	7	0.12%	3	2.17%	8	0.07%	4	1.04%		
		Value			Cutoff	Value	Cutoff																					
		0			no filter	5	0.51%																					
		1			11.97%	6	0.26%																					
		2			4.66%	7	0.12%																					
3	2.17%	8	0.07%																									
4	1.04%																											
setbiasn	integers: -32768 to 32767	Sets the offset value for strain gage <i>n</i> . For example, <i>setbias3=0</i> would zero the bias of the fourth strain gage (Strain gages are enumerated starting at zero.)	setbias3=0																									

9.3 Thresholding CGI (moncon.cgi)

A user can define Thresholding settings and conditions.

Table 9.2—moncon.cgi Threshold Settings			
Variable Name	Allowed Values	Description	Example
setmce	Integers: 0 or 1	Threshold statement processing: enable = 1 or disable = 0	setmce=1
mcandcodes	Integers: 0 or 1	Relay trigger: any condition is true = 0 or all conditions are true = 1	mcandcodes=1
mcfloating	Integers: 0 or 1	Relay Behavior: momentary = 1 or latching = 0	mcfloating=1
mcReset	Integer: 1	Reset latch	mcReset=1
mcresetime	Integer: 0 to 255	Relay momentary minimum-on time or a delay in a tenth (0.1) of a second: 0 seconds = 0 to 25.2 seconds = 255	mcresetime=20

Table 9.3—moncon.cgi Threshold Conditions

Variable Name ¹	Allowed Values	Description	Example		
mce <i>n</i>	Integers: 0 or 1	Threshold statement <i>n</i> : enable = 1 or disable = 0	mce0=1		
mcx <i>n</i>	Integers: -1 to 5	Selects the axis evaluated by threshold statement <i>n</i> .	mcx0=5		
		Value		Description	Menu Value
		-1		Statement disabled	blank
		0		Fx axis	Fx
		1		Fy axis	Fy
		2		Fz axis	Fz
		3		Tx axis	Tx
		4		Ty axis	Ty
5	Tz axis	Tz			
mcv <i>n</i>	Integers: -2147483648 to +2147483647	Sets the counts value to compare the current axis value by threshold statement <i>n</i> .	mcv0=20		
mcon	Hexadecimal: 0x00 to 0xFF	Sets the output code for threshold statement <i>n</i> .	mco0=0x00		
Note:					
1. where <i>n</i> is an integer ranging from 0 to 15 representing the threshold statement index					

9.4 CGI Variable: Configurations (config.cgi)

The user can set the calibration and tool transformation for the sensor (refer to [Section 6.6—F/T Configurations Page \(config.htm\)](#) for related information).

Table 9.4—config.cgi Variables

Variable Name	Allowed Values	Description		
cfgcalse	integers: 0 to 1	Sets the calibration used by the sensor.		
cfgtdu	integers: 1 to 5	The distance measurement units that are used by the configuration's tool transformation.		
		Value	Description	Menu Value
		1	inch	in
		2	foot	ft
		3	millimeter	mm
		4	centimeter	cm
cfgtau	integers: 1 to 2	The rotation units used by the configuration's tool transformation.		
		Value	Description	Menu Value
		1	degrees (°)	degrees
		2	radians	radians

Table 9.4—config.cgi Variables

Variable Name	Allowed Values	Description
cfgtfx0	Floating point	Sets the tool transformation distance D_x with the units that are specified in the variable: cftgtdu.
cfgtfx1		Sets the tool transformation distance D_y with the units that are specified in the variable: cftgtdu.
cfgtfx2		Sets the tool transformation distance D_z with the units that are specified in the variable: cftgtdu.
cfgtfx3		Sets the tool transformation distance R_x with the units that are specified in the variable: cftgtau.
cfgtfx4		Sets the tool transformation rotation R_y with the units that are specified in the variable: cftgtau.
cfgtfx5		Sets the tool transformation rotation R_z with the units that are specified in the variable: cftgtau.

9.4.1 Example of Tool Transformation Functionality Through CGI

For a more detailed explanation on the concept of tool transformation, refer to the applicable manual in [Table 2.1](#). For an example of how to send configuration variables through CGI, refer to the following example:

A user wants to set the point of reference:

$D_x = -97.3$ mm $D_y = 46.1$ mm $D_z = 201.82$ mm

$R_x = +90^\circ$ rotation $R_y = +180^\circ$ rotation $R_z = 0^\circ$ rotation

- Open a web browser and enter a URL request:

```
http://192.168.1.1/config.cgi?cftgtdu=3&cftgtau=1&cfgtfx0=-97.3&cfgtfx1=46.1&cfgtfx2=201.82&cfgtfx3=90&cfgtfx4=180&cfgtfx5=0
```

This request tells the sensor at IP address 192.168.1.1 to set CGI variables cftgtdu to 3, cftgtau to 1, cfgtfx0 to -97.3, cfgtfx1 to 46.1, cfgtfx2 to 201.82, cfgtfx3 to 90, cfgtfx4 to 180, and cfgtfx5 to 0.

If a user goes to the **Configuration** page on the ATI website ([Section 6.6—F/T Configurations Page \(config.htm\)](#)), the values in the **Tool Transformation** fields match these values that a user entered in the console.

9.5 CGI Variable: Communications (comm.cgi)

A user can set the networking options of the sensor (refer to [Section 6.7—Communication Page \(comm.htm\)](#) for more information).

Variable Name	Allowed Values	Description	
comnetdhcp	Integers: 0 or 1	Sets DHCP behavior.	
		Value	Description
		0	Use DHCP if available on network
		1	Use software-defined static IP values
comnetip	Any IPV4 address in dot-decimal notation.	Sets the static IP address to be used when DHCP is disabled.	
comnetmsk	Any IPV4 subnet mask in dot-decimal notation.	Sets the subnet mask to be used when DHCP is disabled.	
comnetgw	Any IPV4 address in dot-decimal notation.	Sets the gateway to be used when DHCP is disabled.	
comrdtbsiz	Integers: 1 to 40	RDT Buffer Mode buffer size.	

10. TCP Interface

TCP interface allows a more advanced user to write their own software to interact with the sensor. This software could be written with a programming language such as *python*[™] or *C#*. Many robots can also communicate via TCP Socket Messaging communication. For a command-line demo of C#, refer to the ATI NET F/T software download webpage: https://www.ati-ia.com/Products/ft/software/net_ft_software.aspx.

By default, the TCP interface listens on TCP port 49151. The sensor's TCP port can also be changed on the **Communications** web page (refer to [Section 6.7—Communication Page \(comm.htm\)](#)). All commands are 20 bytes in length. All responses begin with the two byte header 0x12, 0x34. The sensor is the TCP server, and the PC/robot/other device is the TCP client. The client must request TCP packets before the server sends them. For an example of TCP interface commands, also refer to [Section 6.10—Interface Example Page \(examples.htm\)](#).

10.1 Command Codes

```
READFT           = 0,    /* Read F/T values. */
READCALINFO      = 1,    /* Read calibration info. */
WRITETRANSFORM   = 2,    /* Write tool transformation. */
WRITETHRESHOLD   = 3,    /* Write monitor condition. */
```

10.2 Read F/T Command

```
{
uint8            command;    /* Must be READFT (0) . */
uint8            reserved[15]; /* Should be all 0s. */
uint16           MCEnable;   /* Bitmap of MCs to enable. */
uint16           sysCommands; /* Bitmap of system commands. */
}
```

Each bit position 0-15 in MCEnable corresponds to the monitor condition at that index. If the bit is a '1', that monitor condition is enabled. If the bit is a '0', that monitor condition is disabled.

Bit 0 of sysCommands controls the Bias. If bit 0 is a '1', the system is biased. If bit 0 is a '0', no action is taken.

Bit 1 of sysCommands controls the monitor condition latch. If bit 1 is a '1', the monitor condition latch is cleared, and monitor condition evaluation begins again. If bit 1 is a '0', no action is taken.

10.3 Read F/T Response

```
{
uint16 header;    /* always 0x1234. */
uint16 status;    /* Upper 16 bits of status code. */
int16 ForceX;     /* 16-bit Force X counts. */
int16 ForceY;     /* 16-bit Force Y counts. */
int16 ForceZ;     /* 16-bit Force Z counts. */
int16 TorqueX;    /* 16-bit Torque X counts. */
int16 TorqueY;    /* 16-bit Torque Y counts. */
int16 TorqueZ;    /* 16-bit Torque Z counts. */
}
```

The status code is the upper 16 bits of the 32-bit status code.

The force and torque values in the response are equal to (actual ft value * calibration counts per unit / 16-bit scaling factor). The counts per unit and scaling factor are read using the read calibration information command.

10.4 Read Calibration Info Command

```
{  
    uint8 command;           /* Must be READCALINFO (1). */  
    uint8 reserved[19];     /* Should be all 0s. */  
}
```

10.5 Read Calibration Info Response

```
{  
    uint16 header;          /* always 0x1234. */  
    uint8 forceUnits;       /* Force Units. */  
    uint8 torqueUnits;      /* Torque Units. */  
    uint32 countsPerForce;  /* Calibration Counts per force unit. */  
    uint32 countsPerTorque; /* Calibration Counts per torque unit. */  
    uint16 scaleFactors[6]; /* Further scaling for 16-bit counts. */  
}
```

The status code is the upper 16 bits of the 32-bit status code.

The force and torque values in the response are equal to (actual ft value * calibration counts per unit / 16-bit scaling factor). The counts per unit and scaling factor are read using the read calibration information command, or viewed from the sensor's **Configuration** webpage ([Section 6.6—F/T Configurations Page \(config.htm\)](#)). These values are dependent on the sensor's model and calibration size. It is best practice to read them off the sensor, not hard code them into the user software.

The force unit codes are:

- 1: Pound
- 2: Newton
- 3: Kilopound
- 4: Kilonewton
- 5: Kilogram
- 6: Gram

The torque unit codes are:

- 1: Pound-inch
- 2: Pound-foot
- 3: Newton-meter
- 4: Newton-millimeter
- 5: Kilogram-centimeter
- 6: Kilonewton-meter

10.6 Write Tool Transform Command

With TCP, more advanced users can write their own software to set up a defined point of reference. For most users, the most efficient method to use the tool transformation functionality is through either the ATI webpages ([Section 6.6—F/T Configurations Page \(config.htm\)](#)) or a Telnet console ([Section 8.5—Example of Tool Transformation Functionality Through Telnet](#)).

```
{  
    uint8 command;          /* Must be WRITETRANSFORM (2). */  
    uint8 transformDistUnits; /* Units of dx,dy,dz */  
    uint8 transformAngleUnits; /* Units of rx,ry,rz */  
    int16 transform[6];     /* dx, dy, dz, rx, ry, rz */  
    uint8 reserved[5];     /* Should be all zeroes. */  
}
```

The 'transform' elements are multiplied by 100 to provide good granularity with integer numbers.

The distance unit codes are:

- 1: Inch
- 2: Foot
- 3: Millimeter
- 4: Centimeter
- 5: Meter

The angle unit codes are:

- 1: Degrees
- 2: Radians

The response is a standard Write Response.

10.7 Write Monitor Condition Command

```
{  
    uint8 command;          /* Must be WRITETHRESHOLD. */  
    uint8 index;           /* Index of monitor condition. 0-31. */  
    uint8 axis;            /* 0 = fx, 1 = fy, 2 = fz, 3 = tx, 4 = ty, 5 = tz. */  
    uint8 outputCode;     /* Output code of monitor condition. */  
    int8 comparison;      /* Comparison code. 1 for "greater than" (>), -1  
                          for "less than" (<). */  
    int16 compareValue;   /* Comparison value, divided by 16 bit  
                          Scaling factor. */  
    uint8 reserved[13];   /* Should be all zeroes. */  
}
```

10.8 Write Response

```
{  
    uint16 header;        /* Always 0x1234. */  
    uint8 commandEcho;   /* Echoes command. */  
    uint8 status;        /* 0 if successful, nonzero if not. */  
}
```

11. XML Interface

A user application can retrieve the sensor settings in XML format by using standard Ethernet HTTP requests. This enables programs to read system settings such as the Counts per Force value. The Java® demo application uses data from these XML pages to correctly scale displayed data.

In the following tables, the data types of XML elements are as follows:

Table 11.1—Types Used by XML Elements	
Data Type	Description
DINT	Signed double integer (32 bit)
ENABL	Boolean using <i>Enabled</i> to represent 1 and <i>Disabled</i> to represent 0
HEX n	Hexadecimal number of n bits, prefixed with <i>0x</i>
INT	Signed integer (16 bit)
REAL	Floating-point number (32 bit)
SINT	Signed short integer (8 bit)
STRING n	String of n characters
UDINT	Unsigned double integer (32 bit)
UINT	Unsigned integer (16 bit)
USINT	Unsigned short integer (8 bit)

The values of all data types are presented as an ASCII strings.

Arrays are represented if the suffix $[i]$ is attached to the data type, where i indicates the number of values in the array. Array values in an XML element may be separated by a semicolon, comma, or space.

11.1 System and Configuration Information (netftapi2.xml)

The XML page netftapi2.xml retrieves the system setup and active configuration.

The reference column in [Table 11.2](#) indicates which .htm page and .cgi function access this element. Refer to the corresponding entry in [Section 6—ATI Ethernet Axia Webpages Interface](#) or [Section 9—Common Gateway Interface \(CGI\)](#) for related information.

Table 11.2—XML Elements in netftapi2.xml			
XML Element	Data Type	Description	Reference
runstat	HEX32	System status code	—
runft	DINT[6]	Force and torque values in counts	rundata
runsg	INT[6]	Strain gage values	
runmtx	REAL	Matrix value	
runmcb	HEX32	Threshold breached	
runmco	HEX8	Threshold output	
runmcl	USINT	Threshold latched	
unbiasedsg	INT	Unbiased strain gage values	
setbias	DINT[6]	Software bias vector	setting
setrate	USINT	Set the ADC rate	
setiirshift	USINT	Set a filter	

Table 11.2—XML Elements in netftapi2.xml			
XML Element	Data Type	Description	Reference
setmce	USINT	Threshold processing status	moncon
mce	USINT[16]	Threshold statements' individual enabling	
mcx	USINT[16]	Threshold statements' selected axes	
mcc	USINT[16]	Threshold statements' comparisons	
mcv	DINT[16]	Threshold statements' counts values for comparison	
mco	HEX8[16]	Threshold statements' output codes	
cfgcalsel	USINT	Calibration used by active configuration	config
cfgcalsn	STRING8	Serial number of active configuration's calibration	
cfgfu	USINT	Force units used by active configuration	
scfgfu	STRING8	Name of force units used by active configuration	
cfgtu	USINT	Torque units used by active configuration	
scfgtu	STRING8	Name of torque units used by active configuration	
cfgtdu	USINT	Tool transformation distance units that are used by an active configuration.	
scfgtdu	STRING16	Name of tool transformation distance units that are used by an active configuration.	
cfgtau	USINT	Tool transformation rotation units that are used by an active configuration.	
scfgtau	STRING8	Name of tool tranformation rotation units that are used by an active configuration.	
cfgtfx	REAL[6]	Tool transformation distances and rotations that are applied by active configuration.	comm
comnetdhcp	ENABL	DHCP behavior setting	
comnetip	STRING15	Static IP address	
comnetmsk	STRING15	Static IP subnet mask	
comnetgw	STRING15	Static IP gateway	
nethwaddr	STRING17	Ethernet MAC address	
commrdrate	UDINT	RDT output rate	
comrdtbsiz	USINT	RDT Buffer Mode buffer size	
mfgdighwa	STRING17	Ethernet MAC Address	manuf
mfgdignsn	STRING8	Digital board serial number	
mfgdigver	STRING8	Digital board firmware revision	
mfgdigrev	STRING8	Digital board hardware revision	manuf
mfgtxdmdl	STRING16	Analog board location	
netip	STRING15	IP address in use	
runrate	UDINT	Internal sample rate for strain gage collection	—

11.2 Calibration Information (netftcalapi.xml)

The XML page netftcalapi.xml retrieves information about a specific calibration. Retrieved calibration information has not been modified by any of the Ethernet Axia configuration settings.

A calibration index can be specified when requesting this calibration information. This is done by appending *?index=n* to the request, where n is the index of the desired calibration. If a calibration index is not specified the currently-used calibration will be assumed.

For example, to retrieve calibration information for the second calibration the requested page would be *netftcalapi.xml?index=1*.

Table 11.3—XML Elements in netftcalapi.xml		
XML Element	Data Type	Calibration Information
calsn	STRING8	Serial number
calpn	STRING32	Calibration type
caldt	STRING20	Calibration date
calmtx	REAL	Matrix value
calfu	USINT	Force units (refer to config.cgi variable cfgfu for values)
scalfu	STRING8	Name of force units
caltu	USINT	Torque units used (refer to config.cgi variable cfgtu for values)
scaltu	STRING8	Name of torque units
calmr	REAL[6]	Calibrated sensing ranges in calfu and caltu units
calcpf	DINT	Counts per force unit
calcpt	DINT	Counts per torque unit
calrng	REAL	Calibrated sensing range

12. UDP Interface Using RDT

The Ethernet Axia can output data at up to 7912 Hz over Ethernet using UDP. This method of fast data collection is called Raw Data Transfer (RDT). RDT provides the following data in a packet: forces, torques, and status codes of the Ethernet Axia. Example of RDT (UDP) commands are in the following sections but can also be found on the **Interface Example** page ([Section 6.10—Interface Example Page \(examples.htm\)](#)).

NOTICE: Multi-byte values must be transferred to the network high byte first and with the correct number of bytes. Some compilers align structures to large field sizes, such as 32- or 64-bit fields, and send an incorrect number of bytes. C compilers usually provide the functions *htons()*, *htonl()*, *ntohs()*, and *ntohl()* that can automatically handle byte ordering issues and provide alignment directives that force structures to place fields directly next to each other in memory. Consult the compiler's documentation for information on structure alignment.

12.1 RDT Protocol

The Ethernet Axia listens on the selected UDP port for commands. The sensor responds to the IP address and port that sent the command. The default UDP port is 49152. A user can also change the UDP port through the sensor's Communication page ([Section 6.7—Communication Page \(comm.htm\)](#)).

In the RDT protocol, there are (4) commands that are listed in following table. A command received by the Ethernet Axia sensor takes precedence over previously-received commands.

Table 12.1—RDT Commands			
Command	Code	Purpose	Command Response
Stop	0x0000	Stop sending RDT packets over UDP.	None.
Start single-block	0x0001	Start sending RDT packets over UDP to the requestor, single blocks only, regardless of the RDT buffer size setting. Use the Count field to send a specific number of packets, 0 = unlimited.	RDT record(s).
	0x0002		
Start multi-block	0x0003	Start sending RDT packets over UDP to the requestor, how many RDT packets are blocked depends on the RDT buffer size setting. Use the Count field to send a specific number of packets, 0 = unlimited.	RDT record(s).
Bias	0x0042	Set Software Bias.	None.

The sensor generates a record in a format that is specified by the RDT Output Rate“rdtRate”. The sensor groups one or more of these records into a single UDP packet. The size of the packet depends on the value of the RDT buffer size or “rdtSize”. If using buffered mode, then the number of RDT records received in a UDP packet will be equal to the RDT buffer size displayed on the Communications page. For a description of RDT Buffer Size, refer to [Section 6.7—Communication Page \(comm.htm\)](#). Command and reply formats are explained in the following sections.

12.1.1 RDT Request For Records Structure

All RDT requests have the following structure:

```
{
    Uint16 command_header = 0x1234;    // Required
    Uint16 command;                // Command to execute
    Uint32 sample_count;            // Samples to output (0 =
                                     infinite)
}
```

- Set the command field of the RDT request to a command from [Table 12.1](#).
- Set sample_count to the number of samples to output. If sample_count is set to zero, the Ethernet Axia outputs continuously until a user sends a RDT request with command set to zero.

12.1.2 RDT Records Sent Structure

In response to the request, the sensor sends RDT records with the following structure:

```
{
    Uint32 rdt_sequence;    // RDT sequence number of this packet.
    Uint32 ft_sequence;    // The record's internal
                           sequence number
    Uint32 status;        // System status code

    // Force and torque readings use counts values
    Int32 Fx;    // X-axis force
    Int32 Fy;    // Y-axis force
    Int32 Fz;    // Z-axis force
    Int32 Tx;    // X-axis torque
    Int32 Ty;    // Y-axis torque
    Int32 Tz;    // Z-axis torque
}
```

- rdt_sequence: The position of the RDT record within a single output stream. The RDT sequence number is useful for determining if any records were lost in transit. For example, in a request for 1000 records, rdt_sequence will start at 1 and run to 1000. The RDT sequence counter will roll over to zero for the increment following 4294967295 ($2^{32}-1$).
- ft_sequence: The internal sample number of the F/T record contained in this RDT record. The F/T sequence number starts at 0 when the Ethernet Axia is powered up and increments at the internal sample rate (7000 per sec). Unlike the RDT sequence number, ft_sequence does not reset to zero when an RDT request is received. The F/T sequence counter will roll over to zero for the increment following 4294967295 ($2^{32}-1$).
- status: Contains the system status code at the time of the record.
- Fx, Fy, Fz, Tx, Ty, Tz: The F/T data as counts values.

12.2 Calculating F/T Values for RDT

To obtain the real force and torque values, divide each force output value by the Counts per Force, and divide each torque output value by the Counts per Torque factor. The Counts per Force and Counts per Torque factors can be read from netftapi2.xml page. See cfcgcpf and cfcgcpt in [Section 11.1—System and Configuration Information \(netftapi2.xml\)](#). The CpF and CpT can also be read from the sensor through the TCP interface ([Section 10—TCP Interface](#)).

12.3 Multiple Clients

The RDT protocol is designed to respond to one client only. If a second client sends a command, the Ethernet Axia responds to the new client. Multiple clients could repeatedly request single packets, minimizing problems. (The Java® demo operates in this manner.)

12.4 Notes on UDP and RDT Mode

RDT communications use UDP, with its minimal overhead, to maximize throughput. UDP does not check if a package was received.

In some Ethernet network configurations, this can lead to the loss of RDT data sets. By checking the RDT sequence number of each set, it can be determined if a data set was lost. The RDT sequence number of each data set sent will be one greater than the last data set sent for that RDT request. If a received data set's RDT sequence number is not one greater than the last received data set, then a loss of data has occurred (the program must also account for rollover of the RDT sequence number).

The likelihood of data loss highly depends on the Ethernet network configuration and there are ways to reduce the probability of data loss to almost zero; for more information, refer to [Section 13.7—Improving Ethernet Throughput](#).

The maximum data latency, measured from the beginning of data acquisition to when the last data bit is sent to the Ethernet network, is less than 28 ms.

The Ethernet Axia only supports one UDP connection at a time.

12.5 Example Code

Example C code can be found on the ATI website at http://www.ati-ia.com/Products/ft/software/net_ft_software.aspx and on the file that was sent via e-mail to the customer, when the product was shipped.

13. Troubleshoot

This section includes answers to some issues that might arise when using Ethernet with the ATI F/T Axia sensor. For more troubleshooting guidance, refer to the appropriate sensor manual in [Table 2.1](#). Answers to frequently asked questions are available on the ATI website: https://www.ati-ia.com/library/documents/FT_FAQ.pdf.

Note

Please read the manual before calling customer service. Before calling, have the following information available:

1. Serial number (e.g., FT01234)
2. Sensor model (e.g., Axia90-M50)
3. Calibration (e.g., US-15-50, SI-65-6, etc.)
4. Accurate and complete description of the question or problem
 - For the status code bit map; refer to [Section 5.5—Status Code](#).
 - For checking the system’s status, issue a “Status” command (refer to [Table 8.1](#)) or view the System Information webpage (refer to [Section 6.8—System Information Page \(manuf.htm\)](#)).
5. Computer and software information (operating system, PC type, drivers, application software, and other relevant information about the application’s configuration)

If possible, be near the F/T system when calling.

For additional troubleshooting information or to speak with a customer service representative, please contact ATI at:

ATI Industrial Automation

1031 Goodworth Drive
Apex, NC 27539 USA
www.ati-ia.com

Application Engineering

Tel: +1.919.772.0115, Extension 511
Fax: +1.919.772.8259
E-mail: ft_support@novanta.com
24/7 Support: +1 855 ATI-IA 00 (+1 855-284-4200)

13.1 LED Errors

Symptom: Status LED stays red after the (20) second power up phase.	Solution: Check the sensor cable connections. Verify the sensor cable is not damaged. There may be an internal error in the sensor. Check the status code, refer to Section 5.5—Status Code .
Symptom: Status LED is red for the first (20) seconds, after power up, and then turns green.	Solution: Normal.
Symptom: The Ethernet Link/Activity LED is not green or flashing green.	Solution: Check the Ethernet cable connection. Solution: Check the Ethernet network configuration; refer to Section 4—Connecting Through Ethernet .
Symptom: All LEDs are off.	Cause: The sensor is not powered on. Solution: Check the cables and the power source for the sensor.

13.2 Ethernet Communication Questions and Errors

Question: What IP address is assigned to the sensor?	Solution: Refer to Section 4.1—IP Address Configuration for Ethernet . The Axia’s current IP address can be found using the ATI Discovery Utility which is available for download on the ATI website or on the file 9030-05-1026 that was e-mailed to the customer when the product was shipped.
Question: How can the sensor system be set to the default IP address of 192.168.1.1?	Solution: Configure the computer to communicate with the sensor at its current address by following the instructions in Section 4.1—IP Address Configuration for Ethernet . Once communication is established, reset the address to a value compatible with a user’s network. A procedure or reset button to force the Ethernet Axia sensor back to its default IP address is not available.
Symptom: DHCP is not assigning an IP address.	Cause: The user’s Ethernet connection is not properly configured. Solution: Ethernet LAN must be connected during power up. For more information, refer to Section 4—Connecting Through Ethernet . Cause: The DHCP server waits more than 30 seconds to respond, and the sensor requires the DCHIP server to react more quickly. Cause: DHCP is not selected as the IP Address Mode on the Communications page. Solution: Verify the settings on the Communications page (refer to Section 6.7—Communication Page (comm.htm)). The sensor must be power cycled when any IP Address settings are changed. For more information, refer to Section 4—Connecting Through Ethernet .
Symptom: Browser cannot find the Axia sensor on Ethernet network.	Cause: The ARP table on a user’s Windows® computer has memory of a previous device that used the same IP address as the sensor. Solution: Clear the ARP table by restarting the computer or by going to the computer’s Start menu, selecting Run..., and entering “arp -d *”. Users’ may need help from their IT department to complete these actions. Cause: The Ethernet network is not properly configured. Solution: Check the Ethernet network configuration; refer to Section 4—Connecting Through Ethernet . Cause: The network has a firewall which is blocking the sensor’s web browser pages. Solution: Users may need to contact their IT department for assistance with network settings.

13.3 Ethernet Axia Webpage Errors

Symptom: The Invalid Request page appears.	Cause: One or more entries on the previous webpage were invalid or out of range. Solution: Go back to the previous page and review the last entry. To make debugging easier, make only one change at a time.
Symptom: The HTTP 1.0 401 Error - Unauthorized page appears	Cause: The user tried to access one of the protected pages of the web server. Solution: These pages are reserved for ATI Industrial Automation maintenance.

13.4 Java® Demo Errors

Symptom: Demo displays zeros for force and torque values and displays question marks for configuration data.	Cause: The Demo program is not able to communicate with the sensor. Solution: Check IP address and restart demo.
Symptom: Excessive IO exception: Receive timed out errors	Cause: The Ethernet connection was interrupted. Solution: Verify the Ethernet cabling is not damaged and properly installed. Verify the power supply meets the requirements listed in Section 14—Specifications .
Symptom: Error message: IO exception: <path and file name> (The process cannot access the file because it is being used by another process)	Cause: Selected file for data is in use by another program. Solution: Close file or change file name and select Collect Streaming again.
Symptom: The following message appears in a window titled Java® Virtual Machine Launcher: “Could not find the main class. Program will exit.”	Cause: Computer requires a newer version of Java®. Solution: Download a newer version of Java® from www.java.com/getjava .

13.5 Basic Guidance for Troubleshooting

Basic symptoms of inaccurate data and system errors are listed in the following section. For each symptom, causes and appropriate solutions are suggested.

Symptom: Noise — jumps in F/T readings greater than 0.05% of full-scale counts.

Cause: Noise can be caused by mechanical vibrations and electrical disturbances that are possibly from a poor ground. Electrical interference can also come from a high noise output device such as a motor.

Solution: Make sure that the DC supply voltage for the Axia sensor has little to no noise superimposed. Ground the sensor by connecting the cable's shield to ground. In most setups, 0 V is also connected to the ground. Connect the robot or other fixture to the same ground.

Verify that the sensor cables do not cross over other cables. Verify the sensor cables are not within close proximity to other equipment that could generate electrical noise.

Avoid sources of mechanical noise. If not possible, apply a filter to the data as described in [Section 5.4—Low-Pass Filter](#). For more information about Noise, refer to [Section 13.6—Reducing Noise](#).

Cause: Noise can also indicate component failure within the system.

Solution: Check the status code of the sensor; refer to [Section 5.5—Status Code](#).

Perform an accuracy check as described in the applicable ATI sensor manual in [Table 2.1](#) or in [Section 4.5: How do I evaluate the accuracy of health of the sensor?](#) in the Frequently Asked Questions (FAQ) ATI document located at: https://www.ati-ia.com/library/documents/FT_FAQ.pdf.

If the sensor fails the accuracy check, return the sensor to ATI for inspection. Contact ATI at rma-admin@ati-ia.com for a Returned Materials Authorization (RMA).

Symptom: Drift — when the F/T data continues to increase or decrease after a load is removed.

Cause: Some drift from a change in temperature is normal. Drift is observed more easily in the Z axis, compared to the X and Y axes.

Solution: After powering on the sensor, allow the sensor to warm-up for approximately 30 minutes or until the sensor is at a steady state with the air and other objects that contact the sensor. Use the bias command to shift the readings back to zero. Bias regularly.

Use an insulator between the sensor and any tooling or fixtures that are at a different temperature. Avoid creating a temperature gradient across the sensor. Shield the sensor from excessive air flow.

For more information about how to avoid drift from temperature change, refer to the following ATI document: <https://www.ati-ia.com/Library/Documents/DriftExplanation.pdf>.

Symptom: Hysteresis — when the sensor is loaded from a zeroed or biased state and then the load is removed, the sensor output does not immediately return to zero.	Cause: Mechanical coupling or internal failure can cause Hysteresis which is outside of the sensor’s specified and acceptable measurement uncertainty (error) range. Solution: Verify the sensor is properly installed, fasteners are tightened, and the customer tooling is securely installed; refer to the <i>Installation Section</i> in the applicable ATI F/T sensor manual in Table 2.1 . Use the bias command to shift the readings back to zero.
Symptom: Status Code; Bit 1 - Supply voltage is out of range.	Cause: If the supply voltage is out of range, the bit is active which indicates a potential system fault or failure. Solution: Power cycle the system. Verify the power supply is within range per Section 14—Specifications .
Symptom: Status Code; Bit 3 - Busy Bit	Cause: While the sensor is busy, the Busy Bit will be ON = 1. The sensor is busy applying a change such as an ADC rate change, filter, or an active calibration. Solution: After applying changes, wait until the Busy Bit is OFF = 0. Then read data or make any other changes.
Symptom: Status Code; Bit 2, 27, or 30 - Out of Range	Cause: A load that is outside of the sensor’s calibrated measurement range has been applied to the sensor. Solution: Remove applied loads. If the errors do not go away, continue troubleshooting. Unmount the sensor. Improper mounting methods can induce high loads in the sensor. Switch to a larger calibration size, if the application requires loads outside the range of the smaller calibration size. After using the larger calibration size and without applying a load, if errors such as “Sensing Range Exceeded”, “Gage Out of Range”, or “Gage Broken” persist, the sensor is likely permanently damaged due to overload. Perform an accuracy check (refer to the applicable ATI sensor manual in Table 2.1) or refer to <i>Section 4.5: How do I evaluate the accuracy of health of the sensor?</i> in the Frequently Asked Questions (FAQ) ATI document located at: https://www.ati-ia.com/library/documents/FT_FAQ.pdf . If the sensor fails the accuracy check, return the sensor to ATI for inspection. Contact ATI at rma-admin@ati-ia.com for a Returned Materials Authorization (RMA).

Symptom: The sensor is connected but not streaming data.

Cause: The user's devices are not compatible with real time Ethernet or Telnet communication; refer to [Section 4—Connecting Through Ethernet](#) or [Section 8.1—Setting Up a Console Interface Through Telnet](#).

Solution: Verify devices are compatible; refer to [Section 4—Connecting Through Ethernet](#) or [Section 8.1—Setting Up a Console Interface Through Telnet](#).

Cause: The sensor has had a hardware or software failure.

Solution: Observe the Axia sensor LEDs; refer to [Section 8.5—Example of Tool Transformation Functionality Through Telnet](#).

Cause: The user has not requested the sensor to start streaming.

Solution: Send the proper command (via TCP, UDP, or Telnet) to start the data stream. When using ATI's NET F/T Java® Demo or F/T Data Viewer, click "Start Reading".

Symptom: The actual data output rate of the sensor is less than expected.

Cause: The user is communicating with the sensor via TCP, and the client (the robot, PC, or PLC) is not requesting packets fast enough.

Solution: TCP is a request and response type of communication. The request speed of the client is typically the limiting factor. Try configuring the client to request packets faster (more frequently).

Cause: The user is using a data collection method such as RDT via an UDP interface that is too fast for the user's device to process; refer to [Section 12—UDP Interface Using RDT](#).

Solution: Verify that the Ethernet network configuration is properly set for the device; refer to [Section 13.7—Improving Ethernet Throughput](#).

Symptom: The initial F/T values are non-zero and no load is applied.

Solution: Normal. Bias the sensor to bring all the F/T values back to zero.

Symptom: The values do not match expected values, for example: the F/T values are fluctuating but are higher than a known applied load.

Cause: The user may be viewing gage data instead of F/T data.

Solution: Gage data is not a 1:1 correlation to F/T axis data. To view F/T data, refer to [Section 8.4—Query Commands: “S” or “C”](#).

Cause: It is normal to see an offset in the data, even when unloaded.

Solution: Use the bias command to zero/tare the data.

Cause: The sensor outputs data in counts. Counts must be divided by the Counts per Force (CpF) or Counts per Torque (CpT) in order to convert them to Calibration units (such as N and Nm).

Solution: Verify if a user or user’s software is scaling the F/T values to convert into units. Use the CpF and CpT to convert the raw F/T values into units; for these count values, refer to:

- ATI webpage: [Section 6.2—Snapshot Page \(rundata.htm\)](#)
- Console via Telnet: [Section 8.3—Console “CAL” | “SET” Command Fields and Values](#)
- TCP: [Section 10.5—Read Calibration Info Response](#)
- XML: [Section 11.2—Calibration Information \(netfcalapi.xml\)](#)

Cause: If the raw F/T values are already converted into units and the values are high or nonsensical, verify that the sensor is not in one of these conditions: saturation, gage out of range, or F/T out of range. Check the status code of the sensor; refer to [Section 5.5—Status Code](#).

Solution: If the values exceed the ATI sensor’s calibration range per the ATI manual in [Table 2.1](#), the reported values are incorrect. For more information, refer to [Section 2.1: Measurement Range & Overload Limits](#) in the [Frequently Asked Questions \(FAQ\) ATI document](#).

Symptom: The sensor does not report accurate F/T data.

Cause: The sensor may have been overloaded beyond its calibration limits. For calibration limits, refer to the applicable ATI manual listed in [Table 2.1](#).

Solution: Check the status code. Error bits related to overload are: 2, 27, and 30. See solution for [Symptom—Status Code; Bit 2, 27, or 30 - Out of Range](#).

Cause: The sensor system configuration is not set up correctly in a user's software.

Solution: Verify the system is properly configured; refer to [Section 3—Installation](#) or contact ATI for assistance.

Cause: The user enabled tool transformation functionality.

A tool transformation moves the origin and coordinates of the sensor data. If the tool transformation is incorrectly applied, the F/T data is skewed.

Solution: Check if a tool transformation is applied, and adjust it if needed. If all fields are 0, tool transformation is not applied; for tool transfer commands, refer to:

- ATI webpage: [Section 6.6—F/T Configurations Page \(config.htm\)](#)
- Console via Telnet: [Section 8.3—Console “CAL” | “SET” Command Fields and Values](#)
- CGI variables: [Section 9.4—CGI Variable: Configurations \(config.cgi\)](#)
- TCP: [Section 10.6—Write Tool Transform Command](#)
- XML: [Section 11.1—System and Configuration Information \(netftapi2.xml\)](#)

For more information on the concept of tool transformation, refer to the applicable ATI manual in [Table 2.1](#).

Cause: The sensor is not properly installed, for example: improper fasteners are used, or the sensor is not mounted to a flat, stiff surface.

Solution: Verify the sensor is correctly installed; refer to the [Installation](#) and [Troubleshooting Sections](#) in the appropriate ATI F/T sensor manual listed in [Table 2.1](#).

Cause: It is normal to see an offset in the data, even when unloaded.

Solution: Use the bias command to zero/tare the data.

Cause: Mechanical coupling — an external object such as customer tooling or utilities is contacting a sensor's surface between the mounting side and tool side.

Solution: Remove any debris between the tool side and interface plate. Use proper cable management for cables and hoses; do not connect them tightly between the mounting and tool side of the sensor.

Anything that contacts surfaces such as the through hole in the sensor or cover plates on either side of the sensor induces loading or movement that could result in inaccurate F/T data.

13.6 Reducing Noise

13.6.1 Mechanical Vibration

In many cases, perceived noise is actually a real fluctuation of force and/or torque, caused by vibrations in the tooling or the robot arm. The Axia sensor offers digital low-pass filters that can dampen frequencies above a certain threshold. If digital low-pass filters are insufficient, a digital filter may be added to the application software.

13.6.2 Electrical Interference

To reduce the effects of electrical noise on the sensor, do the following:

- If interference by motors or other noise-generating equipment is observed, check the sensor's ground connections.
- If sufficient grounding is not possible or does not reduce noise, consider using the sensor's digital low-pass filters.
- Verify the power supply is Class 1 which has an earth ground connection.

13.7 Improving Ethernet Throughput

In an optimum network setup, the sensor's RDT data arrives at the host computer with no loss of data. If data samples are lost, consider the following:

13.7.1 Direct Connection between Axia Ethernet and Host

To achieve the best Ethernet performance (and avoid the loss of data packages), connect the sensor directly to the host computer. If using a switch, then try to use only one switch between sensor system and host. Avoid going through several switches or going through a hub.

13.7.2 Choice of Operating System

The Windows® operating system periodically performs housekeeping processes that can require a significant amount of processing power over a short amount of time. During these intervals, a loss of data can occur because Windows does not treat UDP data with a high enough priority. If a loss of data is not acceptable for the application, then use a real-time operating system.

13.7.3 Increasing Operating System Performance

The following items may also help increase the performance of a computer system so that it can best respond to the Ethernet Axia's fast data rates:

- **Disable software firewall.** One way to improve the Ethernet performance is to not have any software firewall activated. In some cases, this may require help from IT personnel.
- **Disable file and printer sharing.** File and printer sharing can slow down an operating system's response to Ethernet data and may lead to lost data.
- **Disable unnecessary network services.** Unnecessary network services and protocols can slow down an operating system's response to Ethernet data and may lead to lost data.
- **Use an Ethernet traffic snooter.** An Ethernet traffic snooter can detect that there are processes using up Ethernet bandwidth and potentially slowing down the response of a computer's operating system. This is an advanced technique that your IT department may need to perform. The free software program Wireshark (www.wireshark.org) is commonly used for this type of investigation.
- **Use a dedicated computer.** A dedicated measurement computer isolated from the company network is not burdened by the company network processes.

13.7.4 Avoid Logging the Host to a Company Network

Being logged onto a network requires the periodic access to the Ethernet interface by processes other than the measurement application and can lead to loss of UDP packages.

13.7.5 Use a Dedicated Network

Placing the sensor on a dedicated Ethernet network with no other devices on the network, other than the host computer, removes data collisions and gives the best network performance.

14. Specifications

14.1 Electrical Specifications

Table 14.1—Power Supply ¹				
Power Source	Voltage			Power Consumption
	Minimum	Nominal	Maximum	Maximum
DC Power	12 V	24 V	30 V	1.5 W

Notes:

- The power supply input is reverse polarity protected. If the power and ground to the power supply inputs are plugged in reverse, then the reverse polarity protection stops the incorrectly wired supply input from damaging or powering on the sensor.

14.2 Cable Specifications

14.2.1 P/N 9105-C-ZC22-ZC28-X

Table 14.2—9105-C-ZC22-ZC28-X M8, 6-pin, Female Connector to M12 A-Coded, 8-pin, Male Connector	
Parameter	Value
Voltage Rating	> 30 V
Current Rating	> 0.25 A
IP Rating	IP67 ¹
Operating Temperature Range (Min-Max)	-5°C to 70°C

Note:

- The cable is rated IP67 when the cable is connected at both ends. The IP rating of the cable may exceed the IP rating of the sensor, but the sensor IP rating remains the value listed in the sensor manual's specifications. For the applicable sensor manual, refer to [Table 2.1](#).

14.2.2 P/N 9105-C-ZC27-ZC28-X

Table 14.3—9105-C-ZC27-ZC28-X M8, 8-pin, Female Connector to M12 A-Coded, 8-pin, Male Connector	
Parameter	Value
Voltage Rating	> 30 V
Current Rating	> 0.25 A
IP Rating	IP67 ¹
Operating Temperature Range (Min-Max)	-5°C to 70°C

Note:

- The cable is rated IP67 when the cable is connected at both ends. The IP rating of the cable may exceed the IP rating of the sensor, but the sensor IP rating remains the value listed in the sensor manual's specifications. For the applicable sensor manual, refer to [Table 2.1](#).

14.2.3 P/N 9105-C-ZC28-ZC28-X

Table 14.4—9105-C-ZC28-ZC28-X M8, 8-pin, Female Connector to M12, 8-pin, Male Connector	
Parameter	Value
Voltage Rating	60 V
Current Rating	2.0 A
IP Rating (when connectors are attached at both ends)	IP67 ¹
Operating Temperature Range (Min-Max)	-40°C to 80°C
Note: 1. The cable is rated IP67 when the cable is connected at both ends. The IP rating of the cable may exceed the IP rating of the sensor, but the sensor IP rating remains the value listed in the sensor manual's specifications. For the applicable sensor manual, refer to Table 2.1 .	

14.2.4 P/N 9105-C-ZC28-U-RJ45S-X

Table 14.5—9105-C-ZC28-U-RJ45S-X 8-pin Female M12 Connector to Unterminated Wires and RJ45 Connector	
Parameter	Value
Voltage Rating	>40 V
Current Rating	> 0.25 A
IP Rating	IP64 ¹
Operating Temperature Range (Min-Max)	-5°C to 70°C
Note: 1. The cable is rated IP64 when the cable is connected at the M12 connector. The IP rating of the cable may exceed the IP rating of the sensor, but the sensor IP rating remains the value listed in the sensor manual's specifications. For the applicable sensor manual, refer to Table 2.1 .	

15. Terms and Conditions of Sale

The following Terms and Conditions are a supplement to and include a portion of ATI's Standard Terms and Conditions, which are on file at ATI and available upon request.

ATI warrants to Purchaser that force torque sensor products purchased hereunder will be free from defects in material and workmanship under normal use for a period of one (1) year from the date of shipment. The warranty period for repairs made under a RMA shall be for the duration of the original warranty, or ninety (90) days from the date of repaired product shipment, whichever is longer. ATI will have no liability under this warranty unless: (a) ATI is given written notice of the claimed defect and a description thereof with thirty (30) days after Purchaser discovers the defect and in any event, not later than the last day of the warranty period and (b) the defective item is received by ATI not later than (10) days after the last day of the warranty period. ATI's entire liability and Purchaser's sole remedy under this warranty is limited to repair or replacement, at ATI's election, of the defective part or item or, at ATI's election, refund of the price paid for the item. The foregoing warranty does not apply to any defect or failure resulting from improper installation, operation, maintenance, or repair by anyone other than ATI.

ATI will in no event be liable for incidental, consequential, or special damages of any kind, even if ATI has been advised of the possibility of such damages. ATI's aggregate liability will in no event exceed the amount paid by the purchaser for the item which is the subject of claim or dispute. ATI will have no liability of any kind for failure of any equipment or other items not supplied by ATI.

No action against ATI, regardless of form, arising out of or in any way connected with products or services supplied hereunder, may be brought more than one year after the cause of action accrued.

No representation or agreement varying or extending the warranty and limitation of remedy provisions contained herein is authorized by ATI, and may not be relied upon as having been authorized by ATI, unless in writing and signed by an executive officer of ATI.

Unless otherwise agreed in writing by ATI, all designs, drawings, data, inventions, software, and other technology made or developed by ATI in the course of providing products and services hereunder, and all rights therein under any patent, copyright, or other law protecting intellectual property, shall be and remain ATI's property. The sale of products or services hereunder does not convey any expressed or implied license under any patent, copyright, or other intellectual property right owned or controlled by ATI, whether relating to the products sold or any other matter, except for the license expressly granted below.

In the course of supplying products and services hereunder, ATI may provide or disclose to Purchaser confidential and proprietary information of ATI relating to the design, operation, or other aspects of ATI's products. As between ATI and Purchaser, ownership of such information, including without limitation any computer software provided to Purchaser by ATI, shall remain in ATI and such information is licensed to Purchaser only for Purchaser's use in operating the products supplied by ATI hereunder in Purchaser's internal business operations.

Without ATI's prior written permission, Purchaser will not use such information for any other purpose or provide or otherwise make such information available to any third party. Purchaser agrees to take all reasonable precautions to prevent any unauthorized use or disclosure of such information.

Purchaser will not be liable hereunder with respect to disclosure or use of information which: (a) is in the public domain when received from ATI, (b) is thereafter published or otherwise enters the public domain through no fault of Purchaser, (c) is in Purchaser's possession prior to receipt from ATI, (d) is lawfully obtained by Purchaser from a third party entitled to disclose it, or (f) is required to be disclosed by judicial order or other governmental authority, provided that, with respect to such to maintain the confidentiality of such information.

D. Custom Application

This modular manual section does not apply to this sensor system.

Please contact an ATI representative for assistance, if needed:

Sale, Service and Information about ATI products:

ATI Industrial Automation

1031 Goodworth Drive

Apex, NC 27539 USA

www.ati-ia.com

Tel: +1.919.772.0115

Fax: +1.919.772.8259

Application Engineering

Tel: +1.919.772.0115, Extension 511

Fax: +1.919.772.8259

E-mail: ft.support@novanta.com

24/7 Support: +1 855 ATI-IA 00 (+1 855-284-4200)